CONTAMINATED SOILS
Volume 12

CONTAMINATED SOILS

Volume 12

Acid Mine Drainage
Analysis
Arsenic
Brownfields
Heavy Metals
Miscellaneous
Perchlorate
Radionuclides
Remediation
Risk Assessment
Site Assessment
Vapor Intrusion

Edited by

Paul T. Kostecki
Edward J. Calabrese
James Dragun

ISBN-10: 0-9787640-1-3 ISBN-13: 978-0-9787640-1-3

© 2007 Annual International Conference on Soil, Sediments and Water
All rights reserved. Volume 12 Contaminated Soils, Sediments and Water

Annual International Conference on Soil, Sediments and Water
Environmental Health Sciences Department
School of Public Health and Health Sciences
N 344 Morrill Science Center
University of Massachusetts
Amherst, MA 01003 USA

The material contained in this document was obtained from independent and highly respected sources. Every attempt has been made to insure accurate, reliable information, however, the publisher cannot be held responsible for the information or how the information is applied. Opinions expressed in this book are those of the authors and/or contributors and do not reflect those of the publisher.

Contents

| | |
|--|------|
| FORWARD | v |
| CONTRIBUTING AUTHORS | vii |
| ACKNOWLEDGMENTS | xi |
| ABOUT THE EDITORS | xiii |
| PART I: ACID MINE DRAINAGE | |
| 1. SHORT-TERM AND LONG-TERM BIOREACTORS FOR ACID MINE DRAINAGE TREATMENT <i>CARMEN M. NECULITA, GÉRALD J. ZAGURY, AND VIKTORS KULNIEKS</i> | 1 |
| 2. AN OVERVIEW OF OCCURRENCE AND EVOLUTION OF ACID MINE DRAINAGE IN THE SLOVAK REPUBLIC <i>ANDREA SLESAROVA, MARIA KUSNIEROVA, ALENA LUPTAKOVA AND JOSEF ZEMAN</i> | 11 |
| PART II: ANALYSIS | |
| 3. MASSDEP'S EVALUATION OF LABORATORY PERFORMANCE BASED ON A LARGE VOC DOUBLE-BLIND STUDY: DECEMBER 13, 2005 <i>R. KENDALL MARRA AND JOHN J. FITZGERALD</i> | 21 |
| PART III: ARSENIC | |
| 4. TREATING ARSENIC-CONTAMINATED SOIL AT A FORMER HERBICIDE BLENDING FACILITY <i>AJIT K. CHOWDHURY, ROBERT R. STANFORTH AND ROSS OVERBY</i> | 45 |
| 5. DERIVATION OF SITE-SPECIFIC ARSENIC BACKGROUND IN SOIL: A CASE STUDY <i>MATTHEW J. MORTEFOLIO</i> | 51 |
| 6. USING MULTIPLE LINES OF EVIDENCE TO DEMONSTRATE THAT ELEVATED ARSENIC GROUNDWATER CONCENTRATIONS ARE NATURALLY OCCURRING <i>JOHN R. NELSON, GAIL L. BATCHELDER, MARK E. RADVILLE, AND SHERRY A. ALBERT</i> | 61 |

7. RISK AND BACKGROUND EVALUATION FOR ARSENIC IN SOIL AT A PLANNED RESIDENTIAL DEVELOPMENT
CHRISTOPHER M. TEAF, DOUGLAS J. COVERT, R. MARIE COLEMAN, MICHAEL PETROVICH, R.S. MURALI AND VINCE YARINA 77

PART IV: BROWNFIELDS

8. URBAN FILL CHARACTERIZATION AND RISK-BASED MANAGEMENT DECISIONS - A PRACTICAL GUIDE
WILLIAM R. SWANSON AND PAMELA LAMIE 83

PART V: HEAVY METALS

9. NEW APPROACH TO INACTIVE LANDFILLS CONTAINING WASTES OF MERCURY AND OTHER HEAVY METALS
JAN JAREMSKI 101
10. INVESTIGATION OF THE USE OF MINE TAILINGS FOR UNPAVED ROAD BASE CONSTRUCTION
ALI A. MAHMOOD AND CATHERINE N. MULLIGAN 107
11. SITES IN THE REPUBLIC OF SLOVENIA POLLUTED BY HEAVY METALS: STRATEGY AND ACTIONS PLANNED IN THE AREA
BRANKO DRUZINA AND ANDREJ PERC 119
12. MATHEMATICAL MODELING AND EXPERIMENTAL STUDIES ON BIOCHEMICAL CONVERSION OF CR(VI) OF TANNERY EFFLUENT TO CR(III) IN A CHEMOSTAT
K. SAMANTA, P. BHATTACHARYA, R. CHOWDHURY. 137
13. SORPTION OF ANTIMONY IN STREAM WATER BY WEATHERED AND ALTERED ROCK
SAKAE SANO, MASAYUKI SAKAKIBARA, ETSUKO CHIBA AND RIE HORI 149

PART VI: MISCELLANEOUS

14. SOYBEAN DERIVED FUEL LIQUIDS AS ADDITIVES FOR MIDDLE DISTILLATE TRANSPORTATION FUELS
GEORGE W. MUSHRUSH, DOUGLAS G. MOSE AND JOY W. BAUSERMAN 159

PART VII: PERCHLORATE

15. REMOVAL OF PERCHLORATE FROM DRINKING WATER AND ION-EXCHANGE REGENERANT BRINES
CHULHEUNG BAE, BRIAN DOUGHERTY AND STEPHEN HARRISON 163
16. LESSONS LEARNED FOR FUTURE DESIGNS FROM THERMAL TREATMENT OF PERCHLORATE IN SOIL
SHOUVIK GANGOPADHYAY, PAUL NIXON, AND SCOTT C. MICHALAK 175
17. PERCHLORATE REDUCTION IN A PACKED BED BIOREACTOR USING ELEMENTAL SULFUR
ASHISH K SAHU AND SARINA J ERGAS 189

PART VIII: RADIONUCLIDES

18. RADIOACTIVE SOIL CHARACTERIZATION OF THE STATE OF SAO PAULO, BRAZIL
GORO HIROMOTO, ANA CLAUDIA PERES, MARIA HELENA TADEI, MARCIO ROBERTO SOARES, AND LUIS REYNALDO FERRACCIU ALLEONI 197
19. INDOOR RADON: SHORT-TERM AND LONG-TERM INFLUENCE OF PROLONGED PRECIPITATION
DOUGLAS G. MOSE, GEORGE W. MUSHRUSH AND GEORGE SIAWAY 201
20. DETERMINATION OF SCREENING LEVEL FOR SOIL RADIOACTIVE CONTAMINATION
ANA CLAUDIA PERES AND GORO HIROMOTO 205

PART IX: REMEDIATION

21. THE VERSATILITY OF ORGANOCCLAYS FOR PERMEABLE BARRIERS
GEORGE R. ALTHER 213
22. THE EFFECT OF BULKING AGENT AND INITIAL CONTAMINANT CONCENTRATION ON THE BIODEGRADATION OF TOTAL PETROLEUM HYDROCARBONS
RAMONA BOODOOSINGH, CHRISTOPHER SWAN, ANNE MARIE DESMARAIS, AND DENISE M. BECKLES 219
23. USE OF HIGH CONCENTRATION MAGNESIUM SULFATE SOLUTION TO REMEDIATE PETROLEUM IMPACTED GROUNDWATER
JAMES F. CUTHBERTSON, JEFFREY A. KAESTNER, AND LYLE G. BRUCE 227
24. TECHNICAL CHALLENGES ON THE MARINE HYDRAULIC DREDGING PROJECT, NEW BEDFORD HARBOR SUPERFUND SITE
KENNETH C. GAYNOR, CAROLINE S. ROBERTS, CARL L. WILSON, STEVEN FOX, AND TERENCE P. DRISCOLL 249
25. PHYTOEXTRACTION AND PHYTOVOLATILIZATION OF ARSENIC FROM AS-CONTAMINATED SOILS BY *PTERIS VITTATA*
MASAYUKI SAKAKIBARA, AYA WATANABE, SAKAE SANO, MASAHIRO INOUE, AND TOSHIKAZU KAISE 267
26. REMEDIATION OF A CLAY CONTAMINATED WITH PETROLEUM HYDROCARBONS USING SOIL REAGENT MIXING
V. SCHIFANO AND N. THURSTON 273
27. BIODEGRADATION OF WEATHERED OIL IN SOILS WITH A LONG HISTORY OF TPH CONTAMINATION
TALAAAT BALBA, SOPHIA DORE, DONALD POPE, JENNIFER SMITH, AND ALAN WESTON 287
28. PERSULFATE DECOMPOSITION KINETICS IN THE PRESENCE OF AQUIFER MATERIALS
KANWARTEJ S. SRA, JESSICA J. WHITNEY, NEIL R. THOMSON, AND JIM F. BARKER 291
29. AN INNOVATIVE APPROACH TO PROTECTING A MUNICIPAL SUPPLY WELL – AIR/OZONE SPARGE CURTAIN RESULTS
VERN ELARTH, SCOTT RICE, ED TARTER, KENT ZENOBIA, AND NICOLE DAMIN 301

PART X: RISK ASSESSMENT

30. IMPACT OF AGING TIME ON THE RISK FROM DERMAL EXPOSURE TO SOIL
CONTAMINATED WITH PHENANTHRENE: SOIL-AGED PHENANTHRENE DERMAL
EXPOSURE RISK
MOHAMED S. ABDEL-RAHMAN, GLORIA A. SKOWRONSKI, AND RITA M. TURKALL 319
31. OVERVIEW OF PERFLUOROOCTANOIC ACID: STATE OF THE SCIENCE
BROOKE MOORE 327
32. THE DISTRIBUTION OF FISH ADVISORIES FOR MERCURY IN MASSACHUSETTS
JANE ROSE 331
33. ESTIMATION OF NATURAL RESOURCE DAMAGES FOR 23 FLORIDA CASES USING
PHYSICAL FATES AND BIOLOGICAL MODELING
JILL ROWE, DEBORAH FRENCH MCCAY AND NICOLE WHITTIER 335

PART XI: SITE ASSESSMENT

34. DIFFERENT SITE CHARACTERIZATION DUE TO TOPOGRAPHIC SITE CONDITIONS
AND HISTORIC SITE USE
RONALD RICHARDS, LESTER TYRALA, CHRISTEN SARDANO, AND JOHN ZUPKUS 347
35. DETAILED CVOC SOURCE AREA INVESTIGATION IN THE CONTEXT OF A
FRACTURED BEDROCK CONCEPTUAL SITE MODEL: A CASE STUDY
*JAMES H. VERNON, PATRICIA C. SHATTUCK, MARK D. KAUFFMAN, DREW M. CLEMENS, ROBERT
A. LEITCH, AND DONALD M. MAYNARD* 349
36. A BROWNFIELD MODEL COLLAPSES UNDER THE WEIGHT OF LITIGATION: CITY
OF WICHITA V. TRUSTEES OF THE APCO OIL CORPORATION LIQUIDATING TRUST
NEAL H. WEINFELD 359

PART XII: VAPOR INTRUSION

37. VAPOR INTRUSION ATTENUATION FACTORS BASED ON LONG TERM
MONITORING DATA
D.J. FOLKES, E.J. WANNAMAKER, AND J.P. KURTZ 371
38. THE USE OF TRACER GAS IN SOIL VAPOR INTRUSION STUDIES
PETER A. REYNOLDS 383
- INDEX 389

Forward

Each year the University of Massachusetts at Amherst hosts what has become the largest “small” environmental conference of its kind – *The Annual Conference on Contaminated Soils, Sediment, and Water*. The Amherst meeting is small enough to be manageable but broad enough in scope and expertise to educate even the most experienced engineers and scientists. It brings together academics, consulting and industry practitioners, regulators, and most importantly students to a venue that has advanced environmental restoration knowledge for 22 years. The most recent meeting in October of 2006 marked the 22nd anniversary of the conference, and in accordance with the conference’s historical statistics it was a very well-attended meeting. There were 39 states represented, and 34 countries represented. The total number of attendees was over 830, and the number of student presentations was 25.

It is not academic bias that leads me to mention the increase in the number of students attending and presenting, but rather I highlight that because it is a sign that this conference has become one of the premier learning opportunities for future professionals no matter what sector they intend to pursue. Over its duration the *Annual Conference on Contaminated Soils, Sediment, and Water* has evolved from a meeting dominated by regulators and consultants with localized attendance to a mixture of academics, practitioners, and regulators at about equal proportions from all corners of the World. The platform presentations, poster sessions, keynote and plenary talks are an exciting blend of basic science, field demonstrations, modeling exercises, and regulatory issues. However, despite the success and progress the conference has not lost its “smaller venue” simplicity that allows personal interactions amongst these professionals on a scale that is not possible at larger meetings. There is never anyone running from room to room to catch the last 10 minutes of overbooked talks with similar topics. The speakers and poster presenters are not hemmed in by tight timeframes such that in-depth discussions cannot arise. Basic science presentations easily align with practical case studies such that attendees leave each session feeling educated and prepared to use the information in their work, whatever it may be. That is why I again highlight the increase in student presentations and attendees. A conference is good when it is a forum for trading new ideas among experienced professionals already practicing the discipline, and that is where the *Annual Conference on Contaminated Soils, Sediment, and Water* started. But, a conference becomes truly great when it is a training ground for the future professionals who are still learning and refining their expertise. Students are there to capture the *best* information so that the unforeseen but likely more difficult problems encountered in the future can be handled with aplomb, and the ever-increasing number of these students demonstrates that this conference is disseminating strictly the *best* information.

This conference’s growth as a scientific and engineering leader is also exhibited by the transition of the annual Proceedings. Next year, starting with the 2007 conference, this document will become a peer-reviewed journal entitled the *Journal of the Annual International Conference on Soils, Sediments and Water*, Volume 1. This is a testament to the strength of the submissions that arise from the

conference. These Proceedings, Volume 12, again summarize new and relevant works in areas such as assessment, monitoring, remediation, toxicology, and analysis. These topics discuss contaminants including radionuclides, heavy metals and metalloids, organic compounds, and inorganic ions. Much like the conference, the papers presented encompass basic research science and case study applications, with all levels of development that fall in between those extremes. The data are presented clearly and the discussions are sure to stimulate new ideas that will ultimately benefit site restoration and environmental management.

These Proceedings are divided into twelve sections, and there are 38 technical papers presented. 114 authors have contributed to this volume, and their breadth of expertise has created a unique contribution that will be a resource to practitioners, regulators, and academics alike. The sections are: 1) Acid Mine Drainage, 2) Analysis, 3) Arsenic, 4) Brownfields, 5) Heavy Metals, 6) Miscellaneous, 7) Perchlorate, 8) Radionuclides, 9) Remediation, 10) Risk Assessment, 11) Site Assessment, and 12) Vapor Intrusion. The articles include small-scale bench studies, field case studies, modeling exercises, and issues of regulatory oversight. The conference managers, the editors, the supporters, and all contributors should be commended for such an excellent publication. It is a privilege to introduce the final volume of these Proceedings before its transformation into a peer-reviewed journal.

Kevin T. Finneran, Ph.D.
Department of Civil and Environmental Engineering
University of Illinois at Urbana-Champaign

Contributing Authors

- Mohamed S. Abdel-Rahman**, UMDNJ, New Jersey Medical School, Pharmacology and Physiology Dept., 185 South Orange Avenue, Newark, NJ 07101
- Sherry A. Albert**, Weston & Sampson Engineers, Inc., Five Centennial Drive, Peabody, MA 01960
- Luís Reynaldo Ferracciú Alleoni**, Universidade de São Paulo, Escola Superior de Agricultura Luiz de Queiroz, Av. Pádua Dias, 11 Piracicaba, SP, CEP 13418-900 Brazil
- George Alther**, Biomin, Inc., PO Box 20028, Ferndale, MI 48220
- Chulheung Bae**, Electrochemical Design Associates, Inc., 5705 Hollis Street, Emeryville, CA 94608
- Talaat Balba**, Conestoga-Rovers & Associates, 2055 Niagara Falls Blvd, Niagara Falls, NY 14303
- Jim F. Barker**, University of Waterloo, Dept of Earth Sciences, 200 University Avenue West, Waterloo, Ontario, N2L 3G1, Canada
- Gail L. Batchelder**, Loureiro Engineering Associates, Inc., 100 Northwest Drive, Plainville, CT 06062
- Joy W. Bauserman**, George Mason University, Chemistry Department, 4400 University Drive, Fairfax, VA 22030
- Denise Beckles**, University of West Indies, Dept of Chemistry, St. Augustine, Trinidad, West Indies
- P. Bhattacharya**, Jadavpur University, Chemical Engineering Department, Kolkata-700032, India
- Romana Boodoosingh**, LP 59 Tom Street, Longdenville, Trinidad and Tobago, West Indies
- Lyle G. Bruce**, BP Products North America Inc., Remediation Environmental Technology, 28100 Torch Parkway, Warrenville, Illinois 60555
- Etsuko Chiba**, Ehime University, 2-5 Bunkyo-cho, Matsuyama, 790-8577, Japan
- Ajit K. Chowdhury**, RMT Inc., 744 Heartland Trail, Madison, WI 53717-1934
- R. Chowdhury**, Jadavpur University, Chemical Engineering Department, Kolkata-700032, India
- Drew M. Clemens**, S Army Corps of Engineers, New England District, 696 Virginia Road, Concord, MA 01742-2751
- R. Marie Coleman**, Hazardous Substance & Waste Management Research, 2976 Wellington Circle West, Tallahassee, FL 32309
- Douglas J. Covert**, Hazardous Substance & Waste Management Research, 2976 Wellington Circle West, Tallahassee, FL 32309
- James F. Cuthbertson**, Delta Environmental Consultants, Inc., 39810 Grand River Avenue, Suite C-100, Novi, MI 48375
- Nicole Damin**, Stanislaus County Department of Environmental Resources, 3800 Cornucopia Way, Suite C, Modesto, CA 95358-949
- Anne-Marie Desmarais**, Tufts University, Dept of Civil and Environmental Engineering, Medford, MA 02155
- Sophia Dore**, Conestoga-Rovers & Associates, 2055 Niagara Falls Blvd, Niagara Falls, NY 14303
- Brian Dougherty**, Electrochemical Design Associates, Inc., 5705 Hollis Street, Emeryville, CA 94608

- Terence Driscoll**, Severson Environmental Services, Inc., 2749 Lockport Road, Niagara Falls, NY 14305
- Branko Druzina**, University of Ljubljana, University College for Health Care, Poljanska 22 a, 1000 Ljubljana, Slovenia
- Vern Elarth**, URS Corporation, 2870 Gateway Oaks Drive, Suite 150, Sacramento, CA 95833
- Sarina J. Ergas**, University of Massachusetts, Department of Civil and Environmental Engineering, 18 Marston Hall, Amherst, MA 01003
- John Fitzgerald**, Massachusetts Department of Environmental Protection, 205B Lowell Street, Wilmington, MA 01887
- David J. Folkes**, EnviroGroup Limited, 7009 South Potomac Street, Suite 300, Centennial, CO 80112
- Steven Fox**, Jacobs Engineering Group, Inc., 103 Sawyer Street, New Bedford, MA 02746
- Shouvik Gangopadhyay**, ECC, PB 519 Gaffney Road, Camp Edwards, MA 02542
- Kenneth C. Gaynor**, Jacobs Engineering Group, Inc., 103 Sawyer Street, New Bedford, MA 02746
- Stephan Harrison**, Electrochemical Design Associates, Inc., 5705 Hollis Street, Emeryville, CA 94608
- Goro Hiromoto**, Instituto de Pesquisas Energeticas e Nuclearer, Av. Prof. Lineu Prestes 2242, Radioactive Waste Management Laboratory, Sao Paulo, SP, CEP 05508-000, Brazil
- Rie S. Hori**, Ehime University, 2-5 Bunkyo-cho, Matusyama, 790-8577, Japan
- Masahiro Inoue**, Ehime University, 2-5 Bunkyo-cho, Matusyama 790-8577, Japan
- Jan Jaremski**, Rzeszow University of Technology, str. W. Pola 2, 35-959 Rzeszow, Poland
- Jeffrey A. Kaestner**, Delta Environmental Consultants, Inc., 6330 East 75th Street, Suite 176, Indianapolis, Indiana 46250
- Toshikazu Kaise**, Tokyo University of Pharmacy and Life Science, 1432-1 Horinouchi, Hachioji 192-0392, Japan
- Mark D. Kauffman**, ENSR International, 2 Technology Park Drive, Westford, MA 01886
- Viktors Kulnieks**, Ecole Polytechnique de Montreal, Department of Civil, Geological and Mining Engineering, PO Box 6079, Station Centre-ville, Montreal, QB H3C 3A7, Canada
- Jeffrey P. Kurtz**, EnviroGroup Limited, 7009 South Potomac Street, Suite 300, Centennial, CO 80112
- Maria Kusnierova**, Slovak Academy of Sciences, Institute of Geotechnics, Watsonova 45, Kosice 04353, Slovak Republic
- Pam Lamie**, CDM, Inc., 50 Hampshire St., Cambridge, MA 02139
- Robert A. Leitch**, US Army Corps of Engineers, New England District, 696 Virginia Road, Concord, MA 01742-2751
- Alena Luptakova**, Slovak Academy of Sciences, Institute of Geotechnics, Watsonova 45, Kosice 04353, Slovak Republic
- Ali A. Mahmood**, Concordia University, Department of Building, Civil and Environmental Engineering, EV 6.139, 1515 Ste-Catherine St., W. Montreal, Quebec H3G 2W1, Canada
- R. Kendall Marra**, Massachusetts Department of Environmental Protection, Bureau of Waste Site Cleanup, 1 Winter Street, Boston, MA 02180
- Donald M. Maynard**, The Johnson Company, Inc., 600 State St., Montpelier, VT 05602
- Deborah French McCay**, Applied Science Associates, Inc., 70 Dean Knauss Drive, Narragansett, RI 02882-1143
- Scott C. Michalak**, United States Army Corps of Engineers, 696 Virginia Road, Concord, MA 01742-2751
- Brooke Moore**, ENSR Corporation, 2 Technology Park Drive, Westford, MA 01886
- Matt Mortefolio**, NYSDEC, 9th Floor, 625 Broadway, Albany, NY 12233
- Douglas Mose**, George Mason University, Chemistry Department, 4400 University Drive, Fairfax, VA 22030
- Catherine N. Mulligan**, Concordia University, Department of Building, Civil and Environmental Engineering, S-EV 6.187, 1515 Ste-Catherine St., W. Montreal, Quebec H3G 2W1, Canada
- R.S. Murali**, Langan Engineering, 7900 Miami Lakes Drive, Suite 102, Miami, FL 33016

- George Mushrush**, George Mason University, Chemistry Department, 4400 University Drive, Fairfax, VA 22030
- Carmen M. Neculita**, Ecole Polytechnique de Montreal, Department of Civil, Geological and Mining Engineering, PO Box 6079, Station Centre-ville, Montreal, QB H3C 3A7, Canada
- John R. Nelson**, Massachusetts Water Resources Authority, 100 First Avenue, Charlestown Navy Yard, MA 02129
- Paul Nixon**, Impact Area Groundwater Study Program, 1803 West Outer Road, Camp Edwards, MA 02542
- Ross Overby**, URS Corporation, 500 12th Street, Suite 200, Oakland, CA 9469704914
- Andrej Perc**, E-NET Environment, Kajuhova 17, 1000 Ljubljana, Slovenia
- Ana Claudia Peres**, Instituto de Pesquisas Energeticas e Nuclearer, Av. Prof. Lineu Prestes 2242, Sao Paulo, SP, CEP 05508-000, Brazil
- Michael Petrovich**, Hopping Green & Sams, P.A., 123 S. Calhoun Street, Tallahassee, FL 32301
- Donald Pope**, Conestoga-Rovers & Associates, 2055 Niagara Falls Blvd, Niagara Falls, NY 14303
- Mark E. Radville**, Massachusetts Water Resources Authority, 100 First Avenue, Charlestown Navy Yard, MA 02129
- Peter Reynolds**, URS Corporation, 201 Willowbrook Blvd., Wayne, NJ 07474-0290
- Scott Rice**, URS Corporation, 2870 Gateway Oaks Drive, Suite 150, Sacramento, CA 95833
- Ronald Richards**, Shaw Environmental & Infrastructure, 100 Technology Center Drive, Stoughton, MA 02072
- Caroline S. Roberts**, Jacobs Engineering Group, Inc., 6 Otis Park Drive, Bourne, MA 02532-3870
- Jane Rose**, MA DEP, Office of Research and Standards, 1 Winter Street, Boston, MA 02108
- Jill J. Rowe**, Applied Science Associates, Inc (ASA), 70 Dean Knauss Drive, Narragansett, RI 02889
- Ashish K. Sahu**, University of Massachusetts, Department of Civil and Environmental Engineering, 18 Marston Hall, Amherst, MA 01003
- George Saiway**, George Mason University, Chemistry Department, 4400 University Drive, Fairfax, VA 22030
- Masayuki Sakakibara**, Ehime University, 2-5 Bunkyo-cho, Matsuyama 790-8577, Japan
- K. Samanta**, Jadavpur University, Chemical Engineering Department, Kolkata-700032, India
- Sakae Sano**, Ehime University, 3 Bunkyo-cho, Matsuyama 790-8577, Japan
- Christen Sardano**, Shaw Environmental & Infrastructure, 100 Technology Center Drive, Stoughton, MA 02072
- Vito Schifano**, Arcadis Geraghty and Miller International Ltd, Newmarket, CB8 7FA, UK
- Patricia Shattuck**, ENSR International, 401 Gilford Avenue, Gilford, NH 03249
- Gloria A. Skowronski**, UMDNJ, New Jersey Medical School, Pharmacology and Physiology Dept., 185 South Orange Avenue, Newark, NJ 07101
- Andrea Slesarova**, Slovak Academy of Sciences, Institute of Geotechnics, Watsonova 45, Kosice 04353, Slovak Republic
- Jennifer Smith**, Conestoga-Rovers & Associates, 2055 Niagara Falls Blvd, Niagara Falls, NY 14303
- Marcio Roberto Soares**, Universidade Federal de Sao Carlos, Centro de Ciencias Agraria, Rod. Anhanguera km 174, Araras, SP, CEP 13600-970, Brazil
- Kanwertej S. Sra**, University of Waterloo, Dept of Civil Engineering, 200 University Avenue West, Waterloo, Ontario N2L 3G1, Canada
- Robert Stanforth**, RMT Inc., 744 Heartland Trail, Madison, WI 53717-1934
- Christopher Swan**, Tufts University, Dept of Civil and Environmental Engineering, Medford, MA 02155
- Bill Swanson**, CDM, Inc., 50 Hampshire St., Cambridge, MA 02139
- Maria Helena Taddei**, Comissao Nacional de Energia Nuclear, Laboratorio de Pocos de Caldas, Rod. Andrade-Pocos de Caldas km 13, Pocos de Caldas, MG, CEP 37701-970, Brazil
- Ed Tarter**, URS Corporation, 2870 Gateway Oaks Drive, Suite 15, Sacramento, CA 95833
- Christopher Teaf**, Florida State University, Center for Biomedical & Toxicological Research and Waste Management, 2035 East Dirac Drive, Suite 226 HMB, Tallahassee, FL 32310-3700

- Neil R. Thomson**, University of Waterloo, Dept of Civil Engineering, 200 University Avenue West, Waterloo, Ontario N2L 3G1, Canada
- N. Thurston**, Arcadis Geraghty and Miller International Ltd, Newmarket, CB8 7FA, UK
- Rita M. Turkall**, UMDNJ, New Jersey Medical School, Pharmacology and Physiology Dept., 185 South Orange Avenue, Newark, NJ 07101
- Lester Tyrala**, Shaw Environmental & Infrastructure, 100 Technology Center Drive, Stoughton, MA 02072
- James H. Vernon**, ENSR International, 401 Gilford Avenue, Suite 220, Gilford, NH 03249
- Eric J. Wannamaker**, Former Address: EnviroGroup Limited, 7009 S. Potomac Street, Suite 300, Centennial, CO 80112, Currently with Gradient Corporation.
- Aya Watanabe**, Ehime University, 2-5 Bunkyo-cho, Matusyama 790-8577, Japan
- Neal H. Weinfield**, Greenberg Traurig, LLP, 77 West Wacker Drive, Suite 2500, Chicago, IL 60601
- Alan Weston**, Conestoga-Rovers & Associates, 2055 Niagara Falls Blvd, Niagara Falls, NY 14303
- Jessica J. Whitney**, University of Waterloo, Dept of Civil Engineering, 200 University Avenue West, Waterloo, Ontario N2L 3G1, Canada
- Nicole Whittier**, Applied Science Associates, Inc., 70 Dean Knauss Drive, Narragansett, RI 02882-1143
- Carl L. Wilson**, Jacobs Engineering Group, Inc., 103 Sawyer Street, New Bedford, MA 02746
- Vince Yarina**, Langan Engineering, 7900 Miami Lakes Drive, Suite 102, Miami, FL 33016
- Gerald J. Zagury**, Ecole Polytechnique de Montreal, Department of Civil, Geological and Mining Engineering, PO Box 6079, Station Centre-ville, Montreal, QB H3C 3A7, Canada
- Josef Zeman**, Masaryk University in Brno, Institute of Geological Sciences, Faculty of Science, Kotlarska 2, Brno 61137, Czech Republic
- Kent Zenobia**, URS Corporation, 2870 Gateway Oaks Drive, Sacramento, CA 95833
- John Zupkus**, Massachusetts Department of Environmental Protection, 205B Lowell Street, Wilmington, MA 01887

Acknowledgements

We wish to thank all agencies, organizations and companies that sponsored the conference. Without their generosity and assistance, the conference and this book would not have been possible.

Benefactors

*American Petroleum Institute
ENSR/AECOM*

Sponsors

*Environ
Kerfoot Technologies, Inc.
Regenesis Bioremediation Products
MA DEP
Shaw Group*

Supporters

*3M
Alpha Wood Hole Labs
AMEC Earth and Environmental Inc.
EA Engineering, Science & Technology
Environmental Remediation and Financial Services, LLC
Geovation Technologies, Inc.
Groundwater & Environmental Services, Inc
LSPA
New York DEC
The Adventus Group*

In addition, we express our deepest appreciation to the members of the Scientific Advisory Boards. The tremendous success of the conference has been result of the dedication and hard work of our board members.

2006 Scientific Advisory Board for the 22nd Annual International Conference on Soils, Sediment and Water

General Advisory Board

| | |
|------------------------|--|
| Nader Al-Awadhi | <i>Kuwait Institute for Scientific Research</i> |
| Ralph S. Baker | <i>TerraTherm, LLC</i> |
| Bruce Bauman | <i>American Petroleum Institute</i> |
| Mark Begley | <i>Environmental Management Commission</i> |
| Scott R. Blaha | <i>GE</i> |
| Carol de Groot Bois | <i>Bois Consulting Company</i> |
| William Brah | <i>University of Massachusetts</i> |
| Clifford Bruell | <i>University of Massachusetts Lowell</i> |
| Barbara Callahan | <i>University Research</i> |
| Robert H. Clemens | <i>AMEC Earth & Environmental, Inc</i> |
| Cynthia Cogan | <i>ENSR/AECOM</i> |
| Andrew Coleman | <i>Electric Power Research Institute</i> |
| Janine Commerford | <i>MA DEP</i> |
| Kathy Creighton | <i>Shaw Group</i> |
| James Dragun | <i>The Dragun Corporation</i> |
| John W. Duggan | <i>Wentworth Institute of Technology</i> |
| Mohamed Elnabarawy | |
| Kevin T. Finneran | <i>University of Illinois at Urbana/Champaign</i> |
| John Fitzgerald | <i>MA DEP</i> |
| Millie Garcia-Surette | <i>MA DEP, South East Region</i> |
| Steve Goodwin | <i>University of Massachusetts Amherst</i> |
| Erin Gorman | <i>AMEC Earth and Environmental</i> |
| Marc Grant | <i>AMEC Earth and Environmental</i> |
| Dominico Grasso | <i>The University of Vermont</i> |
| Peter R. Guest | <i>Parsons</i> |
| Eric Hince | <i>Geovation Technologies, Inc.</i> |
| Barry L. Johnson | <i>Assistant Surgeon General (ret.)</i> |
| William B. Kerfoot | <i>Kerfoot Technologies, Inc.</i> |
| Stephen S. Koenigsberg | <i>Regenesis Bioremediation Products</i> |
| Lynn Kucharski | <i>AMEC Earth and Environmental</i> |
| Bill Kucharski | <i>Ecology & Environment, Inc.</i> |
| Fayaz Lakhawala | <i>Adventus Americas, Inc</i> |
| Frank Lilley | <i>EA Engineering, Science and Technology, Inc</i> |
| Dave Ludwig | <i>Blasland, Bouck & Lee, Inc.</i> |
| Rick McCullough | <i>MA Turnpike Authority</i> |
| Chris Mitchell | <i>ENSR AECOM</i> |
| Robert Morrison | <i>DPRA, Inc.</i> |
| Ellen Moyer | <i>Greenenvironment, LLC</i> |
| Jim Mueller | <i>Adventus Americas Inc.</i> |
| Paul E. Murphy | <i>Tufts University</i> |
| Willard Murray | |
| Lee Newman | <i>University of South Carolina</i> |
| Eric Nichols | <i>LFR/Levine-Fricke</i> |
| David S. Page | <i>Bowdoin College</i> |
| Om Parkash (Dhankher) | <i>University of Massachusetts</i> |
| Gopal Pathak | <i>Birla Institute of Technology, India</i> |
| Frank Peduto | <i>Spectra Environmental Group</i> |
| Ioana G. Petrisor | <i>DPRA, Inc.</i> |
| Joseph Robb | <i>AMEC Earth & Environmental, Inc</i> |

| | |
|--------------------|--|
| Brian D. Rogers, | <i>Plexus Scientific Corporation</i> |
| Corinne E. Schultz | <i>Unity Environmental Technologies, LLC</i> |
| Julia Sechen | <i>MA DEP</i> |
| Hamilton Smith | <i>ABB Ltd</i> |
| Frank Sweet | <i>ENSR AECOM</i> |
| Christopher Teaf | <i>Florida State University</i> |
| James C. Todaro | <i>Alpha Analytical Labs</i> |
| Mark Vigneri | <i>Environmental Remediation and Financial Services, LLC</i> |
| A. Dallas Wait. | <i>Gradient Corporation</i> |
| Richard Waterman | <i>EA Engineering, Science, and Technology, Inc.</i> |
| Paul A. White | <i>Health Canada</i> |
| Katie Winogroszki | <i>3M</i> |
| Peter Woodman | <i>Risk Management Incorporated</i> |
| Ed Zillioux | <i>FPL Environmental Services</i> |

Federal Advisory Board

| | |
|-------------------|---|
| John Cullinane | <i>US Army Engineer Waterways Experimental Station</i> |
| John Glaser | <i>US Environmental Protection Agency, ORD</i> |
| Douglas W. Grosse | <i>US EPA</i> |
| Leslie Karr | <i>Naval Facilities Engineering Service</i> |
| Paul Rakowski | <i>Naval Facilities Engineering Command</i> |
| Mike Reynolds | <i>USA - Cold Regions Research and Engineering Laboratory (CRREL)</i> |
| Alex Sherrin | <i>US EPA Boston</i> |
| Mike Sowinski | <i>DPRA, Inc.</i> |
| Henry H. Tabak | <i>US EPA, ORD</i> |

We deeply appreciate the time and energy contributed by **Denise Leonard**, Conference Coordinator, throughout the year to the organization of The Annual International Conference on Soils, Sediment & Water at the University of Massachusetts, Amherst. We also, appreciate the work done by her assistant, **Holly (Dodge) Folsom**, over the last few years in her contribution to the compilation of this book and other aspects pertaining to the conference.

Thanks also go to **Rennie Nelson** Copy Editor of the Contaminated Soils Conference Proceedings since 2003.

About the Editors

Paul T. Kostecki, Vice Provost for Research Affairs, University of Massachusetts at Amherst and Associate Director, Northeast Regional Environmental Public Health Center, School of Public Health, University of Massachusetts at Amherst, received his Ph.D. from the School of Natural Resources at the University of Michigan in 1980. He has been involved with human and ecological risk assessment and risk management research for the last 14 years. Dr. Kostecki has co-authored and co-edited over 50 articles and 16 books on environmental assessment and cleanup including: Remedial Technologies for Leaking Underground Storage Tanks; Soils Contaminated by Petroleum Products; Petroleum Contaminated Soils, Vols. 1, 2, and 3; Hydrocarbon Contaminated Soils and Groundwater, Vols. 1, 2, 3 and 4; Hydrocarbon Contaminated Soils, Vols. 1, 2, 3, 4 and 5; Principles and Practices for Petroleum Contaminated Soils; Principles and Practices for Diesel Contaminated Soils, Vols. 1, 2, 3, 4 and 5; SESOIL in Environmental Fate and Risk modeling; Contaminated Soils, Vol. 1; and Risk Assessment and Environmental Fate Methodologies. Dr. Kostecki also serves as Associate Editor for the Journal of Soil Contamination, Chairman of the Scientific Advisory Board for Soil and Groundwater Cleanup Magazine, as well as an editorial board member for the journal Human and Ecological Risk Assessment.

Edward J. Calabrese is a board certified toxicologist and professor of toxicology at the University of Massachusetts School of Public Health at Amherst. Dr. Calabrese has researched extensively in the area of host factors affecting susceptibility to pollutants and has authored more than 300 papers in scholarly journals, as well as 24 books, including: Principles of Animal Extrapolation; Nutrition and Environmental Health, Vols. 1 and 2; Ecogenetic: Safe Drinking Water Act: Amendments, Regulations, and Standards; Soils Contaminated by Petroleum: Environmental and Public Health Effects; Petroleum Contaminated Soils, Vols. 1, 2 and 3; Ozone Risk Communication and Management; Hydrocarbon Contaminated Soils, Vols. 1, 2, 3, 4 and 5; Hydrocarbon Contaminated Soils and Groundwater, Vols. 1, 2, 3, and 4; Multiple Chemical Interactions; Air Toxics and Risk Assessment; Alcohol Interactions with Drugs and Chemicals; Regulating Drinking Water Quality; Biological Effects of Low Level Exposures to Chemicals and Radiation; Contaminated Soils; Diesel Fuel Contamination; Risk Assessment and Environmental Fate Methodologies; Principles and Practices for Petroleum Contaminated Soils, Vols. 1, 2, 3, 4, and 5; Contaminated Soils, Vol. 1; and Performing Ecological Risk Assessments. He has been a member of the U.S. National Academy of Sciences and NATO Countries Safe Drinking Water Committees, and the Board of Scientific Counselors for the Agency for Toxic Substances and Disease Registry (ATSDR). Dr. Calabrese also serves as Director of the Northeast Regional Environmental Public Health Center at the University of Massachusetts, Chairman of the BELLE Advisory Committee and Director of the International Hormesis Society.

James Dragun, Ph.D., is a soil chemist with extensive experience dealing with soil remediation. He has addressed the extent, danger, and/or cleanup of chemicals at sites of national and international concern such as the oil lakes caused by the 1991 Persian Gulf War (Kuwait), VX chemical warfare agent for the U.N. Weapons Inspection Program (Iraq), malfunction of the Three Mile Island Nuclear Power Plant (USA), and dioxin in Missouri (USA). Twenty-four nations including Japan, Canada, the United Kingdom, Australia, Germany, Switzerland, Italy, France, Spain, Scandinavia, and the Netherlands have utilized his expertise.

He founded and built an environmental engineering-science consulting company. For 18 years, he has led a team of specialists in chemical engineering, civil engineering, environmental engineering, geotechnical engineering, mechanical engineering, physics, plant engineering, environmental science, geology, hydrogeology, chemistry, biochemistry, toxicology, and biology. Dr. Dragun and his associates have solved environmental issues for major companies and governments in six continents (Africa, Asia, Australia, Europe, North America, and South America).

Dr. Dragun is a full Professor at the University of Massachusetts and at Wayne State University, Detroit, MI. He has authored two college textbooks and co-authored/edited eight technical books. Also, Dr. Dragun has been the Editor-in-Chief of the *International Journal of Soil and Sediment Contamination* for over 15 years.

PART I: Acid Mine Drainage

Chapter 1

SHORT-TERM AND LONG-TERM BIOREACTORS FOR ACID MINE DRAINAGE TREATMENT

Carmen M. Neculita, Gérald J. Zagury, and Viktors Kulnieks

Department of Civil, Geological and Mining Engineering, École Polytechnique de Montréal, P.O. Box 6079, Station Centre-ville, Montreal, Quebec, Canada H3C 3A7

Abstract: Passive biological treatment of acid mine drainage (AMD) relies on sulfate-reducing bacteria (SRB) supported by a biodegradable organic carbon source. However, long-term treatment performance can be limited by the degradation rates of organic carbon available to SRB, and by low metal stability in spent reactive mixtures. The first part of this study focused on characterization of six natural organic materials and their short-term effectiveness in sulfate-reduction and metal removal from synthetic AMD. In the second part, long-term performance and metal precipitates in the reactive mixtures were assessed. Maple wood chips, sphagnum peat moss, leaf compost, conifer compost, poultry manure and conifer sawdust were analyzed in terms of their carbon and nitrogen content, as well as their easily available substances content (EAS). Single substrates and substrate mixtures were tested in a 70-day batch experiment (2-L reactors) and in an extended batch study for up to 350 days. Geochemical modeling and scanning electron microscopy (SEM) was used to assess the minerals present in the solid phase. The highest EAS content and the lowest C/N ratio suggested poultry manure would be the best substrate. Nevertheless, the lowest efficiency was found in the poultry manure reactor, whereas the mixture of three organic materials was the most effective. After 350 days, the mixture of organic carbon sources was still efficient for AMD treatment. SEM analysis of the solid phase indicated the presence of iron sulfides. Substrate characterization provided insight on organic carbon availability but did not elucidate their ability to promote sulfate-reduction and metal removal. Further research is needed to accurately predict long-term carbon availability and to assess the metal precipitates in spent reactive mixtures.

Key words: acid mine drainage, sulfate-reducing bacteria, long-term passive bioreactors, mineralogical analysis.

1. INTRODUCTION

Prolonged exposure of reactive sulphide minerals (e.g. pyrite, pyrrhotite) from mine tailings to oxygen and water, in the absence of sufficient neutralizing minerals, generates acid mine drainage (AMD) (Tsukamoto et al., 2004). AMD contaminated waters are mainly characterized by low pH and high concentrations of sulfates and heavy metals. Therefore, AMD must be collected and treated to remove metals and to increase the pH before being discharged into the environment (Neculita et al., 2006).

Over the past 20 years, passive bioreactors have been successfully used for the treatment of AMD contaminated waters in pilot and full-scale projects (Reisinger et al., 2000; Reisman et al., 2003; URS Report, 2003; Kuyucak et al., 2006). They rely on sulfate-reducing bacteria (SRB), which are

anaerobic microorganisms capable of increasing the pH and alkalinity of water and of immobilizing dissolved metals by precipitating them as metal sulfides, provided there exists a biodegradable organic carbon source and a favourable biogeochemical environment. Under these conditions, organic carbon oxidation is coupled with sulphate reduction:



where CH_2O represents a short-chain organic carbon molecule available to SRB. The soluble sulfides generated in reaction (1) react with metals to form metal sulfide precipitates, essentially reversing the reactions that occurred to produce the AMD contaminated waters (Reisinger et al., 2000):



Passive bioreactors use a simple flow-through design, with an AMD feed over a solid reactive mixture acting as a source of carbon for SRB and as a physical support for microbial attachment and metal sulphide precipitation (Tsukamoto et al., 2004). Efficient reactive mixtures contain an organic carbon source (several organic/cellulosic wastes), a bacterial source or SRB inoculum (river sediment/animal manure), a solid porous medium (gravel/sand), a nitrogen source (urea) and a neutralizing agent (limestone) (Waybrant et al., 1998; Cocos et al., 2002; Zagury et al., 2006). The efficiency of passive bioreactors depends on the activity of SRB, which is mainly controlled by the composition of the reactive mixture. The most important component is the organic carbon source (Neculita et al., 2006). Many studies have attempted to predict the biodegradability of complex organic substrates by using chemical extractions (Prasad et al., 1999; Gibert et al., 2004; Zagury et al., 2006); however, they have not been totally successful.

An important objective of passive bioreactor efficiency is represented by the stability of the final wastes, which contain metal precipitates. Waste stability depends on metal speciation, which is related to metal removal mechanisms and on the form of sulphur, including sulfides and sulfates.

Metal removal mechanisms include sulfide precipitation, which is the desired mechanism; however, many mechanisms including adsorption and precipitation of metal carbonates and hydroxides occur in passive bioreactors (Zagury et al., 2006; Neculita et al., 2006). Experience has shown that metal removal mechanisms change during the life span of passive bioreactors. At the beginning of the treatment, in an oxidized or slightly reduced geochemical environment, metals are mainly removed by sorption onto organic matter and precipitation as (oxy)hydroxides and carbonates. After SRB acclimation and sulfide generation, metals are removed mainly as less soluble sulfide precipitates (Machemer et al., 1993; Herbert et al., 1998; Song, 2003; Gibert et al., 2005). Further, the more reduced the environment, the more reduced are the forms of sulfides. Amorphous FeS, greigite (Fe_3S_4), and mackinawite (FeS) are very common metastable iron sulfides that act as precursors in the formation of pyrite (FeS_2) in very reducing environments (Machemer et al., 1993). The following equations represent possible pathways of sulfide transformations (Machemer et al., 1993):



Sometimes pyrite formation might be limited by the rate of SO_4^{2-} reduction, which generates sulfides, and by Fe availability (Machemer et al., 1993).

Spent mixture analysis can provide information about how efficient the system is in removing metals, how available the metals are to remobilization, how long the system will last, and the stability of the environment over time (Machemer et al., 1993). Mineralogical analysis of wastes can provide information about the form of sulfides present. There are only a few techniques appropriate for waste mineralogical analysis because they are amorphous or sulfide concentrations are below detection limits. Scanning electron microscopy (SEM) with X-ray microanalysis is a common technique to locate and identify the metal elements in solids. In backscattered scanning electron microscopy (SEM-BSE), structures composed of heavier elements appear brighter than those of lighter ones. With the addition of Energy Dispersive X-ray Spectroscopy (EDS), microanalysis can give atomic percentage of the tested spots and then the elemental composition of the sample can be obtained with high spatial resolution.

Only a few studies have performed mineralogical analysis of wastes generated in wetlands (Machemer et al., 1993; Song, 2003) or passive bioreactors used for AMD passive treatment (Gibert et al., 2005). Using SEM-BSE, no clear evidence of crystalline sulfides was found in the study of Machemer et al. (1993). However, amorphous iron and lead sulfides were reported by Song (2003), while mackinawite and greigite were found in the study of Herbert et al. (1998). Nevertheless, a very recent study did not detect the presence of sulfides in wastes at the end of a 158 day AMD passive biological treatment (Gibert et al., 2005).

The first part of this study focused on characterization of six natural organic materials and their short-term effectiveness (over 70 days) in sulfate-reduction and metal removal from synthetic AMD. Results obtained during this first part will be very briefly presented.

In the second part, long-term performance and metal precipitates in the reactive mixtures were assessed. The objective was a physicochemical and mineralogical analysis of treated water and solids after 350 days of passive treatment in batch bioreactors, in order to assess the presence of metal sulfides and to gain insight into the long-term stability of generated wastes.

2. MATERIALS AND METHODS

2.1 Sampling and Preparation

In the first part of the study, maple wood chips, sphagnum peat moss, leaf compost, conifer compost, poultry manure, and conifer sawdust were evaluated. Nine reactive mixtures, in duplicate, containing single substrates and substrate mixtures were tested in a 70-day batch experiment. Bioreactors were 2 L glass reaction flasks, filled with 200 g of reactive mixture and 800 mL of synthetic AMD. Sampling and analyses of treated water was performed every 5-9 days for the first 70 days. More details on the first part of the study can be found in Zagury et al. (2006).

In the second part of the study, the 18 batch bioreactors were kept sealed, at room temperature ($22\pm 1^\circ\text{C}$), for a long-term assessment until day 350, when the final sampling and analyses of treated water were performed. Unfortunately, in bioreactors filled with sphagnum peat moss (2 & 2D) no more liquid was available for sampling. At the same time (day 350), the solid waste from reactor 8D, which contained (% w/w) maple wood chips (2%), leaf compost (30%), poultry manure (18%), urea (3%), sand (30%), creek sediment (15%), and calcium carbonate (2%) was separated and dried at 60°C until a constant weight was attained. After drying, solid samples were mounted on sample stubs and conductively coated by thin-film deposition of carbon tape for mineralogical analysis by SEM or used for metal content analysis after acid digestion with $\text{HNO}_3/\text{Br}_2/\text{HF}/\text{HCl}$.

2.2 Physicochemical and Mineralogical Analysis

The six organic matter sources were analyzed in terms of their carbon and nitrogen content, as well as their easily available substances content (EAS) (Zagury et al., 2006). At day 350, the treated

water was analyzed for pH and oxydo-reduction potential (ORP) using a HACH Model sensION1 portable pH/mV/temperature meter with a gel-filled pH electrode and a combination Ag/AgCl redox potential electrode. Sulphates, sulfides, alkalinity and ferrous iron were analyzed using an HACH UV-VIS DR/2010 spectrophotometer according to standard methods. Metal content (Na, K, Ca, Mg, Fe, Mn, Cd, Ni, and Zn) was determined using inductively coupled plasma atomic emission spectrometry ICP-AES (*Perkin Elmer Optima 3100*).

Results from physicochemical analyses of treated water at 0, 5, and 12 days after the beginning of the experiments were used for geochemical modeling with VMINTEQ (version 2.14).

In mineralogical analyses, solid samples prepared as described above were used for qualitative non-destructive analysis using SEM-BSE and compositional mapping (*Hitachi S-3500N* equipped with a microanalysis detector *Oxford Link-Isis*) and for quantitative destructive analyses using inductively coupled plasma atomic emission spectrometry ICP-AES (*Perkin Elmer Optima 3100*) after acid digestion.

3. RESULTS

3.1 Physicochemical Analyses

Initial chemical characterization revealed that the total organic carbon of six organic carbon sources varied from 11.5% (leaf compost) to 51% (maple wood chips), while dissolved organic carbon varied from 0.05% (conifer compost) to 6.13% (poultry manure) (see Zagury et al., 2006 for more details). In terms of biodegradability, expressed as EAS, poultry manure had the highest content (63.09%), whereas maple wood chips had the lowest content (28.34%). Furthermore, a C/N ratio of 3.3 suggested poultry manure would be the most suitable organic substrate for SRB. However, results showed that reactors 8 and 8D (mixture of carbon sources) were the most efficient for sulphate reduction and metal removal after 70 days.

Physicochemical analyses of treated water in batch bioreactors at day 350 are presented in Table 1. Results showed that five bioreactors (5D, 8, 8D, 9, and 9D) were efficient for AMD long-term treatment. These bioreactors were filled with reactive mixtures as follows: poultry manure (only one replicate), both replicates of the three organic carbon mixtures (maple wood chips, poultry manure, and leaf compost), and those of the same mixture and formaldehyde. Efficiency was indicated by neutral to slightly alkaline pH (7.68-7.74) and very low concentrations of sulfates (200-800 mg/L) and ferrous iron (9-16 mg/L). In these efficient bioreactors, a reduced geochemical environment about -300 mV or less was maintained throughout the experiments. Heavy metals (Mn, Cd, Ni, and Zn) from initial synthetic AMD were all below analytical detection limits. Moreover, bioreactors filled with the mixtures of organic carbon sources produced the highest alkalinity (36-40 g/l CaCO₃). Other organic substrates performed less satisfactory, such as bioreactors 6 & 6D, which produced 91 to 107 mg/L CaCO₃ alkalinity because of toxicity due to phenol compounds contained by conifer sawdust (Neculita et al., 2006) or 10 to 62 mg/L CaCO₃ alkalinity because of acetate accumulation, as in the ethanol containing bioreactors 7 & 7D. Therefore, as results indicated (Table 1), batches 8 & 8D were the most efficient in the long-term 350 day batch experiment. This was the reason for using the solids from bioreactor 8D for mineralogical analysis.

Table 1. Physicochemical characteristics of treated water during batch sampling after 350 days

| Reactor | Composition | Parameter | | | | | | | | |
|---------|--------------------|-----------|-------------|------------------|-------------------------------|----------|------|------|------------|------------------------------|
| | | pH | ORP (mV) | Fe ²⁺ | SO ₄ ²⁻ | Sulfides | TOC | DOC | Alkalinity | NH ₄ ⁺ |
| | | | | |mg/L..... | | | | | |
| 1 | Maple wood chips | 7.30 | +45.4 | 25 | 3167 | 0.83 | 5682 | 3994 | 125 | 3000 |
| 1D | | 7.30 | -59.2 | 5.0 | 833 | 1.70 | 4160 | 4316 | 565 | 2700 |
| 2 | Sphagnum peat moss | No liquid | | | | | | | | |
| 2D | | | | | | | | | | |
| 3 | Leaf compost | 8.13 | +40.4 | 183 | 3500 | 4.30 | 3744 | 1123 | 665 | 2400 |
| 3D | | 7.84 | +54.6 | 272 | 2500 | 0.30 | 4368 | 1196 | 715 | 2600 |
| 4 | Conifer compost | 7.80 | +55.1 | 25 | 2500 | 0.05 | 2635 | 530 | 153 | 2300 |
| 4D | | 7.69 | +24.6 | 8.3 | 3167 | 0.10 | 2642 | 478 | 101 | 2300 |
| 5 | Poultry manure | 7.36 | -301.9 | 22 | 4200 | 0.10 | 4181 | 208 | 795 | 7800 |
| 5D | | 7.74 | -419.6 | 9 | 400 | 0.20 | 9610 | 333 | 1390 | 6800 |
| 6 | Conifer sawdust | 7.86 | -14.7 | 18 | 3600 | 0.60 | 5366 | 343 | 107 | 2700 |
| 6D | | 8.26 | +16.3 | 2 | 3300 | 0.50 | 4992 | 135 | 91 | 2700 |
| 7 | Ethanol | 7.97 | -315.8 | 7 | 5100 | 0.10 | 6490 | 62 | 200 | 1700 |
| 7D | | 7.80 | -17.5 | 5 | 5500 | 0.70 | 4555 | 10 | 109 | 1600 |
| 8 | Mixture* | 7.72 | -292.9 | 16 | 200 | 0.20 | 5054 | 894 | 36000 | 4000 |
| 8D | | 7.73 | -343.2 | 17 | 300 | 0.60 | 2434 | 978 | 39500 | 3800 |
| 9 | Mixture and FA** | 7.70 | -399.1 | 27 | 800 | 0.30 | 5554 | 1030 | 36000 | 3700 |
| 9D | | 7.68 | -310.6 | 27 | 300 | 0.40 | 6739 | 1113 | 40000 | 4300 |

* Reactive mixture from bioreactors 8&8D contained (% w/w) maple wood chips (2%), leaf compost (30%), poultry manure (18%), urea (3%), sand (30%), creek sediment (15%), and calcium carbonate (2%).

** Reactive mixture from bioreactors 9&9D contained (% w/w) maple wood chips (2%), leaf compost (30%), poultry manure (18%), urea (3%), sand (30%), creek sediment (15%), and calcium carbonate (2%) and formaldehyde (0.015%w/v) to inhibit bacterial activity.

Table 2. Physicochemical characteristics of treated water and solid phase at the beginning (day 0) and at the end (day 350) of batch experiments (reactor 8D)

| Parameter | Liquid | | Parameter | Solid | |
|--------------------------------------|----------------------------|--------------------------|--------------------------------------|-------------------------------|------------------|
| | Initial (synthetic AMD) | Final (treated water) | | Initial (reactive mixture) | Final (waste) |
| pH | 3.9 – 4.2 | 7.73 | pH | - | - |
| Alkalinity (mg/L CaCO ₃) | 130 | 39 500 | Alkalinity (mg/L CaCO ₃) | - | - |
| Ca ²⁺ (mg/l) | 330 ± 20 | 93 | Ca ²⁺ (%) | 5.72 | 9.47 |
| Cd ²⁺ (mg/l) | 8.3 ± 2.0 | < 0.4 | Cd ²⁺ (%) | - | 0.002 |
| Fe ²⁺ (mg/l) | 1683 ± 35 | 17 | Fe ²⁺ (%) | 0.08 | 4.94 |
| K ⁺ (mg/l) | 55 ± 1 | 1100 | K ⁺ (%) | - | - |
| Mg ²⁺ (mg/l) | 99 ± 1 | 6 | Mg ²⁺ (%) | - | 0.831 |
| Mn ²⁺ (mg/l) | 14 ± 1 | < 0.4 | Mn ²⁺ (%) | 0.0008 | 0.046 |
| Na ⁺ (mg/l) | 220 ± 30 | 350 | Na ⁺ (%) | - | 0.562 |
| Ni ²⁺ (mg/l) | 15 ± 1 | < 0.4 | Ni ²⁺ (%) | - | 0.025 |
| Zn ²⁺ (mg/l) | 15 ± 3 | < 0.8 | Zn ²⁺ (%) | 0.0004 | 0.036 |
| S total (mg/L) | 1415 ± 80 | 100 | S total (%) | 0.149 | 0.342 |
| S sulfides (mg/L) | - | - | S sulfides (%) | 0.076 | 0.200 |
| SO ₄ ²⁻ (mg/L) | 4244 ± 239 | 300 | S sulfates (%) | 0.073 | 0.142 |

Table 2 presents the main parameters of the treated water and wastes from reactor 8D. Results showed that wastes contained a total sulphur concentration of 3240 mg/kg, which represents 1240 mg/kg more sulphur than the initial sulphur concentration, both as sulfates and as sulfides. Sulfides increased from 760 mg/kg in the fresh reactive mixture to 2000 mg/kg in generated wastes. Heavy metals were also found in the wastes. Unfortunately, metal concentrations in the fresh reactive mixture were not analyzed.

3.1 Geochemical Modeling

Results indicated that metal removal in the early stage of treatment (up to day 12) could be attributed to metal precipitation as hydroxides minerals, such as goethite (FeOOH), hematite (Fe_2O_3), magnetite (Fe_3O_4), and lepidocrocite (FeOOH) and as carbonates minerals such as otavite (CdCO_3), NiCO_3 , siderite (FeCO_3), and smithsonite (ZnCO_3).

3.2 Mineralogical Analyses

Figure 1 presents images obtained during SEM-BSE microanalysis and compositional mapping for various elements. As mentioned before, the bright spots indicate elements of high atomic weight through the mechanism of atomic number contrast. Qualitative analysis by EDS conducted on several selected bright spots helped to determine the chemical composition of the bright spots. Compositional mapping (or X-ray elemental map), very representative in the case of highly heterogeneous solids, was conducted on samples to map the distribution of selected elements (Fe, S, Ca, Mg, Si, and O). First, iron and sulphur which had accumulated in the reactive mixture of batch bioreactors was detected. Then, the study of iron and sulphur spots in relation to the weight and the atomic percentage indicated an atomic Fe/S ratio close to 2. Therefore, the bright spots turned out to be pyrite (Fe_2S). Other heavy metals removed from artificial AMD during batch treatment were not detected in the selected samples.

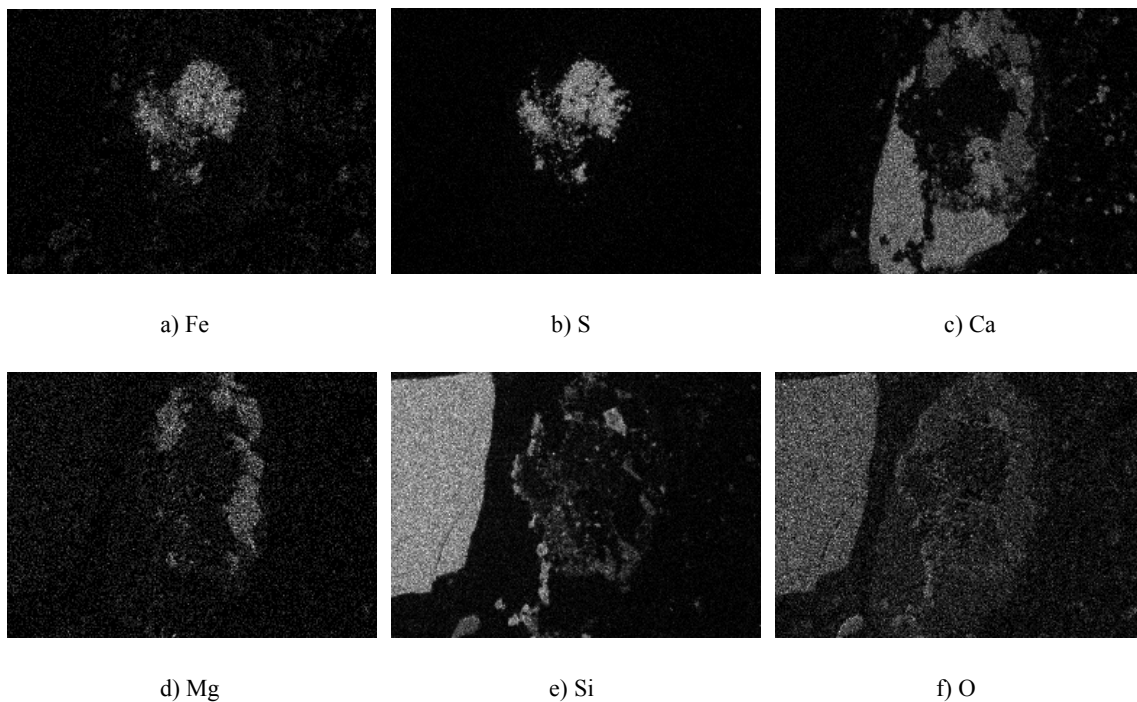
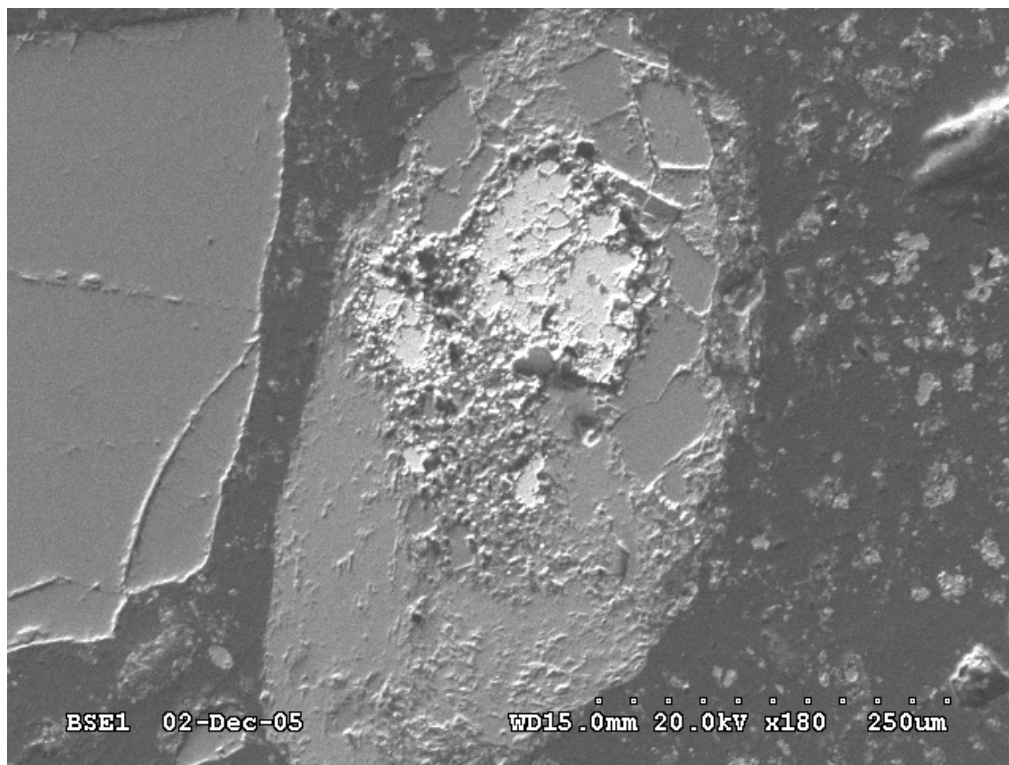

Figure 1. SEM-BSE image and compositional mapping for a) Fe; b) S; c) Ca; d) Mg; e) Si, and f) O

4. DISCUSSION

The highest content of EAS and of dissolved organic carbon and the lowest C/N ratio suggested poultry manure would be the best substrate. Unfortunately, results did not confirm this supposition. Water sampled from bioreactors 5 & 5D filled with poultry manure as a single substrate showed

quality depreciation during the first 70 days of the experiments, with increased sulfates and some heavy metal (e.g. Ni) concentrations. However, the same poultry manure which did not give good results as a single substrate worked very efficiently when integrated in a mixture. Therefore, single substrates might be less efficient than mixture of a few substrates, regardless of the amount of “easily available substances” when used in short-term experiments (Zagury et al., 2006). In long-term tests up to 350 days, one of two bioreactors filled with poultry manure showed a higher efficiency for pH neutralization and metal and sulfate removal. Nevertheless, the best performance in short-term and in long-term batch experiments was obtained with the mixture of three organic substrates, which is in concordance with results of other studies (Waybrant et al., 1998). Substrate characterization provided insight on organic carbon availability but did not elucidate their ability to promote sulphate-reduction and metal removal.

Mineralogical analyses suggested that the precipitates which formed in the media containing SRB were amorphous or poorly crystalline iron sulfides. The EDS analysis of the sulfide precipitates in solid samples from the long-term batch experiments (350 days) indicated an atomic Fe/S ratio close to 2, which was interpreted as an indication of the presence of pyrite. Chemical analysis using ICP-AES showed that the wastes contained metals removed from synthetic AMD but SEM-BSE failed to detect these metals. However, the detection limit of SEM is 0.2% which might be too high for concentrations as low as those of Mn, Cd, Ni, and Zn used in this study. Nevertheless, the presence of iron sulfides confirmed that the wastes obtained in this long-term 350 day study are more stable compared to sludge generated during AMD chemical treatment.

5. CONCLUSIONS

Passive biological treatment of synthetic AMD in batch bioreactors was successful for up to 350 days. The most effective reactive mixture for pH neutralization, metal removal, and sulfate removal contained a mixture of three organic carbon sources (maple wood chips, poultry manure, and leaf compost). Geochemical modeling of metal speciation suggested that at the beginning of the treatment (0-12 days), metals precipitated in the form of (oxy)hydroxides and carbonates. Chemical analysis of the final wastes showed higher concentrations of sulfides compared with initial concentrations found in components used for the reactive mixture preparation. Moreover, mineralogical analyses by SEM-BSE and X-ray microanalysis confirmed the presence of pyrite, a good indication of waste stability. In summary, physicochemical analyses of treated water coupled with chemical and mineralogical analyses of solid wastes are effective tools for confirming successful treatment of AMD in passive bioreactors. Further research is needed to accurately predict long-term carbon availability and to assess the metal precipitates in spent reactive mixtures.

REFERENCES

- Cocos, I.A., Zagury, G.J., Clement, B., and Samson, R. 2002. Multiple factor design for reactive mixture selection for use in reactive walls in mine drainage treatment. *Water Res.* 36, 167-177.
- Gibert, O., de Pablo, J., Cortina, J.L., and Ayora, C. 2005. Municipal compost-based mixture for acid mine drainage bioremediation: Metal retention mechanisms. *Appl. Geochem.* 20, 1648-1657.
- Gibert, O., de Pablo, J., Cortina, J.L., and Ayora, C. 2004. Chemical characterization of natural organic substrates for biological mitigation of acid mine drainage. *Water Res.* 38, 4186-4196.
- Herbert Jr., R.B., Benner, S.G., Pratt, A.R., and Blowes, D.W. 1998. Surface chemistry and morphology of poorly crystalline iron sulfides precipitated in media containing sulfate-reducing bacteria. *Chem. Geol.* 144, 87-97.
- Kuyucak, N., Chabot, F., and Martschuk, J. 2006. Successful implementation and operation of a passive treatment system in an extremely cold climate, northern Quebec, Canada. The 7th Int. Conf. on acid Rock Drainage (ICARD), March 26-30, 2006, St. Louis, MO. In: Proc. of the 7th Int. Conf. on acid Rock Drainage (ICARD), Volume 38, pp. 3131-3138. (Barnhisel, R.I., ed.). American Society of Mining and Reclamation (ASMR), Lexington, KY.
- Machemer, S.D., Reynolds, J.S., Laudon, S.L., and Wildeman, T.R. 1993. Balance of S in a constructed wetland built to treat acid mine drainage, Idaho Springs, Colorado, U.S.A. *Appl. Geochem.* 8, 587-603.

- Neculita, C.M., Zagury, G.J., and Bussiere, B. 2006. Passive treatment of acid mine drainage in bioreactors using sulphate-reducing bacteria: critical review and research needs. *J. Environ. Qual.* (in press)
- Prasad, D., Wai, M., Bérubé, P., and Henry, J.G. 1999. Evaluating substrates in the biological treatment of acid mine drainage. *Environ. Technol.* 20, 449-458.
- Reisinger, R.W., Gusek, J.J., and Richmond, T.C. 2000. Pilot-scale passive treatment test of contaminated waters at the historic Ferris-Haggarty Mine, Wyoming. The 5th Int. Conf. on Acid Rock Drainage, May 21-24, 2000, Denver, CO. In: Proc. of the 5th Int. Conf. on Acid Rock Drainage, Denver, CO, pp. 1071-1077.
- Reisman, D.J., Gusek, J.J., and Bishop, M. 2003. A pre-treatability study to provide data for construction of a demonstration bioreactor. The 10th Int. Conf. on Tailings and Mine Waste, October 12-15, 2003, Vail, CO. In: the Proc. of the 10th Int. Conf. on Tailings and Mine Waste Vail, CO., pp. 305-315.
- Song, Y. 2003. Mechanisms of lead and zinc removal from lead mine drainage in constructed wetland. Ph.D. Dissertation, Civil Engineering Department, Faculty of Graduate School, University of Missouri-Rolla, Rolla, MO.
- Tsukamoto, T.K., Killion, H.A. and Miller, G.C. 2004. Column experiments for microbiological treatment of acid mine drainage: low-temperature, low-pH and matrix investigations. *Water Res.* 38, 1405-1418.
- URS Report. 2003. Passive and semi-active treatment of acid rock drainage from metal mines-state of the practice. Prepared for U.S. Army Corps of Engineers, Concord, Massachusetts, by URS Corporation, Portland, ME. Final Draft Report, April 2003.
- Waybrant, K.R., Blowes, D.W., and Ptacek, C.J. 1998. Selection of reactive mixtures for use in permeable reactive walls for treatment of acid mine drainage. *Environ. Sci. Technol.* 32, 1972-1979.
- Zagury, G.J., Kulnieks, V., and Neculita, C.M. 2006. Characterization and reactivity assessment of organic substrates for sulfate-reducing bacteria in acid mine drainage treatment. *Chemosphere* 64, 944-954.

Chapter 2

AN OVERVIEW OF OCCURRENCE AND EVOLUTION OF ACID MINE DRAINAGE IN THE SLOVAK REPUBLIC

Andrea Slesarova¹, Maria Kusnierova¹, Alena Luptakova¹ and Josef Zeman²

¹*Institute of Geotechnics, Slovak Academy of Sciences, Watsonova 45, 04353 Kosice, Slovak Republic;* ²*Institute of Geological Sciences, Faculty of Science, Masaryk University in Brno, Kotlarska 2, 61137 Brno, Czech Republic*

Abstract: Acid mine drainage (AMD) is one of the worst environmental problems associated with mining activity. Both at the beginning and in the middle of the 20th C., the attenuation of mining activity in the Slovak Republic gave rise to the extensive closing of deposits using wet conservation i.e. flooding. The negative results of AMD activity can be observed mainly at those locations where sulphide ores and raw materials containing sulphides were mined. At the deposits in Roznava, Pezinok and Rudnany, the surrounding carbonate system partly buffers the AMD evolution. During the last decade various remediation methods were applied at the Sobov location aimed at reducing the environmental impact of AMD but without marked success. From the point of occurrence and generation of AMD, the deposits at Smolnik represent the classic example. The whole area of deposit is markedly affected by AMD activity. The mine waters have pH 3.8, high concentrations of sulphates, Fe, Mn, Cu, Zn, Al, and discharge straight into the Smolnik river. In order to propose an effective and economic method for the prevention of the negative influence of AMD at this location, it was necessary to understand the reasons for changes in the evolution of the mine water composition and provide a real estimation of their long-time evolution. The article presents the results of the monitoring of AMD quality at Smolnik from 1986 to 2005. In order to better understand the processes obtaining at the site, a geochemical modeling of AMD quality evolution during its gradual ascent to the surface was created.

Key words: Acid mine drainage; monitoring; trends; geochemical modeling.

1. INTRODUCTION

The drainage of acidic, high-mineralized mining water known as Acid Mine Drainage causes some of the most negative effects of mining activity. Acid mine drainage (AMD) is the term use to describe the drainage that occurs as a result of the natural oxidation of sulphide minerals contained in rocks when exposed to the combined action of water and atmospheric oxygen. The common sources of AMD are underground or open-pit mining works, mining waste rock or overburden dumps, processing tailings, and temporary or permanent heaps of sulphidic concentrates, notably pyrites. These sources may remain active for decades or even centuries after mine closure. Generation of AMD is observed in almost by all kinds of deposits with sulphide content. It is particularly related to coal, lignite and polymetallic sulphide mining. AMD solutions usually have a characteristic brown-red color attributed to the increased contents of Fe³⁺, and negatively impact the surrounding environment (Kontopoulos, 1998).

The main reason of AMD generation is the oxidation of sulphide minerals, especially pyrite (FeS₂). Normally, pyrite is a stable, insoluble mineral as long as it does not come into the contact with air and water. However, as a result of mining, it becomes exposed and is partially solubilized. The chemical oxidation of pyrite is expressed as (Postgase, 1959; Karavajko et al., 1972; Kontopoulos, 1998):

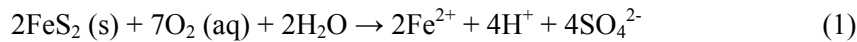

One of the important factors with regard to sulphide oxidation is the activity of bacteria. *In situ* oxidation processes of sulphides at the deposits of sulphide minerals are generally catalyzed by activity of autochthonous sulfur and iron oxidizing bacteria, e.g. *Acidithiobacillus ferrooxidans*, *Acidithiobacillus thiooxidans*, or *Leptospirillum ferrooxidans* (Kusnierova and Fecko, 2001).

Through the oxidation of pyrite or other sulphide minerals, the concentrations of Fe and elements such as Mn, Ni, Zn, Al, Cu, Co, As, Pb, etc. increase in AMD. Another result of pyrite oxidation is the increase of sulphate concentrations, which results in increasing mineralization and decreasing pH. In consequence AMD negatively affects the whole ecology of environment in the vicinity of mining plants. Where AMD is well-developed and extensive, the costs of remediation can be very high (Bethke, 1996; Younger et al., 2002).

Mining activity has in the Slovak Republic is long-standing tradition. At the beginning and in the middle of the 20th C., the attenuation of mining activity gave rise to extensive closing of deposits using wet conservation i.e. flooding. Thereby were formed the suitable conditions for generation of AMD. The negative results of AMD influence can be observed mainly at locations such as Smolnik, Sobov, Hodrusa, Pezinok, Rudnany, Roznava, Slovinky where sulphide ores and raw materials containing sulphides have been mined.

2. MATERIALS AND METHODS

Water samples for chemical analyses of anions and cations were collected and filtered with 0.45 µm cellulose membrane filters, stored in 1.5 l-polyethylene bottles and acidified down to pH < 2 with concentrate HNO₃. Field parameters such as pH, Eh and temperature of the water samples were measured *in situ*. Cations were analyzed by atomic absorption spectrometry (AAS). Anions were analyzed by ion chromatography (IC). TDS were determined by gravimetric analysis.

The Geochemist's Workbench[®] (Rockware, Inc., Golden, CO, USA) (Bethke, 1996; Bethke, 2004) was used for geochemical modeling. It is a set of interactive software tools for solving problems in aqueous geochemistry, including those encountered in environmental protection and remediation, the petroleum industry, and economic geology.

3. ACID MINE DRAINAGE IN THE SLOVAK REPUBLIC

The locations where AMD influence is very marked, or where there is a high assumption of AMD intensive generation, are as follows: Pezinok, Rudnany, Roznava, Sobov, and Smolnik (Fig. 1).

Pezinok deposit (Figure 1) is situated in Male Karpaty Mts. It is the locality with Sb-Au mineralization and main minerals: antimony, berthierite, kermisite, pyrite, arsenopyrite, quartz, and carbonates (Rojkovic, 2003). In 2004, draining mine waters had pH within the limits 4 – 6 and contained increased concentrations of Fe and sulphates (Table 1) (Grant No. 2/2106/22). Considering the polymetallic mineralization of deposit, it is assumed that oxidation of sulphidic material is constantly ongoing and probably a largely presented carbonate system buffers the generating acidity.

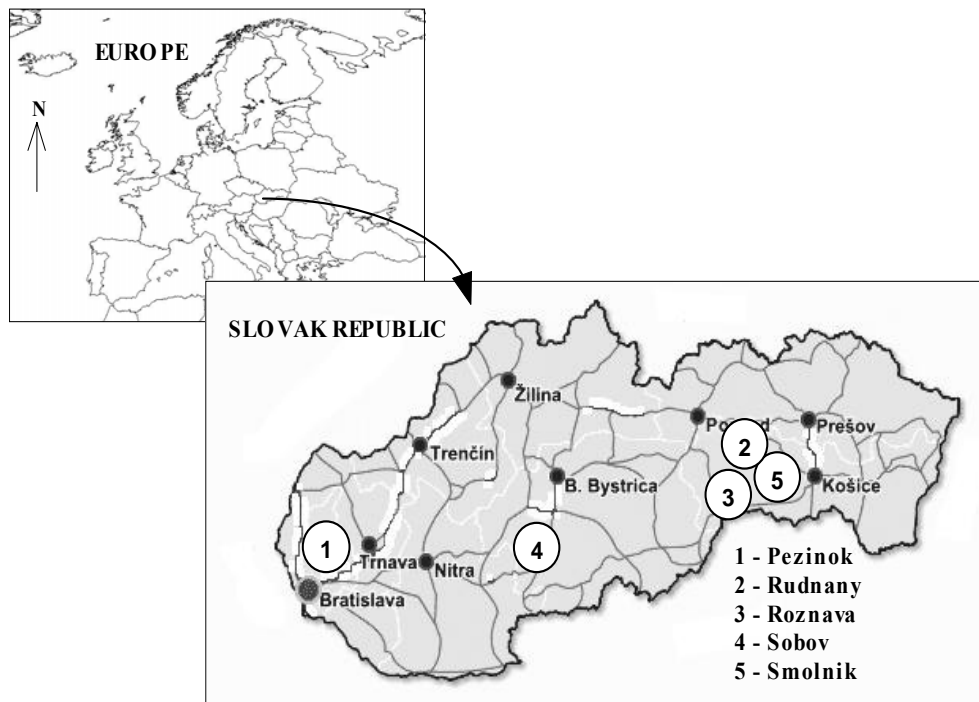

Figure 1. Map of selected deposits studied in present work.

Rudnany (Figure 1) is situated in the Ore Mountains. It is the locality with siderite-baryte mineralization and represents one of the largest accumulations of siderite having a significant share of baryte and sulphide ores (tetrahedrite, chalcopyrite, pyrite and mercury sulphide) in the Slovak Republic (Rojkovic, 2003). In 2004, an increased content of sulphates was observed. (Table 1) (Grant No. 2/2106/22). Considering the deposit mineralization, the oxidation processes of sulphides were considerably buffered through the surrounding carbonate system until now. Currently, the deposit is partially flooded. It will be interesting to observe and study the water quality in term of Fe, Hg and other heavy metals concentrations when flooding is complete.

Roznava (Figure 1) represents a significant source of AMD. It is situated in Ore Mountains. Main minerals are: siderite, quartz, pyrite, tetrahedrite, and chalcopyrite (Rojkovic, 2003). Since the beginning of 2006, significant seepages of mine waters with pH 2.8 and increased concentrations of sulphates and Fe have been observed at this location. Despite of low concentrations of the other monitored species and the neutralization capacity of carbonate system, it is obvious that the process of AMD generation is intensive (Table 1).

Sobov (Figure 1) which is situated close to the city of Banska Stiavnica, represents a much endangered area. It is a quartzite open-pit mine where pyrite occurs as unusable raw material in clay material and is then deposited at the pile. Very acidic water of deep purple color with pH 2 and high concentrations of Fe, Zn, Cu, and As drains from below the pile (Table 1) (Grant No. 2/2106/22). Draining AMD water from the open pit mine and pile is diverted into the basin from where the water is discharged into the abandoned mines. Various remediation and restoration methods, such as a pilot project of wetland systems aimed at reducing the environmental impact of AMD, were applied at the site without marked success (Sottnik and Sucha, 2001).

The influence of AMD is the most visible at the Smolnik location (Figure 1). The Smolnik deposit is one of the best known, richest Cu-Fe ore deposits in the Slovak Republic. It is situated in Ore Mountains. The main minerals of the deposit are pyrite and chalcopyrite. The original relief and surrounding area of the former mining plant is loaded with mining activity occurring over a seven hundred and thirty five year period (Rojkovic, 2003). AMD at this site contains high concentrations of sulphates, Fe, Mn, Cu, Zn, Al, and negatively affects the waters of the Smolnik stream.

Within the framework of proposals for effective and economically available methods for the prevention of negative AMD influence at the Smolnik site, it is necessary to understand the reasons for changes in the evolution of AMD composition and to provide a real estimation of their long-time evolution. A periodic monitoring of AMD quality, which provides the data for estimation of long-time evolution of AMD quality is realized. The article presents the results of the monitoring of the AMD quality at the Smolnik during the years 1986 – 2005. The geochemical modeling is used to understand processes taking place at the location in detail. It was utilized to simulate the evolution of AMD quality during its gradual ascent to the surface and the achievement of equilibrium with the atmosphere.

Table 1. Chemical characteristics of mine waters from selected Slovak localities

| Locality (year of sampling) | pH | SO ₄ ²⁻ [mg/l] | Fe [mg/l] | Cu [mg/l] | Zn [mg/l] | As [mg/l] |
|--------------------------------|------|---|--------------|--------------|--------------|--------------|
| Pezinok (2004) | 6.45 | 400 | 31.2 | <0.02 | 0.12 | 0.005 |
| Rudnany (2004) | 6.99 | 1 340 | <0.05 | <0.02 | 0.03 | <0.005 |
| Roznava (2006) | 2.8 | 940 | 66.3 | 0.44 | 0.09 | <0.005 |
| Sobov (2004) | 2.18 | - | 2 226 | 6.15 | 6.47 | 0.5 |

4. RESULTS AND DISCUSSION

4.1 Basic trends in evolution of AMD quality at the locality of Smolnik

Trends in the evolution of AMD quality at the locality of Smolnik and the evolution of concentrations of monitored AMD components are displayed in the Figure 2. In 1990, mining activity at this location was terminated. The area of deposit was gradually flooded with water from December 1990 till May 1994. The first marked changes occurred soon after the end of the flooding. In June 1994, a sudden change in the composition of draining mine waters occurred and fish kill was reported in the Smolnik stream. An intense increase in concentrations of sulphates, TDS, Fe, Mn, Cu, and Zn resulted in a massive deterioration of the ecological situation. After the rapid increase of concentrations of individual monitored species, a gradual but various decrease was observed. After the rapid increase, concentrations of Zn, Cu and Mn (Figure 2) immediately decreased. The present evolution of these components is linear. The concentrations of sulphates, TDS and Fe (Figure 3) decreased less markedly compared to concentrations of Zn, Cu and Mn. At the present time a moderate decrease of sulphates and TDS concentrations is observed. As for iron, a repeated increase of concentrations compared to 2001-2002 was followed by a recent moderate decrease.

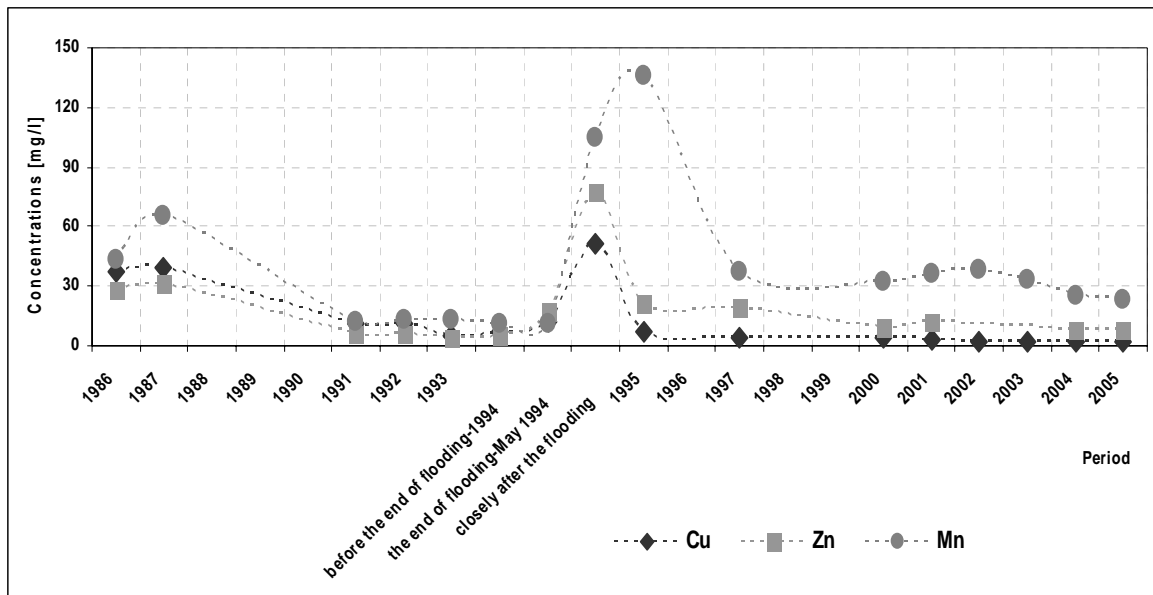

Figure 2. The evolution of Mn, Cu and Zn in AMD at the locality of Smolnik in years 1986 - 2005

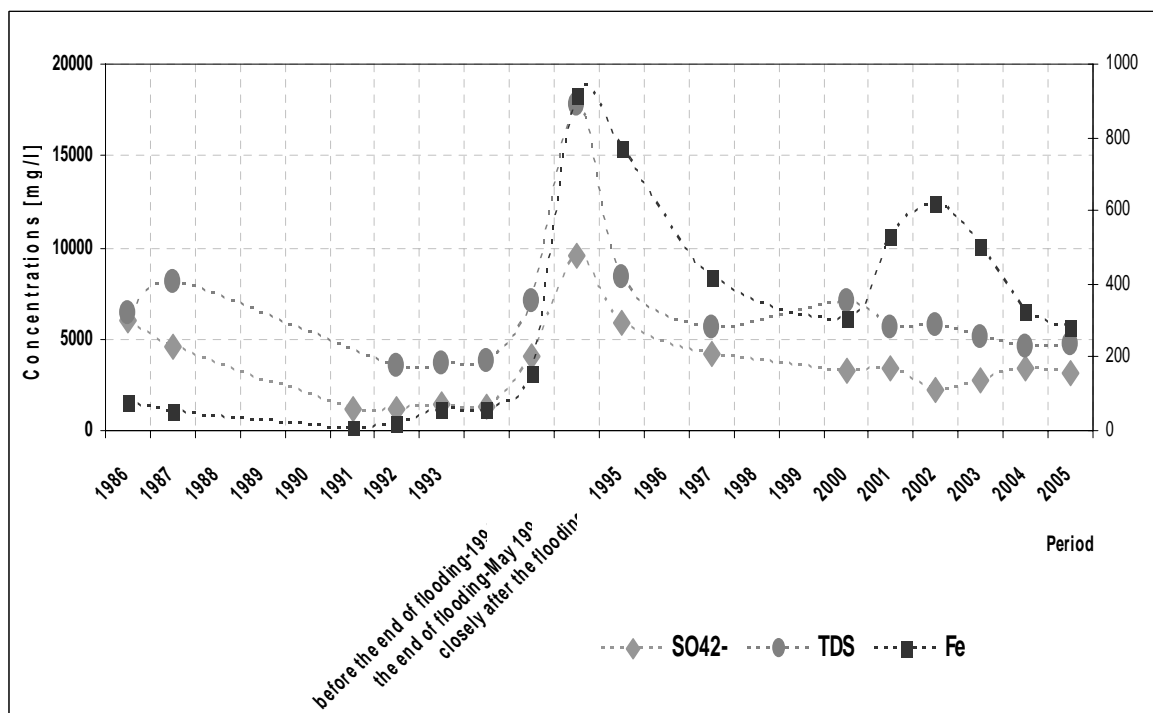

Figure 3. The evolution of sulphates (SO₄²⁻), TDS and Fe in AMD at the locality of Smolnik in years 1986 - 2005

In the case of pH, values were within the limits 2.5 – 3.2 during flooding and after the end of flooding. During the past five years the values of pH were within the limits 3.5 – 4.

On the basis of evaluation of the evolution trends of individual monitored components, it has been observed that in recent years, AMD evolution has stabilized with a moderate decrease in concentrations of individual monitored components (in the case of pH, a moderate increase of values within the limits 3.5 – 4). While this trend signals certain stability, the values of concentrations of individual monitored components from May 2006 (Table 2) hint that the situation at the site is at all the time critical.

In recent years the similar behavior of mine waters has been observed at various ore or coal deposits in the world without reference to their type and geological structure (Geller et al., 1998; Ladwig et al., 1984; Marsden et al., 1997; Zeman and Kopriva, 2002; Kopriva et al., 2004; Zeman, 2005). Adequate explanations for the reasons and mechanisms of this behavior have not been given until now.

Table 2. Chemical characteristics of AMD at the locality of Smolnik in May 2006

| Chemical composition | pH | Eh mV | SO42- [mg/l] | TDS [mg/l] | Fe [mg/l] | Cu [mg/l] | Zn [mg/l] | Al [mg/l] | Mn [mg/l] | Mg [mg/l] |
|----------------------|------|----------|-----------------|---------------|--------------|--------------|--------------|--------------|--------------|--------------|
| | 3.80 | 513 | 2 960 | 4 053 | 257 | 3.72 | 7.45 | 64.6 | 23 | 280 |

4.2 Geochemical modeling

Geochemical modeling software is being utilized ever more frequently to solve complex geochemical systems evolution, e.g. the interaction of AMD with wall rocks, migration of individual monitored components in a studied environment (Kopriva, 2002). Besides *in situ* field measurements, samples taking, their analyses, and evaluation, geochemical modeling belongs among the most effective methods of AMD-generation study. The aim of modeling is not to create the ideal model of reality but to better understand processes running within AMD and determine changes in conditions which are interesting and necessary for us to study (Zeman, 2005; Slesarova and Zeman, 2006).

On the basis of this approach, the simulation of AMD quality evolution during its gradual ascent to the surface and its achievement of entire contact with the atmosphere was realized by means of the Geochemist's Workbench[®], a geochemical modeling software. Modeling was performed with values listed in Table 3.

AMD during its ascent of surface was lead to the contact with gas phase. Gradually the increase of oxygen partial pressure to value 0.2 occurred. Simultaneously, CO₂ partial pressure decreased to value 0.0003. During this process the intense decrease of pH by hydrolysis of originating Fe³⁺ to value 3.3 (Figure 4) and precipitation of Fe compounds in form of jarosite-Na, jarosite-K, amorphous ferric hydroxide, and pyrolusite (Figure 5) should occur.

Table 3. Chemical composition of AMD used in geochemical modeling at 14°C

| Component | Concentrations | Component | Concentrations |
|-----------|----------------|-----------|----------------|
| pH | 3.9 | Li | mg/l 0.4 |
| Eh | mV 476 | Mn | mg/l 38.3 |
| TDS | mg/l 4 844 | SO42- | mg/l 2 998.9 |
| Fe2+ | mg/l 321.0 | Cl- | mg/l 21.3 |
| Ca2+ | mg/l 188.0 | F- | mg/l 2.3 |
| Mg2+ | mg/l 387.0 | HCO3- | mg/l 2.0 |
| Na+ | mg/l 4.4 | NO3- | mg/l 53.4 |
| K+ | mg/l 2.7 | SiO2 | mg/l 75.0 |

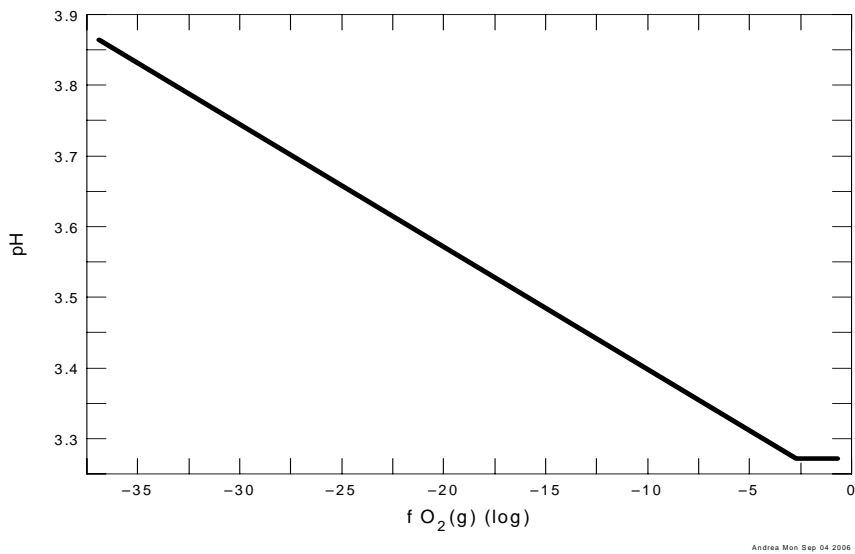

Figure 4. The change of pH during gradual mine water ascent of surface and its achievement of equilibrium with atmosphere.

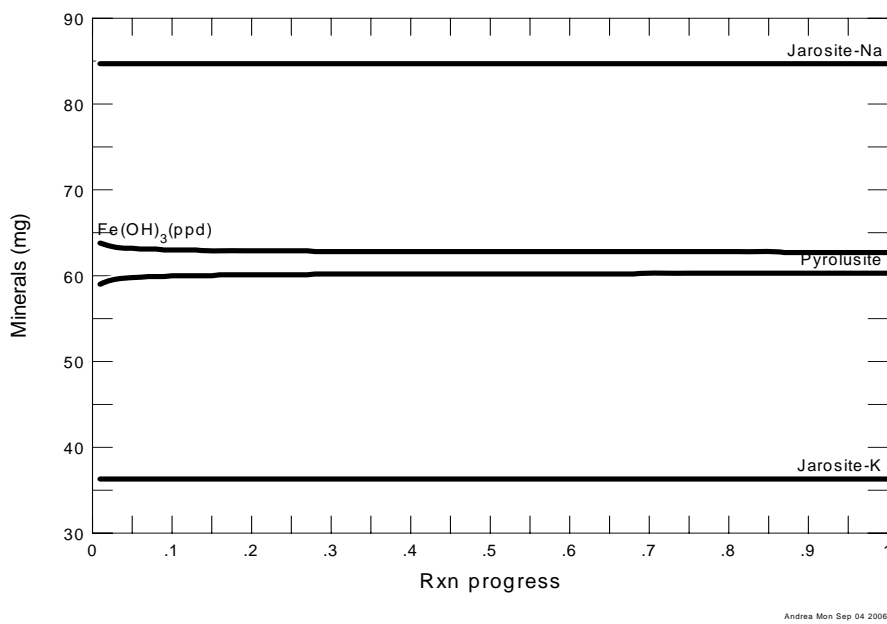

Figure 5. The precipitated minerals originated during gradual mine water ascent of surface.

The presented results of modeling are in accordance with results of analyses realized by other authors (Jasko et al., 1996; Lintnerova and Sefcikova, 2002; Lintnerova et al., 2004).

5. CONCLUSIONS

Acid mine drainage is considered one of the worst environmental problems associated with mining activity. The results of AMD activity are evident in the Slovak Republic, most markedly in the Smolnik area.

The quality of mine waters at Smolnik is always critical. But AMD quality evolution trends of individual monitored components show that in the past three years the situation is gently stabilizing particularly in the case of Cu, Zn and Mn concentrations. However, the evolution trends of pH, sulphates and TDS hint that the oxidation processes of sulphide material are running very intensively and a marked improvement of the ecological situation was not observed. The continued negative effect of mine waters on the surrounding environment is expected to continue for decades without a distinct improvement in quality.

The geochemical modeling of AMD can provide important and valuable data to understand the mechanism of natural processes taking place at Smolnik and data for engineering practice. Appropriate continuing monitoring of geochemical evolution of AMD quality, together with the utilization of modern evaluation methods and modeling tools can facilitate long-time and seasonal prediction of AMD quality evolution at Smolnik for decades. Based on those studies it will be possible to propose the effective methods of AMD remediation at Smolnik.

ACKNOWLEDGEMENT

This work was supported by the Slovak Research and Development Agency under the contract No. APVV-51-027705.

REFERENCES

- Bethke, C.M. 1996. *Geochemical Reaction Modeling*. Oxford University Press, USA, 397 pp.
- Bethke, C.M. 2004. *The Geochemist's Workbench®*, Version 5.0, a User's Guide. University of Illinois, USA, 377 pp.
- Geller, W., Klapper, H., Salomons, W. 1998. *Acidic mining lakes. Acid mine drainage, limnology and reclamation*. Springer, Heidelberg, 435 pp.
- Grant No. 2/2106/22. 2002-2004. The study of environmental biological catalysis of mine drainage acidification and mineralization in old mine biotope after exploitation of sulphidic ores. Slovak Grant Agency for Science VEGA of Ministry of Education and Slovak Academy of Sciences, Final Report, December 2004.
- Jasko, V. et al. 1996. *Smolnik – komplexne hydrogeologicke a hydrochemicke posudenie loziska Cu - Fe rud*. Final Report, Aquipur a.s. Bratislava, 125 pp.
- Karavajko, G.I., Kuznecov, S.I., Golomzik, A.I. 1972. *Rol mikroorganizmov vyscelacivanii metlov iz rud*. Nauka, Moskva.
- Kontopoulos, A. 1998. Acid mine drainage control. In: *Effluent treatment in the mining industry*, pp. 57-118. (Castro, S.H., Vegara, F., Sanchez, M.A., Eds.). University of Concepcion – Chile.
- Kopriva, A. 2002. Modelovani geochemickeho vyvoje dulnich vod po ukonceni tezby. *Geochemia 2002*, Bratislava, 75-78.
- Kopriva, A., Jez, J., Zeman, J. 2004. Sezenni a dlouhodobé trendy ve vyvoji slozeni dulnich vod. *Geochemia 2004*, Bratislava, 122-124.
- Kusnierova, M., Fecko, P. 2001. *Mineralne biotechnologie I. v tazbe a uprave sulfidickych lozisk*. VSB – TU Ostrava, 143 pp.
- Ladwig, K.J., Erickson, P.M., Kleinmann, R.L.P., Posluszny, E.T. 1984. Stratification in water quality in inundated anthracite mines, Eastern Pennsylvania. US Bureau of Mines Report of Investigations RI-8837. US Bureau of Mines, Pittsburgh, 35 pp.
- Lintnerova, O., Sefcikova, B. 2002. Zachytavanie a uvolnovanie kovov a siranov oxyhydroxidmi zeleza v sulfidickom banskom odpade. *Mineralia Slovaca*, 34, 219-232.
- Lintnerova, O., Sottnik, P., Soltes, S. 2004. Vznik kyslych banskych vod a toxickych riecnych sedimentov v okoli opustenej bane Smolnik. *Geochemia 2004*, Bratislava, 129-131.
- Marsden, M., Holloway, D., Wilbraham, D. 1997. The Position in Scotland. In: *Proceedings of the UK Environment Agency Conference on "Abandoned Mines: Problems and Solutions"*, pp. 76-84. (Bird, L., Editor). University of Sheffield.
- Postgase, J. 1959. Sulfate reduction by bacteria. *Ann. Rev. Microbiology*, 13.
- Rojkovic, I. 2003. *Ore deposits of Slovakia*. UK Bratislava, 107 pp.

- Slesarova, A., Zeman, J. 2006. The utilization of geochemical modeling in prediction of acid mine drainage evolution at the locality of Smolník (Slovak Republic). Proceedings of 10th International Conference on Environment and Mineral Processing, part I, Ostrava, 203-207.
- Sottnik, P., Sucha, V. 2001. Možnosti upravy kysleho banskeho vytoku loziska Banska Stiavnica – Sobov. *Mineralia Slovaca*, 33, 53-60.
- Younger, P.L., Banwart, S.A., Hedin, R.S. 2002. Mine Water: Hydrology, Pollution, Remediation. In: *Environmental Pollution*, Vol.5, 442 pp. (Alloway, B.J., Trevors, J.T., Eds.). Kluwer Academic Publishers, Dordrecht.
- Zeman, J. 2005. Geochemický model dulnich vod. *Geochemia 2005*, Bratislava, 113-117.
- Zeman, J., Kopriva, A. 2002. Geochemický vyvoj vod po uzavrení a zatopení dolu. *Geochemia 2002*, Bratislava, 79-83.

PART II: Analysis

Chapter 3

MASSDEP'S EVALUATION OF LABORATORY PERFORMANCE BASED ON A LARGE VOC DOUBLE-BLIND STUDY

December 13, 2005

R. Kendall Marra¹ and John J. Fitzgerald²

¹Massachusetts Department of Environmental Protection, One Winter Street, Boston, MA 02108; ²Massachusetts Department of Environmental Protection, 205B Lowell Street, Wilmington, MA 01887, <http://www.mass.gov/dep>

EXECUTIVE SUMMARY

During 2004 and 2005, the Massachusetts Department of Environmental Protection (MassDEP) conducted a large double-blind laboratory evaluation study, involving 19 commercial laboratories that provide the majority of analytical support services to parties assessing and cleaning up hazardous waste sites in Massachusetts. A double-blind study is one in which a laboratory is unaware that they have been sent samples that contain known concentrations of contaminants. The study was undertaken by MassDEP as part of a multi-year/multi-component data enhancement effort, in order to obtain a *direct, real world* sense of data quality and reliability in its waste site cleanup program.

MassDEP contracted with a well-known laboratory Proficiency Testing company to prepare test samples. To maintain the confidentiality of the study, the company set up mock consulting firms to send out samples and pay for analyses. Each laboratory was shipped a soil sample and groundwater sample spiked with measured concentrations of 5 common Volatile Organic Compounds (VOCs). This procedure was repeated on 3 different occasions -- in July, September, and November of 2004 -- at identical spiking concentrations.

In addition to these 19 commercial laboratories, double-blind samples were also delivered to the MassDEP state analytical laboratory (the Wall Experiment Station), by an agency employee, under the pretense of being samples from a confidential enforcement case.

MassDEP believes the results of this study are very encouraging. The vast majority of the laboratories evaluated were able to consistently quantify most analytes within 20% of the actual value. This excellent result is well within the most stringent acceptance criteria in use by the industry.

In a few cases, false positive or false negative results were reported, particularly with respect to vinyl chloride in water, which is known to be a problematic analyte. MassDEP is conducting further review of analytical data generated by the study to attempt to determine the reasons for these results.

Given these findings, MassDEP believes the public can have confidence in the integrity of the commercial laboratory community, and in the accuracy of the analytical data used to confirm cleanup

of sites contaminated with Volatile Organic Compounds (VOCs), which are among the most pervasive and problematic pollutants at hazardous waste sites.

1. BACKGROUND

In Massachusetts, the cleanup of contaminated sites is regulated by the Massachusetts Department of Environmental Protection (MassDEP) under a privatized program initiated in 1993. In the last 12 years, over 20,000 sites have been assessed, remediated, and closed-out under this system, by privately funded Licensed Site Professionals that are obligated to follow the performance and cleanup standards specified in 310 CMR 40.0000, the Massachusetts Contingency Plan (MCP).

Since the inception of the program, concern has existed over the quality of analytical data used to support cleanup decisions. While MassDEP has a certification program for laboratories conducting drinking water and wastewater analyses, it does not at present evaluate or certify laboratories for the analysis of soil and groundwater samples from contaminated sites. Consequently, all assessment, cleanup, and closure decisions are based upon analytical test data from laboratories that are not specifically approved or monitored for this work. Moreover, the highly competitive nature of the analytical services industry in New England led some to suspect that poor - perhaps even fraudulent - performance was common.

To address these concerns, MassDEP initiated a comprehensive *Data Quality Enhancement Program* in the late 1990s. (<http://www.mass.gov/dep/bwsc/files/data/daqdocs.htm>). With substantial input and contributions from the laboratory community, the agency generated a series of documents that provide additional detail and specification on the conduct of EPA SW-846 Test Methods, together with general sampling and analytical Quality Assurance/Quality Control requirements. While these efforts have provided guidance and additional clarity for laboratories, data users, and regulators on the production of high quality analytical data, a quantifiable and direct assessment of how well this system was working was needed.

As a result, MassDEP implemented a Double-Blind Laboratory Evaluation Program (Program) during the spring of 2004. This effort, detailed below, is believed to be one of the largest projects of its kind ever conducted in the United States.

2. OBJECTIVES

The primary objectives of this study were to improve and ensure confidence in the data relied upon by the waste site cleanup program by:

1. **Complementing and Extending the Data Quality Enhancement Program** – MassDEP has devoted considerable effort over the last five years to promote and ensure the production of reliable analytical data, producing numerous work products and policies. The overall and specific results and data from this effort will help MassDEP determine the scope and direction of future initiatives.
2. **Providing a Quantifiable Assessment of Data Quality** – While the Data Quality Enhancement Program has created the infrastructure and provided the tools for the production and documentation of high quality data, a double-blind testing effort is the most direct way to determine if these tools and procedures are being used as intended, and producing the desired results.
3. **Providing for Market Deterrence and Correction** – By design, MassDEP's privatized cleanup program reacts to market-driven incentives. Conducting and publishing the results of this and future double-blind efforts will provide a market incentive for laboratories to maintain

robust quality assurance programs, and provide a counter-balance away from competitive forces that focus only on providing the lowest-cost services.

3. SCOPE

The scope of this Program was to evaluate analytical services at 20 laboratories, including MassDEP's in-house laboratory, the Wall Experiment Station (WES). These laboratories were selected because they collectively analyze an estimated 75% of all samples related to assessment and remediation of sites in Massachusetts. The focus of the Program was on the analysis of Volatile Organic Compounds (VOCs), the most common contaminants of interest at sites across the state.

All laboratories were instructed to follow MassDEP's "MCP methods", which modify and clarify EPA's SW-846 Test Methods and replace analytical and quality control "recommendations" with "requirements", and provide detailed specification and performance standards on items that are otherwise left in SW-846 to the discretion of individual analysts. The MCP methods were developed by MassDEP in 2003 with significant input from the laboratory community, and are used at virtually all sites in Massachusetts at the present time. All laboratories that use these procedures are required to certify under pains and penalty of perjury that they have followed and have met all required procedures and standards, or, if they did not, to explicitly disclose and explain exceptions. For complete details see <http://www.mass.gov/dep/bwsc/files/data/qaqcdocs.htm>.

4. DESIGN AND EXECUTION

The design and execution of the Program involved selecting a contractor, the 20 laboratories to be evaluated, the types and concentrations of contaminants, and other sample preparation requirements.

An important feature of this study was the decision to ship 3 rounds of samples over a 4-6 month period, *containing the same analytes at the same concentrations*. In this manner, each laboratory got "3 bites at the apple". While a poor performance during a single round could be attributable to a variety of factors and circumstances - including the possibility of problems with the sample itself - consistent data outliers over multiple rounds would tend to be indicative of more systemic and/or pervasive operational and/or equipment issues at the laboratory facility.

4.1 Selection of Contractor

In accordance with state requirements, MassDEP used a competitive bidding process to select the company that would assist in conducting the program.

After receiving signed confidentiality agreements from solicited bidders, a "Request for Response" was issued in March 2004. Because complete secrecy is essential for the success of any double-blind study, the bid package placed a premium on experience performing double-blind evaluations with "third party" billing and specifically required bidders to document their experiences with laboratory coordination and confidentiality issues for similar double-blind projects.

In May 2004, the contract was awarded to Environmental Resource Associates (ERA) of Arvada, Colorado, as the most qualified Proficiency Testing (PT) provider. It is noted that ERA is the only private provider accredited by both the National Institute of Standards and Technology (NIST) and the American Association for Lab Accreditation (A2LA). Under this contract, ERA was responsible for all aspects of sample preparation, laboratory coordination, sample shipping, payment (i.e., "third party" billing) and all other administrative activities associated with the project.

4.2 Selection of Laboratories

Based upon budget and project parameters, as well as an institutional knowledge of the analytical service providers in New England, a decision was made to include 20 laboratories in the Program.

The selection of laboratories for the study was based upon the volume of work they conduct on MCP-related work in Massachusetts. Under the guise of an information gathering exercise for educational and outreach purposes, MassDEP field staff were asked to list those laboratories that, in their experience, conduct most of the analytical testing at sites within their region of the state. This list was cross-checked against a systematic examination of site cleanup reports submitted to the agency to ensure that the labs with the highest volume of samples were included. The final list of laboratories selected for inclusion in the Double-Blind study is contained in Table 1. Collectively, it is estimated that these laboratories provide analytical support services at approximately 75% of all contaminated sites in Massachusetts.

Table 1. Laboratories Selected for MassDEP Double-Blind Laboratory Evaluation Program

| Laboratory | Location |
|-----------------------------------|---------------------|
| Accutest Laboratories | Marlborough, MA |
| Alpha Analytical | Westborough, MA |
| AMRO Environmental | Merrimack, NH |
| Chemserve | Milford, NH |
| Con-Test Analytical | East Longmeadow, MA |
| Eastern Analytical | Concord, NH |
| ESS Laboratory | Cranston, RI |
| GeoLabs | Braintree, MA |
| Groundwater Analytical | Buzzards Bay, MA |
| Katahdin Analytical | Westbrook, ME |
| Maxymillian Technologies | Lanesborough, MA |
| New England Chromachem | Salem, MA |
| New England Testing | Providence, RI |
| Phoenix Environmental | Manchester, CT |
| Premier Lab | Dayville, CT |
| Spectrum Analytical | Agawam, MA |
| STL Westfield | Westfield, MA |
| Toxikon Corp. | Bedford, MA |
| Wall Experiment Station (MassDEP) | Lawrence, MA |
| Woods Hole Analytical | Raynham, MA |

4.3 Selection of Contaminants and Spiking Concentrations

Each of the three “sampling events” consisted of sending one whole-volume water sample and one whole-volume soil sample to each of the 20 laboratories. The objective was to spike common VOC contaminants in soil and/or groundwater at concentrations that should be readily identifiable and quantifiable (i.e., approximately 10 to 100 times the analyte’s Reporting Limit). An effort was made to select and spike analytes in a manner that looked realistic in order to not raise suspicions among study participants. A summary of the analytes and spiking concentrations chosen for this study, along with MassDEP risk-based cleanup standards, is shown in Table 2.

Table 2. Double-Blind Sample Analytes and Spiking Concentrations

| Water | | | Soil | | |
|---|------------------------------|---|--------------------------------------|------------------------------|--|
| Analyte | Design Target µg/L or ppb | GW-1 Standard ¹ µg/L or ppb | Analyte | Design Target µg/g or ppm | S-1/GW-1 Standard ² µg/g or ppm |
| Benzene | 25 | 5 | Benzene | 20 | 10 |
| 1,1,1-Trichloroethane (1,1,1-TCA) | 150 | 200 | 1,1,1-Trichloroethane (1,1,1-TCA) | 40 | 30 |
| Trichloroethylene (TCE) | 35 | 5 | Trichloroethylene (TCE) | 15 | 0.4 |
| cis-1,2,-Dichloroethylene (cis-1,2,-DCE) | 100 | 70 | Tetrachloroethylene (PCE) | 10 | 0.5 |
| Vinyl Chloride (VC) | 20 | 2 | Methyl-t-Butyl Ether (MtBE) | 5 | 0.3 |

¹ Applicable in drinking water resource areas² Applicable in residential settings overlying drinking water resource areas

4.4 Preparation and Shipment of Samples

Whole-volume samples were prepared by ERA using analytically verified stock standard solutions and/or neat materials. All of the stocks used in the preparation of test samples were analyzed against at least two other independent sources to ensure the accuracy of spiking concentrations. Where available, a NIST Standard Reference Material (SRM) was used as one of these sources.

All volumetric glassware used in the preparation process was calibrated to “Class A” tolerances. All balances used were calibrated and traced to NIST weights. Notes for each sample were recorded by the chemist preparing the sample and reviewed by an independent chemist or manager.

Spiking solutions were prepared in methanol. Water samples were prepared by the volumetric addition and zero headspace mixing of the spiking solution into acidified reagent water. This results in residual concentrations of methanol in the water sample (approximately 50 mg/L), which is of potential concern with respect to maintaining the confidentiality of the study (i.e., significant methanol presence in a purported “real world” sample could trigger suspicion). However, since the specified VOC testing method (MCP Method 8260B) requires laboratories to spike samples with internal and surrogate standards that are contained in a methanol solution, it was considered unlikely that the original methanol contribution would be discernable.

The preparation of soil samples was more complicated. Each evaluated laboratory provided the mock consulting company (i.e., ERA) with a pre-weighed vial containing varying amounts of methanol (5, 10, 15 or 20 ml). ERA then calculated the amount of methanol spiking solution that would need to be added to the vial to create the required target sample concentrations of indicated contaminants. A gas-tight syringe was then used to withdraw methanol from the vial, in the exact volume of the calculated spiking solution addition. Subsequently, de-ionized water was added to the vial to approximate a 5% soil moisture content, followed by the addition of the appropriate mass of dry soil (i.e., 5, 10, 15, or 20 grams). Finally, the methanol-based spiking solution was added to the methanol/water/soil mixture in the sample vial using a gas-tight syringe. The vial was then capped and shaken thoroughly to mix the contents.

In order to allow the evaluated laboratories to determine moisture content and report soil data on a “dry weight” basis, as required by MCP Method 8260B, ERA also dispensed un-spiked soil into un-preserved vials (i.e., no methanol). This soil was prepared at a moisture content of 5% by weight.

Analytes and target concentrations were not changed between rounds. However, because ERA needed to prepare a new spiking solution after the first round, there were very slight differences in some of the final spiking concentrations between Round 1 and Rounds 2 & 3.

4.5 Implementation and Follow-Through

Three mock consulting firms were created to contract analytical services with the 19 participating private laboratories. A general “script” was prepared by MassDEP for use by these “firms” concerning a desire to test a sample for an undisclosed site undergoing assessment. The most important directive given to ERA, however, was to maintain the appearance of a normal transaction, including, as appropriate, negotiating costs. All payments made to the private laboratories were from the mock consulting companies, as were all communications and correspondence.

Providing samples to the MassDEP Wall Experiment Station (WES) required a different approach. In this case, an agency employee received the shipment of samples from ERA, and personally transported them to WES under standard MassDEP Chain of Custody form and procedures. Laboratory personnel were informed that the samples originated from an undisclosed location that was the subject of a confidential agency investigation and enforcement action.

The three rounds of samples were prepared and shipped in July 2004, September 2004, and November 2004, respectively. ERA provided its final summary of results, original laboratory reports/invoices, and signed Analytical Report Certification Forms to MassDEP in April 2005.

5. RESULTS AND OBSERVATIONS

The results from this study are organized into two categories: (1) overall laboratory results, and (2) individual laboratory results. Overall results indicate laboratory performance as a whole along with general trends, observations and comparisons between compounds and matrices. Individual laboratory results are a “snapshot in time” of how a particular facility performed for these specific samples and analytical test methodologies, and may or may not be indicative of longer-term performance on other samples using similar methodologies. Individual results for each of the 20 laboratories are presented in alphabetical order in Appendix A.

5.1 Overall Laboratory Results

Overall laboratory results were compiled both numerically and graphically. The results were assessed numerically using “percent difference” expressed as the average of the absolute values of the percent differences between the “Assigned” (or “True”) Values and each of the 60 results for each compound (i.e., 20 labs and 3 rounds yield 60 results per compound per water sample and 60 results per soil sample). These results are shown in Table 3.

Table 3. Overall Laboratory Results

| Water | | | Soil | | |
|---|--------------------------------------|----------------------------|-----------------------------------|-----------------------------------|----------------------------|
| Analyte | Assigned (True) Value µg/L or ppb | Average Percent Difference | Analyte | Assigned (True) Value µg/g or ppm | Average Percent Difference |
| Benzene | 24.5 | 10.1 | Benzene | 19.8 | 24.1 |
| 1,1,1-Trichloroethane (1,1,1-TCA) | 149 | 10.8 | 1,1,1-Trichloroethane (1,1,1-TCA) | 39.9 | 25.7 |
| Trichloroethylene (TCE) | 35.2 | 8.7 | Trichloroethylene (TCE) | 15.1 | 24.4 |
| <i>cis</i> -1,2,-Dichloroethylene (<i>cis</i> -1,2,-DCE) | 101 | 15.8 | Tetrachloroethylene (PCE) | 10.2 | 24.1 |
| Vinyl Chloride (VC) | 20.4 | 33.7 | Methyl-t-Butyl Ether (MtBE) | 4.96 | 18.0 |
| Overall Average | | 15.8% | Overall Average | | 23.3% |

In addition, results were compiled in graphical form to readily assess and compare the measured values of analytes for all three rounds. These results are shown in Figures 1 through 4.

The actual numerical results for water and soil are depicted in Figures 1 and 3, respectively. However, a more useful graphical presentation is to normalize all results to the same scale to allow even comparisons between different analytes and media. Therefore, the percent differences between the assigned values and each actual lab result were calculated and are depicted in Figures 2 and 4 for water and soil, respectively.

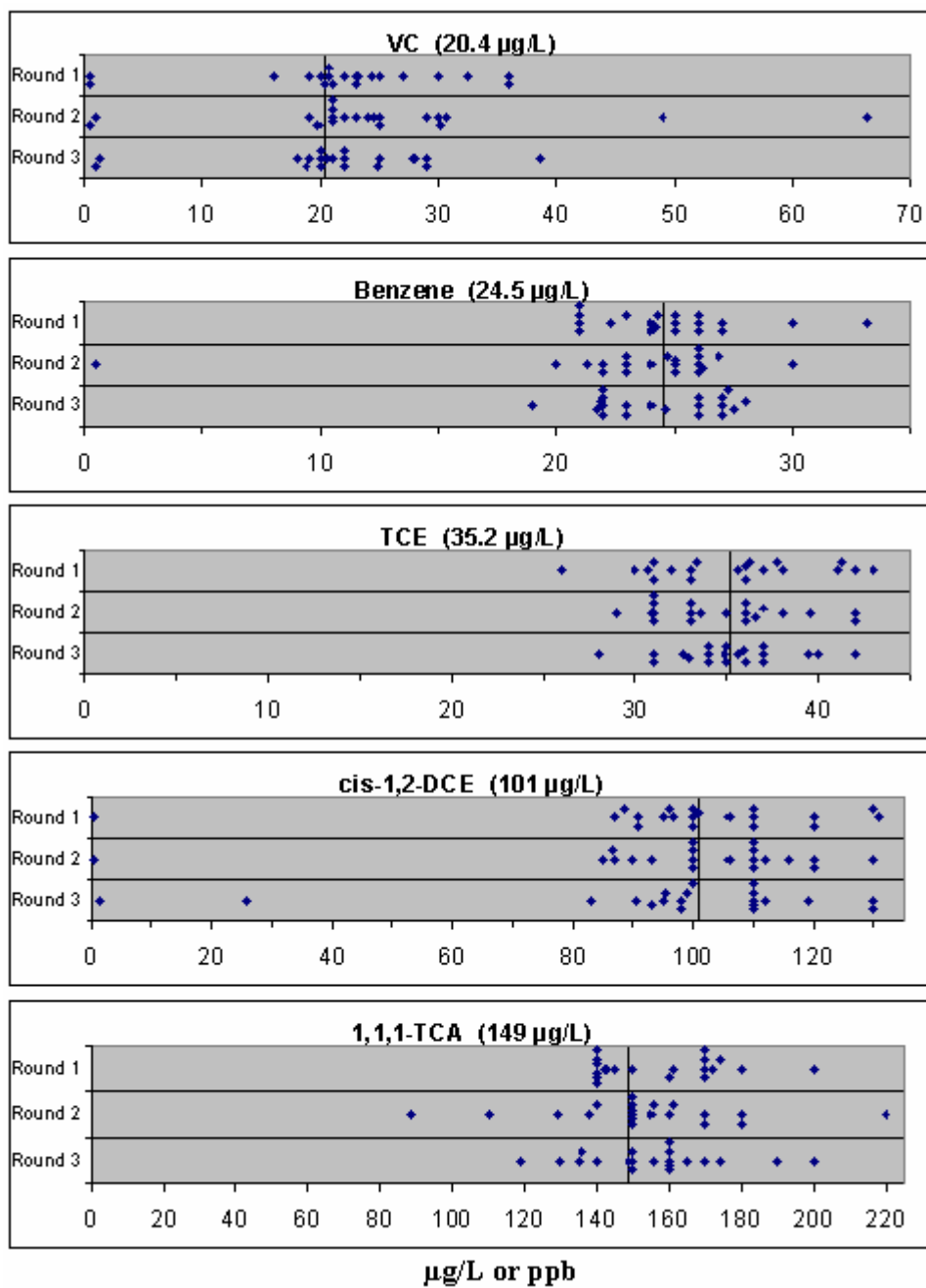

Figure 1. MassDEP Double-Blind Laboratory Evaluation Program, WATER SAMPLES, VOCs by MCP Method 8260/5030 ($\mu\text{g/L}$ or ppb)

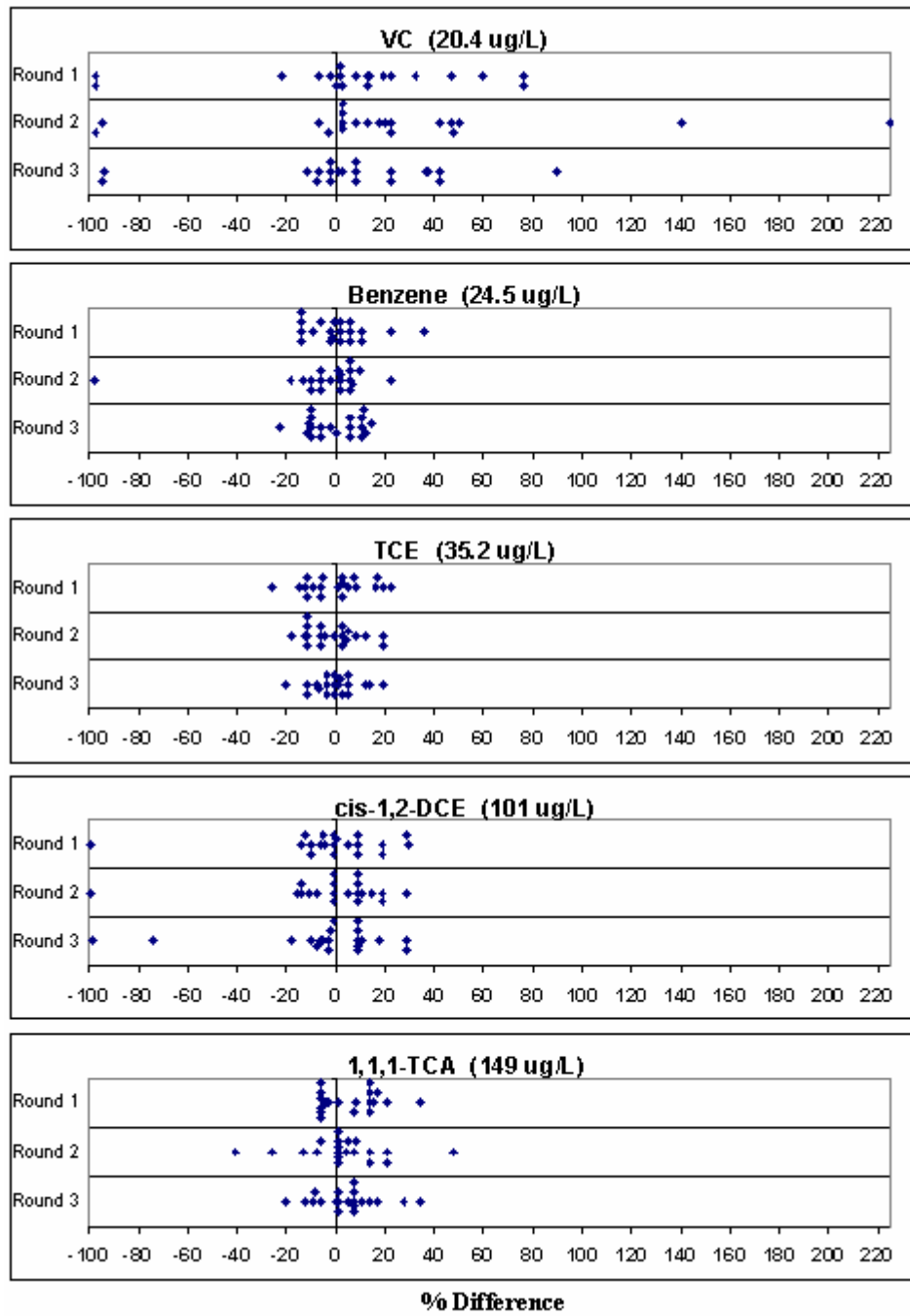

Figure 2. MassDEP Double-Blind Laboratory Evaluation Program, WATER SAMPLES, Percent Difference from Assigned Values

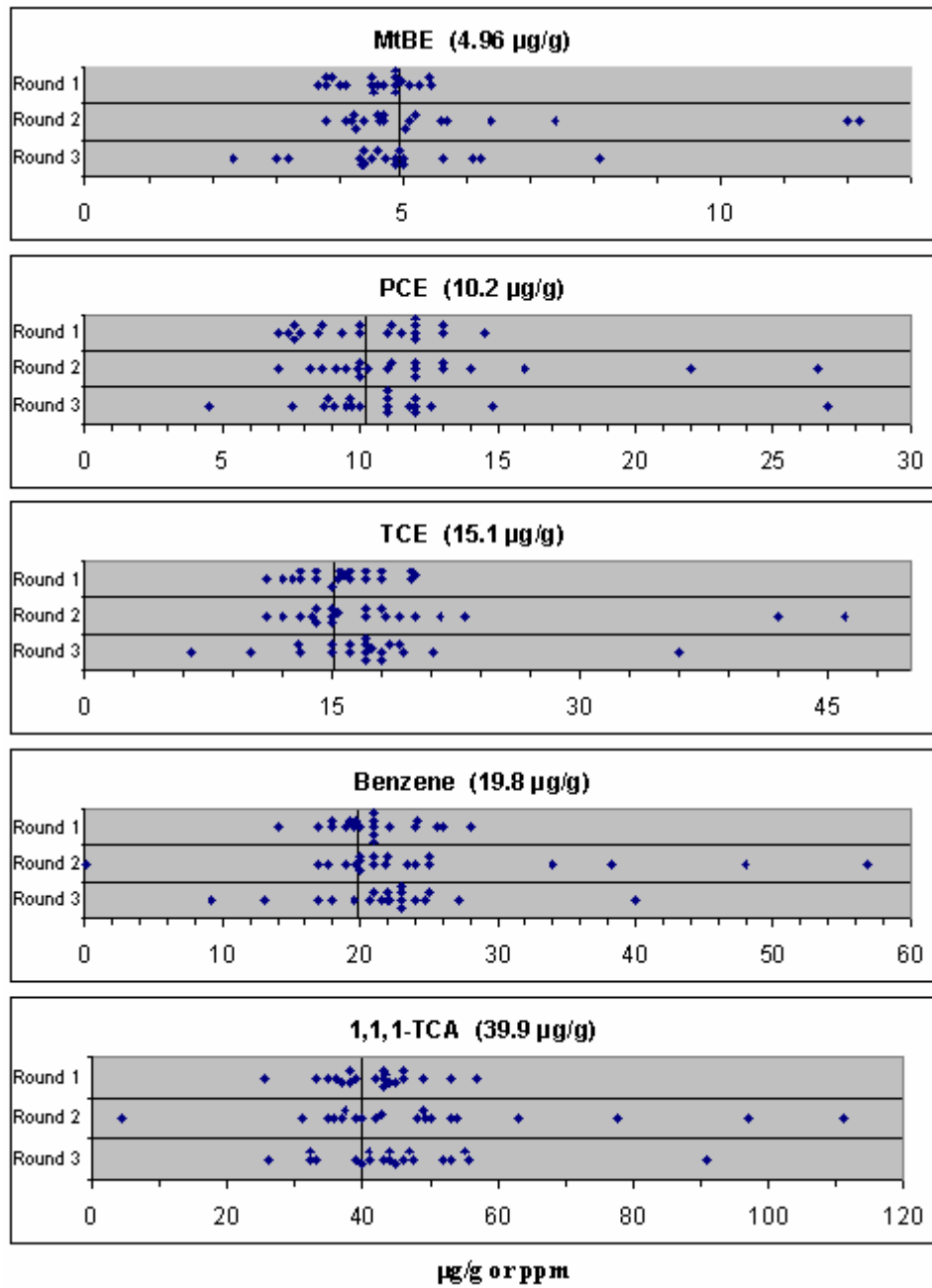

Figure 3. MassDEP Double-Blind Laboratory Evaluation Program, SOIL SAMPLES, VOCs by MCP Method 8260B/ 5035 ($\mu\text{g/g}$ or ppm)

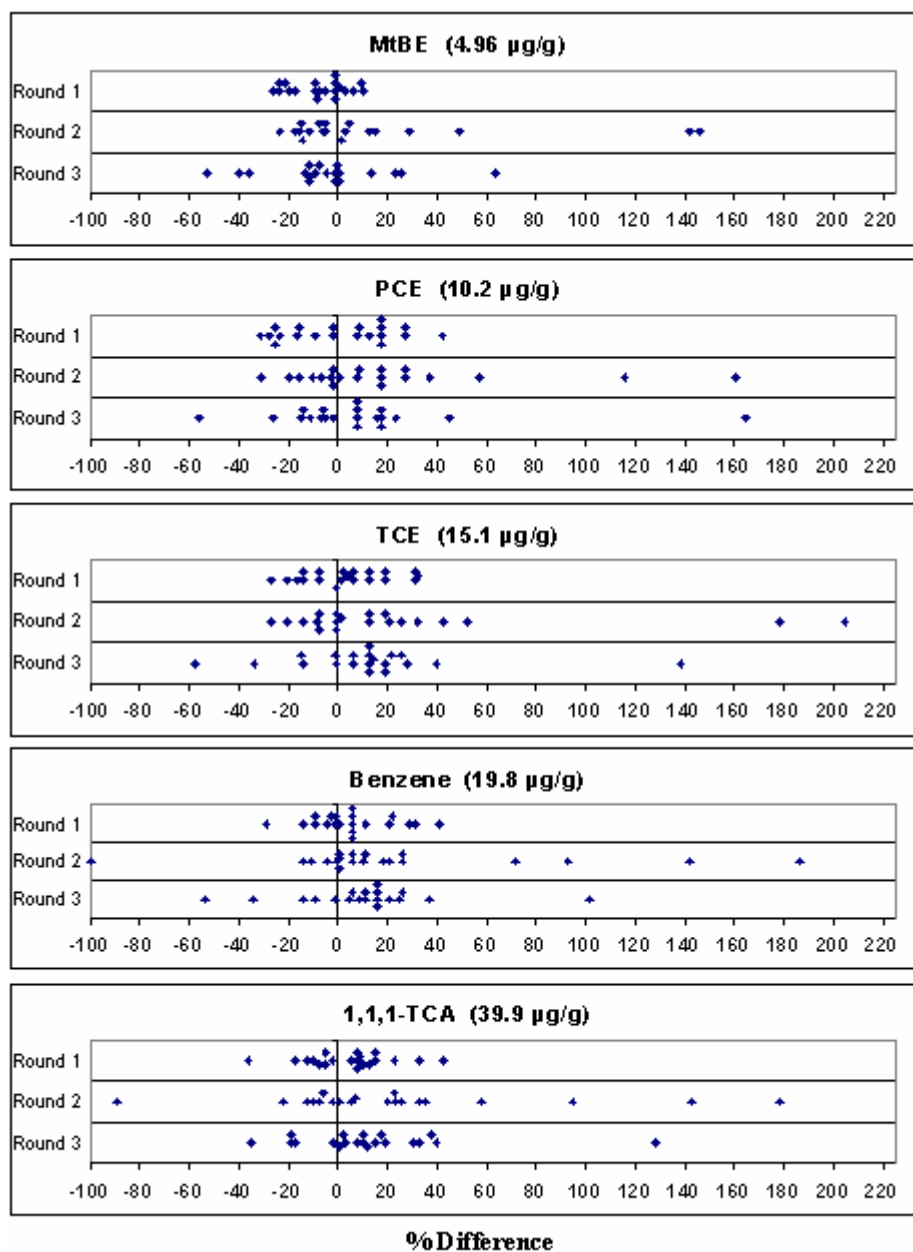

Figure 4. MassDEP Double-Blind Laboratory Evaluation Program, SOIL SAMPLES, Percent Difference from Assigned Value

5.2 Discussion of Overall Laboratory Results

Based upon these overall results and percent differences, the following findings were observed and considered by MassDEP:

5.2.1 Variability between Rounds

There was a noticeable increase in the variability of the results between the first two rounds, particularly for soil. As a whole, the overall laboratory performance was not as strong in Round 2 as it was in Round 1.

5.2.2 Accuracy of Water and Soil Matrices

The overall average differences for water and soil were 15.8% and 23.3%, respectively. With the exception of vinyl chloride (VC), all analytes in water were quantified with greater accuracy than any of the analytes in soil. Other than the VC results and with a few select but extreme exceptions, almost all of the individual laboratory results for water were within +/- 20% of the assigned (or “true”) value. Fewer, though still a majority, of the soil results were within +/- 20% of the assigned (or “true”) value.

5.2.3 Variability of Water and Soil Matrices

The overall variability (or “scatter”) of the soil results for all three rounds is greater than that for water. This was expected, given the increased complexity in the preparation and analysis of soil VOC samples, which increases the possibility (and compounding) of error and positive or negative bias, and is consistent with ERA’s historical database and other available industry information. Of methodological interest is the effect of such variables as:

- *Hold times (partitioning effects and/or methanol loss):* Hold time (the number of days between sample collection and sample analysis) is known to be an issue with real-world soil VOC samples due to (a) an increased extraction of analytes from the soil into the methanol preservative over time and/or (b) an increased possibility for methanol loss due to evaporation over time. Variability in extraction over time is unlikely to be an issue in this study since analytes were spiked directly into a methanol solution and would be unlikely to partition into the (originally uncontaminated) soil sample. Rather, for this study, loss of methanol from the sample due to evaporation could conceivably lead to a positive bias. However, when the difference for each individual soil result was plotted versus its individual hold time, no such trend is observed, and no direct correlation is evident (e.g., the maximum “R squared” number was less than 0.04). This relationship is shown graphically in Figure 5 below.

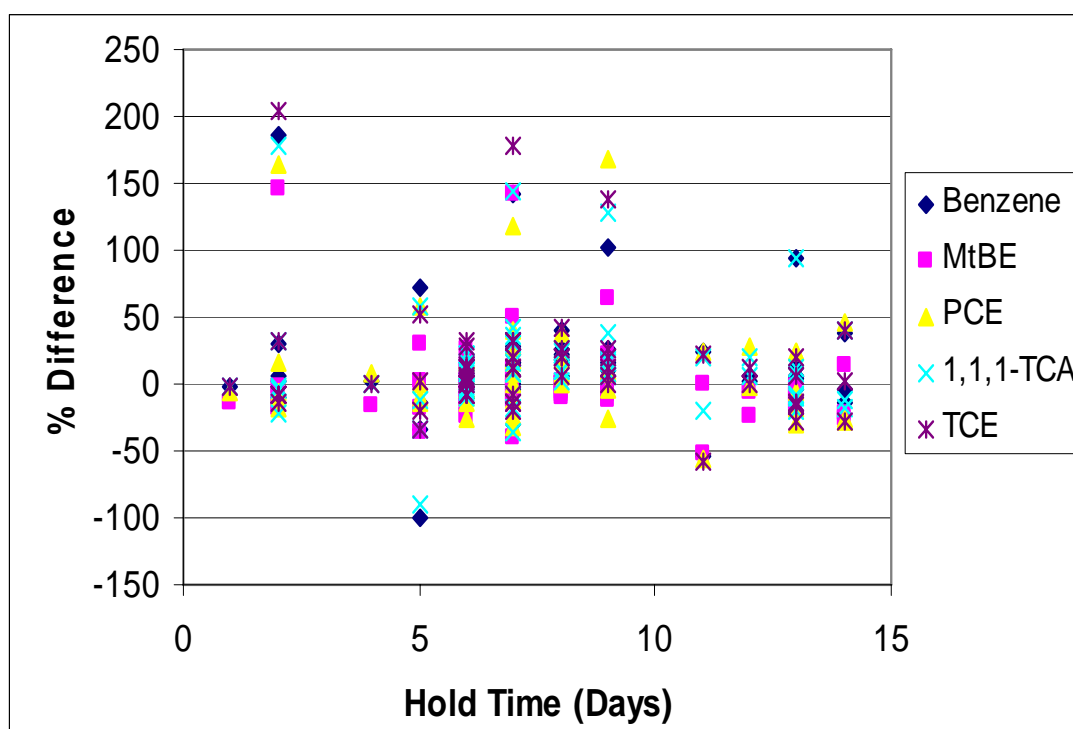

Figure 5. Percent Difference vs Hold Time (Soil)

- Methanol and sample volumes:** Smaller methanol and soil sample volumes could lead to proportionally larger analytical variability in both positive and negative directions due to measurement errors. In addition, any loss of methanol from the sample due to evaporation could be magnified in smaller samples (i.e., loss of 1 ml of methanol from a 5 gram soil/5 ml methanol sample is more significant than loss of 1 ml from a 20 gram soil/20 ml methanol sample). However, when the absolute value of difference for each individual soil result was plotted versus methanol volume, no such trend is observed, and no direct correlation is evident (e.g., the maximum "R squared" number was less than 0.02). This relationship is shown graphically in Figure 6.

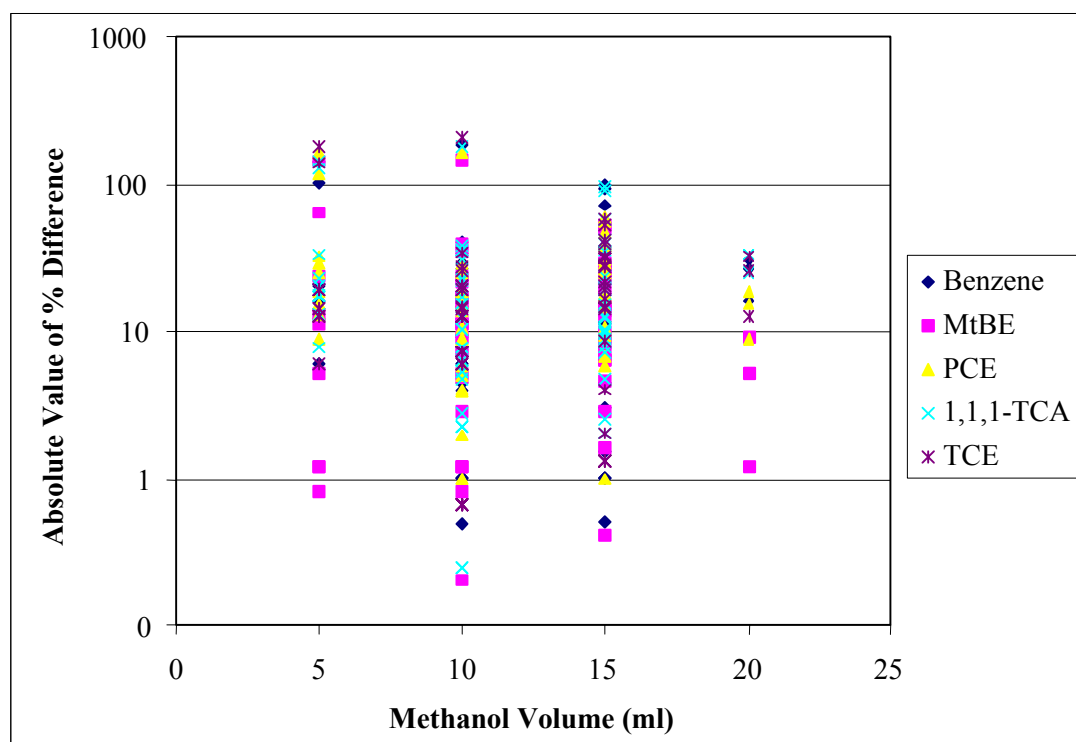

Figure 6. Percent Difference vs Methanol Volume (Soil)

- Equipment condition:** Finally, there are even more mundane explanations for the variability in soil results, including the possibility that some laboratories may analyze soil VOC samples on dedicated GC systems (separate from the instrumentation used for water samples), which tend to see more "dirty" samples, and thus may experience more systemic "carry over" and chromatographic "noise".

5.2.4 Vinyl Chloride (VC)

The average difference for VC in water was 33.7%, greater than any difference for any analyte in either water or soil. Moreover, there were six false negative (non-detect) results for VC in water. Except for these six false negatives, most of the laboratories over-quantified their VC result. Given the number of laboratories that were able to produce accurate results over all three rounds, however, it is clearly possible to adequately identify and quantify this compound, at the spiking concentration used in this study.

Because of its high volatility, some have speculated that VC results will decline over time from its true concentration (i.e., the faster the sample is analyzed, the higher the VC result will be). However, when the difference for each individual VC result in water was plotted versus its individual hold time,

no such trend is observed, and no direct correlation is evident (e.g., “R squared” was less than 0.02). This relationship is shown graphically in Figure 7.

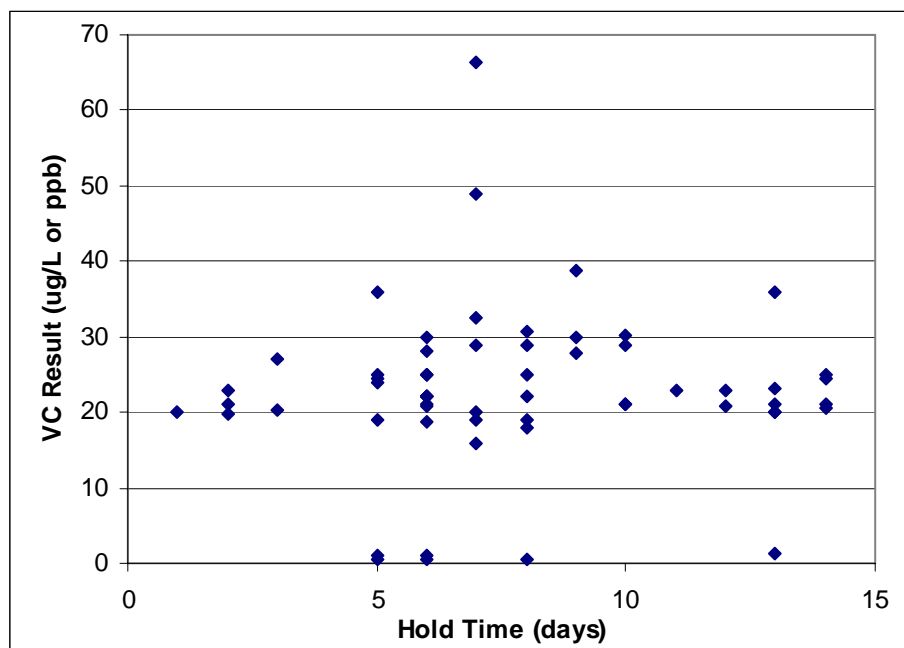

Figure 7. Vinyl Chloride Result vs Hold Time (Water), Assigned Value = 20.4 µg/L

5.2.5 False Positives

12 laboratories reported one or more false positives in the water samples and 15 laboratories reported one or more false positives in the soil samples, as detailed in Appendix A, and summarized in Figure in Figure 8.

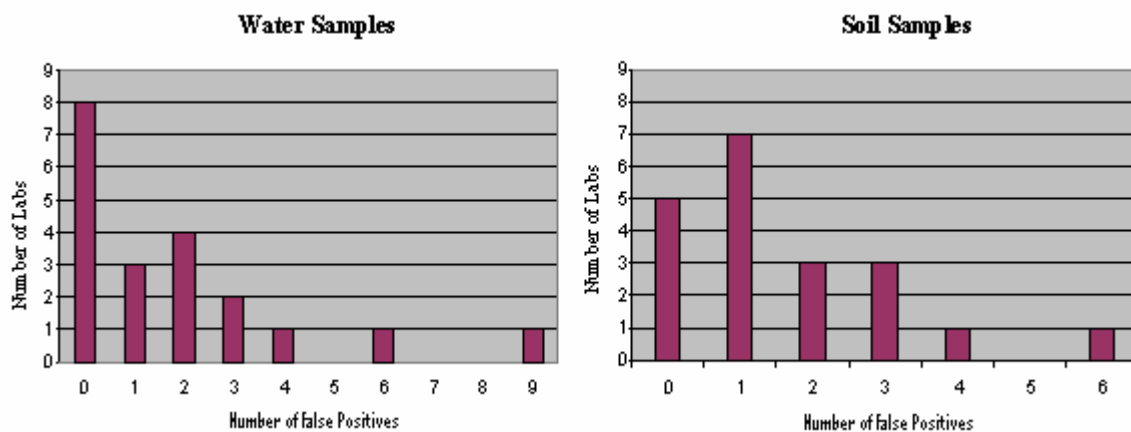

Figure 8. False Positive Detections in Water and Soil Samples (All Three Rounds)

Over all sample rounds, 11 analytes were falsely reported to be present in samples at concentrations above 1 µg/L in water and/or 1 µg/g in soil, as detailed in Table 4. Another 13 analytes were reported present at concentrations less than 1 µg/L in water and/or 1 µg/g in soil. Chloromethane was the most frequently reported false positive, with 14 detections (water samples only) at concentrations ranging to 20.7 µg/L

Table 4. False Positive Detections Above 1 µg/L Water and/or 1 µg/g Soil (All Three Rounds)

| Analyte | Water Sample Detects | | Soil Sample Detects | |
|-----------------------------|----------------------|------------------------|---------------------|-------------------------|
| | # Detects | Conc Range µg/L | # Detects | Conc Range µg/g |
| 1,1, -Dichloroethene | 5 | 3J ^a - 11 | 2 | 2 - 4.31 |
| 1,2 -Dichloroethane | | | 1 | 2.32 |
| 1,4 -Dioxane | | | 1 | 9.5 |
| Bromoform | 2 | 2.1-26 | | |
| Carbon Tetrachloride | | | 1 | 7.2 |
| Chloroethane | 1 | 12.4 | | |
| Chloromethane | 14 | 2J ^a – 20.7 | | |
| Dichlorodifluoromethane | 1 | 9.23 | | |
| Methylene Chloride | | | 2 | 1.4J ^a – 4.5 |
| Naphthalene | | | 1 | 5.5 |
| Trans-1, 2-Dichloroethylene | 1 | 2J | | |

^a “J” signifies detection below Reporting Limit

Most false positive detections were at low concentrations, and would be unlikely to significantly impact site assessment or remedial decisions. However, for most compounds, this would appear to be a preventable problem, with good laboratory practice (e.g., storing solvents and standards in locations separate from sample storage and analytical equipment areas). *The reporting of chloromethane in the aqueous samples may be an exception, in that this compound may actually be present in some samples, as a reaction/breakdown product of the acid preservative (HCl) and/or as a thermal degradation product of other analytes.* This possibility will be further pursued by MassDEP as a methodological issue of interest.

It is unclear how pervasive cross-contamination problems are within the industry. This double-blind study is perhaps instructive in this regard, given an assumption that most laboratories would likely employ especially robust “housekeeping” procedures during a single-blind study effort, knowing that they are being tested in this regard.

5.2.6 Mis-identified Compounds

Other than for VC, most of the false negatives appeared to be misidentified compounds (e.g., one lab reported *trans*-1,2-DCE at almost the exact assigned value for *cis*-1,2-DCE, and another lab reported bromoform instead of benzene).

5.2.7 Prices

The price per sample charged by the laboratories during this Program varied from \$80 to \$185, including surcharges for “MCP deliverables” billed by some of the labs. However, it is important to note that prices quoted by any one lab can vary depending on the client, the market, their marketing strategy, their volume of work and/or a number of other factors.

5.3 Individual Laboratory Results

Individual laboratory results are listed by laboratory in alphabetical order in Appendix A.

6. ACCEPTANCE LIMITS

Given the results obtained from this study, how does one go about evaluating how well laboratories performed? If 0% is the ideal percent difference, is a result of 15.8% average percent difference for water samples and 23.3% average percent difference for soil samples a good result?

Because there is no single method used by the laboratory community to rate the results of a study like this one, MassDEP compared the results of this study against 3 different types of acceptance

limits, described more fully below. Most results of the laboratories evaluated in this study met all three sets of limits, which is indeed a good result.

In determining acceptance criteria, two points must be noted. First, there are no mandated or universally applied standards to evaluate the quality of analytical testing data of this nature. Second, the difficulty of the overall task being evaluated must be considered (i.e., laboratories are attempting to identify and quantify very small amounts of chemicals, in the low parts per billion range. For perspective, note that one part per billion is equivalent to 1 inch in 16,000 miles.)

Environmental analytical data are commonly assessed using various criteria or “acceptance limits” based on a variety of state, federal, industry and/or individual laboratory standards or guidelines. These criteria can be absolute (i.e., acceptance is benchmarked to a specified value or percent difference) or relative (i.e., acceptance is based upon a statistical evaluation of multiple analyses and/or multiple laboratories). For general informational purposes, three of the most relevant approaches to the designation of acceptance limits are described below.

1) MassDEP Compendium of Analytical Methods (CAM):

The CAM is a detailed set of analytical procedures, based upon EPA SW-846 Test Methods (<http://www.mass.gov/dep/bwsc/files/data/qaqcdocs.htm>). A product of the *MassDEP Data Quality Enhancement Program*, these sets of procedures remove all ambiguities in the EPA test methods, and provide clear QA/QC performance standards and metrics.

For the test method used by laboratories during this study (i.e., MCP Method 8260B), the CAM requires the use of Laboratory Control Spikes and Surrogate Spikes to assess method accuracy. In both cases, the percent recoveries of spiked analytes must be +/- 30% of their true value. On the basis of this absolute, *intra*-laboratory assessment metric, quantification of PT sample analytes within +/- 30% of their true value, on an *inter*-laboratory basis, would be considered quite good.

2) Proficiency Test (PT) Sample Provider (ERA)

Companies that specialize in the production, distribution, and evaluation of Proficiency Test (PT) samples often establish “in-house” performance metrics. The PT provider used by MassDEP in this Program, Environmental Resource Associates (ERA), has developed and maintains its own library of methodological acceptance limits, based on years of experience in conducting studies, performance data from independent refereed laboratory studies, and data from USEPA Water Pollution (WP), Water Supply (WS), and Contract Laboratory Program (CLP) studies. ERA uses different databases for water and for soil. These limits represent approximate 95% confidence intervals based on large independent data sets (i.e., they were not calculated from the data obtained in this Program or any other *individual study*.)

3) USEPA and Industry Standard

Numerous organizations, including the USEPA and the National Environmental Laboratory Accreditation Conference (NELAC) commonly define acceptance limits on a *relative basis*, by judging a laboratory’s performance in comparison to the performance of a collective group of laboratories in a *common study*. Typically, an individual laboratory’s performance for any given PT sample analyte is considered acceptable if it is within +/- two standard deviations from the mean value reported by the collective group of laboratories. For a normal distribution, this approximately equals the 95% confidence interval (i.e., 95% of the results fall within this range).

The ranges for these three different types of acceptance limits for this Program are summarized in Tables 5 and 6 below. For illustrative purposes only, the ranges shown for the “Industry Standard”

limits are based on averages of all three rounds, rather than on separately calculated ranges for each of the three rounds. The important points, however, are that (a) the acceptance ranges from both ERA and "Industry Standard" criteria, and presumably from any other *inter*-laboratory criteria, are in some cases wider (or less conservative) than the range of +/- 30% from MassDEP CAM; and (b) most results from this Program fall within all three of these acceptance limits.

Table 5. "Acceptance Limit" Ranges for Water ($\mu\text{g/L}$ or ppb)

| Analyte | | Benzene | 1,1,1-TCA | TCE | <i>cis</i> -1,2-DCE | VC |
|--|-----------------------|-------------|-----------|-------------|---------------------|-------------|
| True Concentration ($\mu\text{g/L}$) | | 24.5 | 149 | 35.2 | 101 | 20.4 |
| Acceptable | MassDEP CAM (+/- 30%) | 17.2 - 31.9 | 104 - 194 | 24.6 - 45.8 | 70.7 - 131.3 | 14.3 - 26.5 |
| | ERA | 18.7 - 29.6 | 106 - 181 | 25.2 - 42.9 | 76.5 - 125 | 10.9 - 31.9 |
| | EPA/Industry Standard | 19.2 - 29.9 | 113 - 198 | 27.3 - 42.7 | 63.7 - 139.7 | 10.2 - 40.5 |

Table 6. "Acceptance Limit" Ranges for Soil ($\mu\text{g/g}$ or ppm)

| Analyte | | Benzene | 1,1,1-TCA | PCE | TCE | MtBE |
|-------------------------------|-----------------------|-------------|-------------|-------------|-------------|-------------|
| True Conc ($\mu\text{g/g}$) | | 19.8 | 39.9 | 10.2 | 15.1 | 4.96 |
| Acceptable | MassDEP CAM (+/- 30%) | 13.4 - 31.9 | 27.9 - 51.9 | 7.1 - 13.3 | 10.6 - 19.6 | 3.5 - 6.6 |
| | ERA | 15.5 - 24.7 | 29.9 - 50.9 | 7.20 - 13.9 | 11.5 - 19.0 | 3.34 - 6.70 |
| | EPA/Industry Standard | 9.7 - 36.3 | 16.5 - 74.8 | 3.8 - 18.8 | 5.6 - 28.9 | 2.2 - 7.8 |

A variety of other and more detailed numerical analyses may be performed on the results of this Program using the complete data summary, Individual Laboratory Results, shown in Appendix A.

7. CONCLUSIONS

On the basis of the information and data presented and discussed above, the following conclusions are offered:

- Overall laboratory performance was generally very good;
- Most results from this program fall well within all three sets of acceptance limits against which they were compared;
- MtBE recovery and quantification in soil samples was very good, with the overall lowest average percent difference (18%) of any soil analyte. This is significant, given problems that can exist with purging and with trap desorption efficiencies;
- Vinyl Chloride is a particularly problematic analyte in water samples for some laboratories, even at concentrations well above analytical Reporting Limits. This issue will be further considered and addressed as part of the agency's *Data Quality Enhancement Program*;
- False positive detections were seen to be a relatively minor - though seemingly preventable - problem. Specifically, most laboratories reported at least one analyte that was not added to the PT sample by ERA (i.e., "false positive"), presumably because of sample and/or laboratory cross-contamination issues. In all sample rounds (i.e., 60 water samples and 60 soil samples), 11 analytes were falsely reported in aqueous samples at concentrations above 1 $\mu\text{g/L}$ and/or soil samples above 1 $\mu\text{g/g}$; another 13 analytes were falsely reported at concentrations less than 1 $\mu\text{g/L}$ and/or 1 $\mu\text{g/g}$. *The reporting of chloromethane in the aqueous samples may be an exception, however, in that this compound may actually be present in some samples, as a reaction/breakdown product of the acid preservative (HCl) and/or as a thermal degradation product of other analytes.* This possibility will be further pursued by MassDEP as a methodological issue of interest; and
- This was a useful exercise, affirming the feasibility and utility of a state agency to engage in what many agree is the next horizon in analytical quality assurance/quality control: large-scale, systematic double-blind testing programs. In addition to providing useful

information on specific technical and operational matters, such studies also serve as a powerful market incentive to promote better work, to the extent they become a regular and expected occurrence. MassDEP intends to leverage these forces and conduct similar programs in the future.

REFERENCES

- Environmental Resource Associates, 2005, Environmental Proficiency Testing and Quality Control Standards, Environmental Resource Associates, Arvada, Colorado.
- Massachusetts Department of Environmental Protection, December 13, 2005, MassDEP Report on Results of the 2004-2005 Double-Blind Laboratory Evaluation Program; <http://www.mass.gov/dep/cleanup/dbl-blnd.pdf>.
- Massachusetts Department of Environmental Protection, 2003 and as amended, Massachusetts Contingency Plan, 310 CMR 40.0000; <http://www.mass.gov/dep/bwsc/files/mcp/310cmr40.pdf>.
- Massachusetts Department of Environmental Protection, 2003; Compendium of Quality Assurance and Quality Control Requirements and Performance Standards for Selected Analytical Methods; <http://www.mass.gov/dep/bwsc/files/data/qaqcdocs.htm>.
- U.S. Environmental Protection Agency; June, 2003, 2003 NELAC Standard; EPA/600/R-04/003; National Environmental Laboratory Accreditation Conference; June, 2003.
- U.S. Environmental Protection Agency, December 30, 1998, National Standards for Water Proficiency Testing Studies; NERL-Ci-0045.

APPENDIX A: INDIVIDUAL LABORATORY RESULTS

Table 7. Individual Laboratory Results, Round #1 WATER (µg/L or ppb)

| | Analytes | | | | | Analytes reported as false positives | | | | | |
|--------------------------------------|---------------------|------------------------|-----------------------|-------------------|---------------|--------------------------------------|---------------|-------------------------|----------------------------|--------------------|------------|
| | Benzene | cis-1,2-Dichloroethane | 1,1,1-Trichloroethane | Trichloroethylene | Vinylchlorine | Chloroethane | Chloromethane | Dichlorodifluoromethane | Trans-1,2-Dichloroethylene | 1,1-Dichloroethene | Chloroform |
| Assigned Values | 24.5 | 101 | 149 | 35.2 | 20.4 | | | | | | |
| Participating Labs | Units = µg/L | | | | | | | | | | |
| Accutest Laboratories | 25.0 | 101 | 172 | 37.7 | 23.2 | | | | | 3.7 | |
| Alpha Analytical | 21 | 96 | 150 | 31 | 36 | | | | | | |
| AMRO Environmental | 25 | 110 | 160 | 37 | 27 | | 3.8 | | | | |
| Chemserve | 23 | 100 | 140 | 26 | 19 | | | | | | |
| Con-Test Analytical | 24.2 | 96.8 | 143 | 36.2 | 20.8 | | | | | | |
| Eastern Analytical | 27 | 120 | 170 | 36 | 30 | | | | | | |
| ESS Laboratory | 21 | 88.6 | 145 | 30.7 | 20.4 | | | | | | |
| GeoLabs | 33.2 | 87.0 | 142 | 41.2 | 20.7 | | 20.7 | 9.23 | | | |
| Groundwater Analytical | 24 | 100 | 170 | 33 | 23 | | | | | | |
| Katahdin Analytical | 26 | 110 | 140 | 32 | 20 | | | | 2J | 3J | 0.5J |
| Maxmillian Technologies | 24.3 | ND (1.0) | 140 | 35.6 | 24.4 | 12.4 | | | 103 | | |
| New England Chromachem | 30 | 131 | 174 | 43 | ND (1.0) | | | | | | |
| New England Testing | 26 | 110 | 170 | 38 | ND (1.0) | | | | | | |
| Phoenix Environmental | 24 | 95 | 140 | 33 | 23 | | | | | | |
| Premier Lab | 21 | 91 | 140 | 31 | 21 | | | | | | |
| Spectrum Analytical | 22.3 | 106 | 161 | 33.4 | 32.5 | | 4.4 | | | | |
| STL Westfield | 21 | 91 | 140 | 30 | 16 | | | | | | |
| Toxikon Corp. | 27 | 130 | 200 | 42 | 36 | | | | | | |
| Wall Experiment Station ¹ | 25 | 120 | 170 | 36 | 22 | | | | | | |
| Woods Hole Analytical | 26 | 100 | 180 | 41 | 25 | | | | | | |
| Study Mean | 24.8 | 104 | 157 | 35.2 | 24.4 | | | | | | |
| Standard Deviation | 3.1 | 13 | 17.7 | 4.5 | 5.7 | | | | | | |

¹All Wall Experimental Station Results flagged with 'B'; by Laboratory. B= Analyte detected in LB, LRB, and/or no trip blank was collected.

Table 8. Individual Laboratory Results, Round #1 SOIL (µg/g or ppm)

| | Analytes Spiked | | | | | | Analytes reported as false positives | | | | | | | |
|--------------------------------------|-----------------|-----------------------------|-------------|---------------------|-----------------------|-------------------|--------------------------------------|---------------------------|---------------------|--------------------------|-------------------------|-----------------------|--------------------|---------------------------|
| | % Solids | Benzene | MTBE | Tetrachloroethylene | 1,1,1-Trichloroethane | Trichloroethylene | <i>1,4-Dioxane</i> | <i>1,1-Dichloroethene</i> | <i>Bromomethane</i> | <i>tert-Butylbenzene</i> | <i>sec-Butylbenzene</i> | <i>n-Butylbenzene</i> | <i>Naphthalene</i> | <i>Methylene chloride</i> |
| Assigned Values | 95.0% | 19.9 | 4.96 | 10.4 | 39.9 | 15.1 | | | | | | | | |
| Participating Labs | % | Units =mg/Kg dry wt. | | | | | | | | | | | | |
| Accutest Laboratories | 91.1 | 14.1 | 4.97 | 7.82 | 25.5 | 12.0 | | 0.320 | | | | | | |
| Alpha Analytical | 95 | 19 | 4 | 8.5 | 36 | 13 | | | | | | | | |
| AMRO Environmental | 95.0 | 26.0 | 4.90 | 12.0 | 53.0 | 20.0 | | 0.920 | | | | | | |
| Chemserve | 94.2 | 21 | 4.9 | 7 | 43 | 13 | 9.5 | | | | | | | |
| Con-Test Analytical | 94.8 | 22.1 | 4.54 | 8.62 | 43.0 | 12.6 | | 4.31 | | | | | | |
| Eastern Analytical | 95 | 24 | 4.9 | 12 | 49 | 16 | | | | | | | | |
| ESS Laboratory | 96 | 19.7 | 3.79 | 11.1 | 43.5 | 15.4 | | | | | | | | |
| GeoLabs | 95 | 24.2 | 5.41 | 11.5 | 46 | 19.8 | | | | | | | | |
| Groundwater Analytical | 94 | 21 | 4.9 | 13 | 37 | 16 | | | | | | | | |
| Katahdin Analytical | 94.3 | 17.0 | 3.9J | 7.4 | 33.0 | 11.0 | | 0.490J | | | | | | 1.40JB |
| Maxmillian Technologies | 94.1 | 19.3 | 3.67 | 7.62 | 34.9 | 15.3 | | | 0.163 | 0.059 | 0.059 | 0.084 | 0.658 | |
| New England Chromachem | 81 | 19.6 | 5.27 | 7.62 | 38 | 15.7 | | | | | | | | |
| New England Testing ¹ | 95.13 | 28.0 | 4.50 | 11.0 | 44.0 | 18.0 | | | | | | | | |
| Phoenix Environmental | 94 | 20.0 | 5.10 | 12.0 | 46.0 | 17.0 | | | | | | | | |
| Premier Lab | 94.8 | 18.0 | 3.80 | 10.0 | 39.0 | 14.0 | | | | | | | | |
| Spectrum Analytical | 94.9 | 25.6 | 5.46 | 14.5 | 56.8 | 19.8 | | | | | | | | |
| STL Westfield | 94.7 | 21.0 | 4.50 | 12.0 | 43.0 | 17.0 | | | | | | | | |
| Toxikon Corp. | 94.2 | 18.0 | 4.10 | 9.30 | 38.0 | 14.0 | | | | | | | | |
| Wall Experiment Station ² | 94 | 21 | 4.6 | 10 | 42 | 15 | | | | | | | | |
| Woods Hole Analytical | 94.5 | 21 | 4.7 | 13 | 45 | 18 | | | | | | | | |
| Study Mean | 93.8 | 21.0 | 4.63 | 10.3 | 41.8 | 15.6 | | | | | | | | |
| Standard Deviation | 3.2 | 3.3 | 0.55 | 2.2 | 7.0 | 2.6 | | | | | | | | |

¹Katahdin Analytical and New England Testing data for 1,1,1-TCA, Benzene, TCE, and PCE taken from diluted runs, 'E' flagged on original run.

²All Wall Experimental Station results flagged with 'B' by Laboratory. B= Analyte detected in LB, LRB, and/or no trip blank collected.

Table 9. Individual Laboratory Results, Round #2 WATER (µg/L or ppb)

| | Analytes Spiked | | | | | Analytes reported as false positives | | | | | | |
|---------------------------|---------------------|------------------------|-----------------------|-------------------|---------------|--------------------------------------|---------------|-------------------------|----------------------------|--------------------|-----------|------------|
| | Benzene | cis-1,2-Dichloroethane | 1,1,1-Trichloroethane | Trichloroethylene | Vinylchlorine | Chloroethane | Chloromethane | Dichlorodifluoromethane | trans-1,2-Dichloroethylene | 1,1-Dichloroethene | Bromoform | Chloroform |
| Assigned Values | 24.5 | 101 | 149 | 35.2 | 20.4 | | | | | | | |
| Participating Labs | Units = µg/L | | | | | | | | | | | |
| Accutest Laboratories | 21.3 | 93.1 | 138 | 30.9 | 21.0 | | | | | 6.3 | | |
| Alpha Analytical | 24 | 100 | 160 | 36 | 21 | | | | | | | |
| AMRO Environmental | 20 | 87 | 150 | 29 | 22 | | | | | | | |
| Chemserve | 26 | 110 | 180 | 33 | 30 | | 4 | | | | | |
| Con-Test Analytical | 26.2 | 116 | 88.5 | 33.0 | 30.2 | | | | | | | |
| Eastern Analytical | 30 | 130 | 220 | 42 | 49 | | | | | | | |
| ESS Laboratory | 26.9 | 106 | 156 | 39.5 | 24.5 | | | | | | | |
| GeoLabs | 23.0 | 86.5 | 129 | 33.6 | 19.8 | | | | | | | |
| Groundwater Analytical | 22 | 100 | 140 | 31 | 21 | | | | | 11 | | |
| Katahdin Analytical | 26 | 120 | 180 | 42 | 29 | | | | 0.4J | 3J | | 0.6J |
| Maxmillian Technologies | 25.0 | ND (1.0) | 150 | 36.0 | 30.7 | | 2.04 | | 106 | | | |
| New England Chromachem | ND (1) | 112 | 161 | 37 | 25 | | | | | | 26 | |
| New England Testing | 25 | 110 | 170 | 31 | ND (1.0) | | | | | | | |
| Phoenix Environmental | 23 | 100 | 150 | 31 | 21 | | | | | | | |
| Premier Lab | 26 | 100 | 150 | 35 | 24 | | | | | | | |
| Spectrum Analytical | 24.7 | 110 | 155 | 36.6 | 66.3 | | | | | | | |
| STL Westfield | 22 | 85 | 110 | 31 | 19 | | 1.0 | | | | | |
| Toxikon Corp. | 26 | 110 | 170 | 38 | 25 | | | | | | | |
| Wall Experiment Station | 25 | 120 | 150 | 36 | 23 | | | | | | | |
| Woods Hole Analytical | 23 | 90 | 150 | 33 | ND (2.0) | | 3.1 | | 2.2 | | 21 | |
| Study Mean | 24.5 | 105 | 153 | 34.7 | 27.9 | | | | | | | |
| Standard Deviation | 2.3 | 13 | 26.8 | 3.7 | 11.8 | | | | | | | |

Table 11. Individual Laboratory Results, Round #3 WATER (µg/L or ppb)

| | Analytes Spiked | | | | | Analytes reported as false positives | | | | | | |
|---------------------------|---------------------|------------------------|-----------------------|-------------------|---------------|--------------------------------------|---------------|-------------------------|----------------------------|--------------------|-----------|------------|
| | Benzene | cis-1,2-Dichloroethane | 1,1,1-Trichloroethane | Trichloroethylene | Vinylchlorine | Chloroethane | Chloromethane | Dichlorodifluoromethane | trans-1,2-Dichloroethylene | 1,1-Dichloroethene | Bromoform | Chloroform |
| Assigned Values | 24.5 | 101 | 149 | 35.2 | 20.4 | | | | | | | |
| Participating Labs | Units = µg/L | | | | | | | | | | | |
| Accutest Laboratories | 27.5 | 112 | 174 | 35.6 | 38.7 | | | | | | | |
| Alpha Analytical | 19 | 83 | 130 | 28 | 20 | | | | | | | |
| AMRO Environmental | 23 | 98 | 160 | 34 | 21 | | 3.6 | | | | | |
| Chemserve | 26 | 110 | 150 | 35 | 20 | | 3 | | | | | |
| Con-Test Analytical | 27.3 | 90.6 | 135 | 39.4 | 27.9 | | 3.9 | | | | | |
| Eastern Analytical | 26 | 110 | 160 | 35 | 29 | | | | | | | |
| ESS Laboratory | 23.0 | 93.2 | 149 | 32.9 | 20 | | | | | | | |
| GeoLabs | 21.7 | 25.7 | 119 | 35.9 | 18.8 | | 6.40 | | | | | |
| Groundwater Analytical | 22 | 100 | 170 | 31 | <2.5 | | | | | | | |
| Katahdin Analytical | 27 | 130 | 190 | 37 | 29 | | 2J | | 0.5J | | | 0.8J |
| Maxmillian Technologies | 24.6 | 1.54 | 156 | 34.9 | 24.9 | | 4.11 | | 101 | | | |
| New England Chromachem | 28 | 119 | 165 | 40 | 22 | | | | | | | |
| New England Testing | 22 | 95 | 160 | 34 | 19 | | | | | | | |
| Phoenix Environmental | 27 | 110 | 160 | 37 | 28 | | | | | | | |
| Premier Lab | 26 | 110 | 150 | 36 | 22 | | | | | | | |
| Spectrum Analytical | 21.9 | 95.4 | 136 | 32.6 | 20.6 | | 2.3 | | 1 | | | |
| STL Westfield | 22 | 99 | 140 | 31 | 18 | | | | | | | |
| Toxikon Corp. | 27 | 130 | 200 | 42 | 25 | | | | | | | |
| Wall Experiment Station | 22 | 110 | 150 | 34 | 22 | | | | | | | |
| Woods Hole Analytical | 24 | 98 | 160 | 37 | <2 | | 3.0 | | | | | |
| Study Mean | 24.4 | 96 | 156 | 35.1 | 23.7 | | | | | | | |
| Standard Deviation | 2.6 | 31 | 19.3 | 3.3 | 5.2 | | | | | | | |

¹All Wall Experimental Station results flagged with 'B' by Laboratory. B= Analyte detected in LB, LRB, and/or no trip blank collected.

Table 12. Individual Laboratory Results, Round #3 SOIL (µg/g or ppm)

| | Analytes Spiked | | | | | | Analytes reported as false positives | | | | |
|--------------------------------------|-----------------|-------------|-------------|---------------------|-----------------------|-------------------|--------------------------------------|--------------------|--------------------|--------------------|--------------------|
| | % Solids | Benzene | MTBE | Tetrachloroethylene | 1,1,1-Trichloroethane | Trichloroethylene | <i>tert</i> amyl ether | 1,1-Dichloroethane | 1,2-Dichloroethane | <i>m,p</i> -Xylene | Methylene chloride |
| Assigned Values | 95.0% | 19.8 | 4.96 | 10.1 | 39.9 | 15.1 | | | | | |
| Participating Labs | % | | | | | | | | | | |
| Accutest Laboratories | 95.6 | 20.7 | 4.37 | 9.59 | 32.3 | 12.9 | | 0.517 | 2.32 | | |
| Alpha Analytical | 95 | 24 | 4.6 | 10 | 44 | 18 | | | | | |
| AMRO Environmental | 95.4 | 23 | 4.5 | 11 | 53 | 17 | | 0.63 | | 0.034 | |
| Chemserve | 95.1 | 17 | 4.4 | 8.8 | 33 | 13 | | | | | |
| Con-Test Analytical | 95.3 | 9.22 | 2.34 | 4.52 | 32.3 | 6.38 | | 2.95 | | | |
| Eastern Analytical | 96 | 23.0 | 5.00 | 11.0 | 47.0 | 17.0 | | | | | |
| ESS Laboratory | 94 | 19.6 | 4.31 | 9.51 | 39.1 | 14.9 | | 0.0568 | | | |
| GeoLabs | 96 | 22.1 | 4.73 | 11.8 | 40.9 | 19.3 | | | | | |
| Groundwater Analytical | 95 | 25.0 | 6.1 | 11.0 | 55.0 | 19.0 | | | | | |
| Katahdin Analytical ¹ | 95.1 | 22.0 | 4.4 | 7.5 | 46.0 | 16.0 | | | | | 0.24J |
| Maxmillian Technologies | 95.4 | 27.2 | 5.63 | 14.8 | 55.8 | 21.1 | | | | | |
| New England Chromachem | 95 | 21.6 | 6.24 | 9.06 | 44.8 | 17.3 | | | | | |
| New England Testing ¹ | 100 | 23.0 | 4.9 | 12.0 | 52.0 | 18.0 | | | | | |
| Phoenix Environmental | 96 | 23.0 | 3.0 | 12.0 | 43.0 | 17.0 | | 2.00 | | | |
| Premier Lab | 95.6 | 22.0 | 4.9 | 12.0 | 44.0 | 17.0 | | | | | |
| Spectrum Analytical | 95.3 | 24.7 | 4.94 | 12.6 | 47.5 | 18.4 | | | | | |
| STL Westfield | 95.3 | 21.0 | 5.0 | 11.0 | 41.0 | 16.0 | | 0.83 | | | |
| Toxikon Corp. | 95.2 | 13.0 | 3.2 | 8.70 | 26.0 | 10.0 | 0.380 | | | | |
| Wall Experiment Station ² | 95 | 18 | 4.4 | 9.7 | 40 | 15 | | | | | |
| Woods Hole Analytical | 95.3 | 40 | 8.1 | 27 | 91 | 36 | | | | | 4.5B |
| Study Mean | 95.5 | 22.0 | 4.75 | 11.2 | 45.4 | 17.0 | | | | | |
| Standard Deviation | 1.1 | 5.9 | 1.22 | 4.3 | 13.3 | 5.6 | | | | | |

¹Katahdin Analytical and New England Testing data for 1,1,1-TCA, Benzene, TCE, and PCE taken from diluted runs, 'E' flagged on original run.

²All Wall Experimental Station results flagged with 'B' by Laboratory. B= Analyte detected in LB, LRB, and/or no trip blank collected.

MTBE , trichloroethane, and tetrachloroethane results flagged 'M' by laboratory indication analyte concentration between the MDL and RDL.

PART III: Arsenic

Chapter 4

TREATING ARSENIC-CONTAMINATED SOIL AT A FORMER HERBICIDE BLENDING FACILITY

Ajit K Chowdhury¹, Robert R Stanforth¹ and Ross Overby²

¹RMT, Inc., 744 Heartland Trail, Madison, WI 53717-1934; Tel: (608) 831-4444; E-mail: ajit.chowdhury@rmtinc.com and Robert.stanforth@rmtinc.com; ²URS Corporation, 500 12th Street, Suite 200, Oakland, CA 94607-4014; Tel: (510) 874-3084; E-mail: Ross.overby@urscorp.com

Abstract: Arsenic-contaminated soil at a Superfund site in Missouri was treated during 2005 using a ferric sulfate-based additive. Initial testing indicated that 20 percent Portland cement was needed to treat the soil; in contrast, only around 2 percent of the ferric sulfate additive was required. The exact dosage depended on the arsenic content of the soil. Arsenic screening using X-ray fluorescence (XRF) was used for the in-field determination of the dose required for each batch of soil. Varying levels of available iron in the soil was an additional factor in selecting the dose of treatment chemical. More than 70,000 tons were successfully treated and disposed, at an average chemical dose of 2 percent. The correlation of XRF arsenic data with wet compositional analysis, the relationship of available iron to arsenic ratio with TCLP-arsenic analysis, and the dosage-response for chemical treatment of soil comparing the bench-scale and full-scale treatment data are discussed.

1. INTRODUCTION

Arsenic is a known carcinogen and is one of the most commonly reported contaminants at U.S. EPA Superfund sites (USEPA, 2002). In the past, the most frequently used technology for remediating arsenic-contaminated soil at Superfund sites has been solidification/stabilization (S/S) with Portland cement (USEPA, 2002). Cement treatment gained an early endorsement from the USEPA because it physically binds the contaminants within a solid stabilized mass and reduces the hazard potential of the waste by limiting the solubility and mobility of the contaminants. A major disadvantage of the cement treatment process, however, is that it adds a lot of weight and bulk because of the relatively high additive dosages that are normally needed to solidify the waste. This additional weight results in higher handling and disposal cost. In recent years, a more cost-effective approach for remediating arsenic-contaminated soil has been chemical stabilization, in which the leaching and mobility potential of the contaminants are greatly reduced by the addition of pH control and adsorption/coprecipitation agents. Chemical stabilization uses much less additive dosage than cement treatment, which reduces disposal cost. In this instance, a proprietary, ferric sulfate-based chemical stabilization chemistry was used for soil stabilization at the subject site. In-field XRF arsenic analysis of the soil was used for dosage determination. Additionally, the additive dosage had to be controlled for a certain molar ratio of iron to arsenic for effective treatment. A case study on

chemical stabilization of arsenic-contaminated soil using the ferric sulfate-based chemistry is presented in this paper.

2. SITE HISTORY/BACKGROUND

A herbicide manufacturing/blending plant operated in North Kansas City, Missouri from the 1920s until 1986, when numerous chemical releases to the soil and groundwater occurred. The USEPA placed the site on the Superfund list (USEPA, 1999) with the focus on remediating the arsenic present in soil at concentrations exceeding 10,000 mg/kg. The contamination extended to 18 feet below ground surface (bgs), some of which was below the water table (14-20 feet bgs). Anthropogenic fill material was present up to a depth of about 5 feet bgs. The underlying native materials consisted of soft to medium-stiff silty clay to depths of up to 23 feet bgs.

When the U.S. EPA Region VII ordered the removal of the contaminated soil, much of the soil had to be stabilized because it exceeded the Toxicity Characteristic Leaching Procedure (TCLP) hazardous waste criterion of 5 mg/L for arsenic. To further reduce long-term risk, an additional regulatory requirement was added. The treatment chemistry had to demonstrate in bench testing that it could pass the U.S. EPA Multiple Extraction Procedure (MEP) for arsenic.

An initial treatability study evaluated soil stabilization using Portland cement. The recommended minimum dosage was 20 percent by volume cement to pass the TCLP and MEP criteria. Later, RMT, Inc. (RMT) of Madison, Wisconsin, tested its alternative EnviroBlend® ferric sulfate based treatment chemistry and found it to be more cost-effective.

3. BENCH-SCALE EVALUATION OF ENVIROBLEND® CHEMISTRY

Using site soil samples, RMT conducted a bench-scale treatability study using various mix ratios and dosages of the EnviroBlend® chemistry. A dose-response plot for bench-scale stabilization of the arsenic-contaminated soil is shown on Figure 1. The untreated soil contained 15,000 mg/kg total arsenic, with a TCLP arsenic concentration of 29 mg/L. EnviroBlend® dosages starting at 1 percent by weight treated the soil below the 5 mg/L TCLP-arsenic threshold concentration. On the basis of this bench-scale study, an average 2 percent by weight dosage was recommended for on-site soil stabilization to satisfy both the TCLP and the MEP criteria for arsenic.

Figure 1
Bench-scale Treatability Study Dosage Response

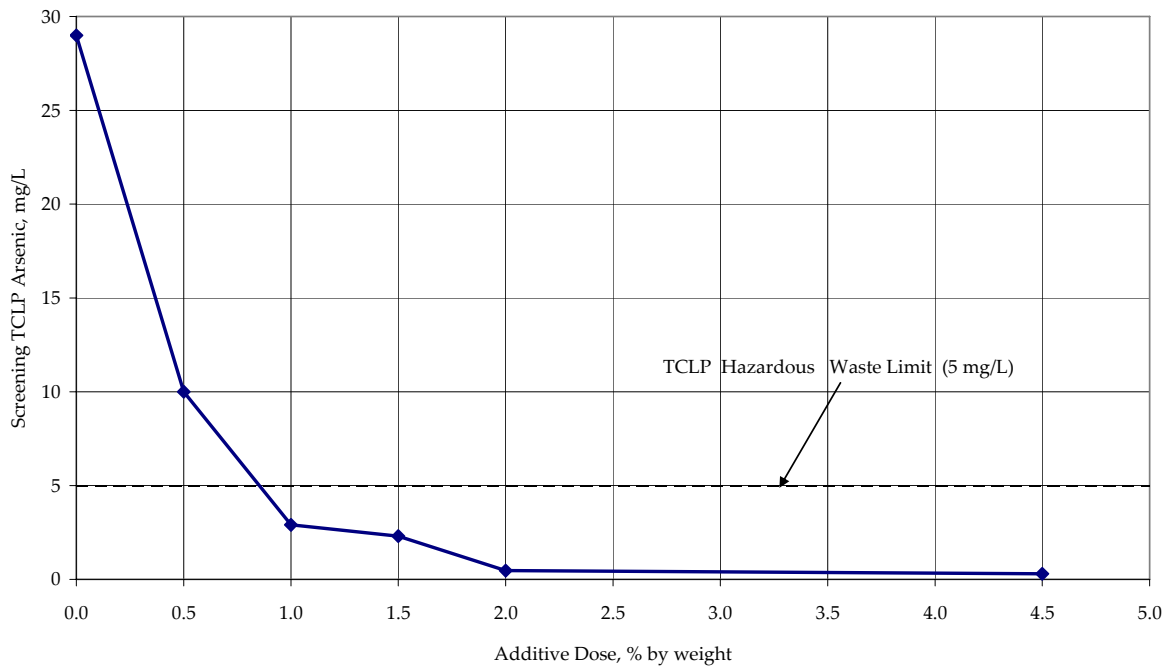

4. REMEDIATION APPROACH

The EnviroBlend® treatment chemistry was easier to implement compared to Portland cement in the highly visible and cramped quarters of the Armour Road site. EnviroBlend’s low dust characteristics allowed it to be stored on the ground and handled and mixed with a backhoe. The cement alternative would have required a big footprint pugmill/silo system that would needed to be moved at least twice.

The overall approach for full-scale remediation at the site included the following steps:

- Stockpile approximately 500 cubic yards (approximately 700 tons) of contaminated soil in a working area.
- Screen the soil in the field using XRF. Subject the untreated soil to the TCLP.
- Determine the EnviroBlend® dosage.
- Add and mix the treatment additives with the soil using an excavator.
- Subject the treated soil to the TCLP, to confirm treatment effectiveness.
- Add and mix more treatment chemicals, if needed, and retest.

The stabilized soil was hauled to a Subtitle D landfill while the excavation was backfilled with clean fill material.

5. FULL-SCALE TREATMENT RESULTS AND DISCUSSION

Soil treatment started with little variation in chemical dosage during the first phase of the soil remediation. On the basis of initial field data and the bench-scale treatability data, EnviroBlend® dosages were modified somewhat to reflect the variability of the arsenic concentration in soil as shown below:

| Soil Arsenic Concentration, mg/kg | EnviroBlend® Dosage, weight % |
|-----------------------------------|-------------------------------|
| <2,000 | 1.15 |
| 2,000-5,000 | 1.75 |
| 5,000-15,000 | 2.3 |

Approximately 11,000 cubic yards of soil were initially treated at dosages ranging from 0.75 to 2.3 percent by weight. Table 1 provides a summary of full-scale treatability data on the initial soil stockpiles.

Table 1. Initial Full-scale Treatability Data Summary

| | Dose | Pre Treatment | | Post Treatment |
|--------|---------------|----------------|--------------|----------------|
| | | Total Arsenic | TCLP Arsenic | TCLP Arsenic |
| Range | 0.75% - 2.30% | 1,700 – 10,600 | 1.7 – 63.6 | 0.28 – 2.90 |
| Median | 1.25% | 5,220 | 15.1 | 1.20 |
| Mean | 1.53% | 5,450 | 20.7 | 1.32 |

Notes: Number of samples included in this data set = 20

XRF analysis of the soil for arsenic proved to be a key cost-saving step in calculating the treatment dosage rates for each individual soil stockpile. To help ensure that the XRF analysis correlated reasonably well with the actual arsenic concentrations, the XRF field data were compared with the total arsenic data obtained using standard analytical methods by an off-site certified lab. Figure 2 presents a correlation of the in-field XRF data with the laboratory total arsenic data. The XRF data correlated well (correlation coefficient of 0.82) with the total arsenic data.

Figure 2
In-field XRF vs. Compositional Arsenic Analysis

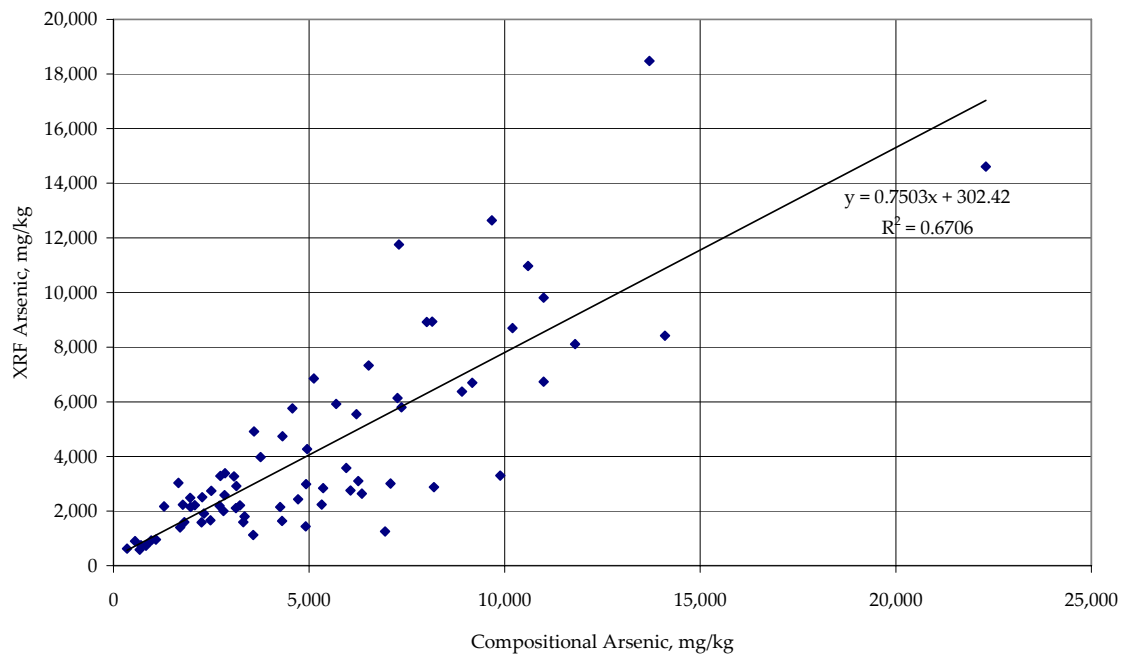

After the first 11,000 cubic yards of soil were treated and disposed, different soil/fill materials were encountered with higher total and TCLP-arsenic concentrations. Scaling up the treatment chemical dosage did not produce predictable results. Several of the stockpiles failed the TCLP after repeated additions of chemicals. Contributing to the problem was some material suspected of having high concentration of herbicides, which had TCLP arsenic levels of 520 mg/L. These values were an

order of magnitude higher than the concentrations observed during the initial periods of remediation and required chemical dosages that were almost an order of magnitude higher, as well. However, mixing the hot spot materials with the other site soils with lower arsenic levels made it more amenable to the stabilization treatment. The blended soil types could be treated with an overall chemical dosage that was lower than the combined additive requirements if the samples were treated separately.

To further investigate the potential synergistic effects of the strategic mixing of the remaining untreated site soils, several grab soil samples from different areas of the site were analyzed for “available” iron (using a cold acid digestion procedure developed by RMT). The data on available iron and total arsenic showed that most of the samples that were TCLP toxic for arsenic had an available iron to arsenic (Fe/As) mole ratio of 0.65 to 2.14. Additionally, the available iron content of most of the site soils was not high enough to serve as a source of iron to supplement the treatment additive.

A strong correlation was observed between the Fe/As mole ratio and the TCLP arsenic concentration of the site soils. Figure 3 shows a plot of the Fe/As mole ratio versus the soil TCLP arsenic concentration. Generally, an Fe/As mole ratio in the range of 3 to 4 or higher is needed for TCLP arsenic concentrations to be below the 5 mg/L threshold. These data agree well with published literature (Krause et al., 1985; Pappasiopi, et al., 1988) on the influence of Fe/As mole ratio and pH versus arsenic solubility for providing a robust environmentally safe chemistry for arsenic stabilization.

Figure 3
Effect of Available Iron/Arsenic Ratio on Soil TCLP Arsenic

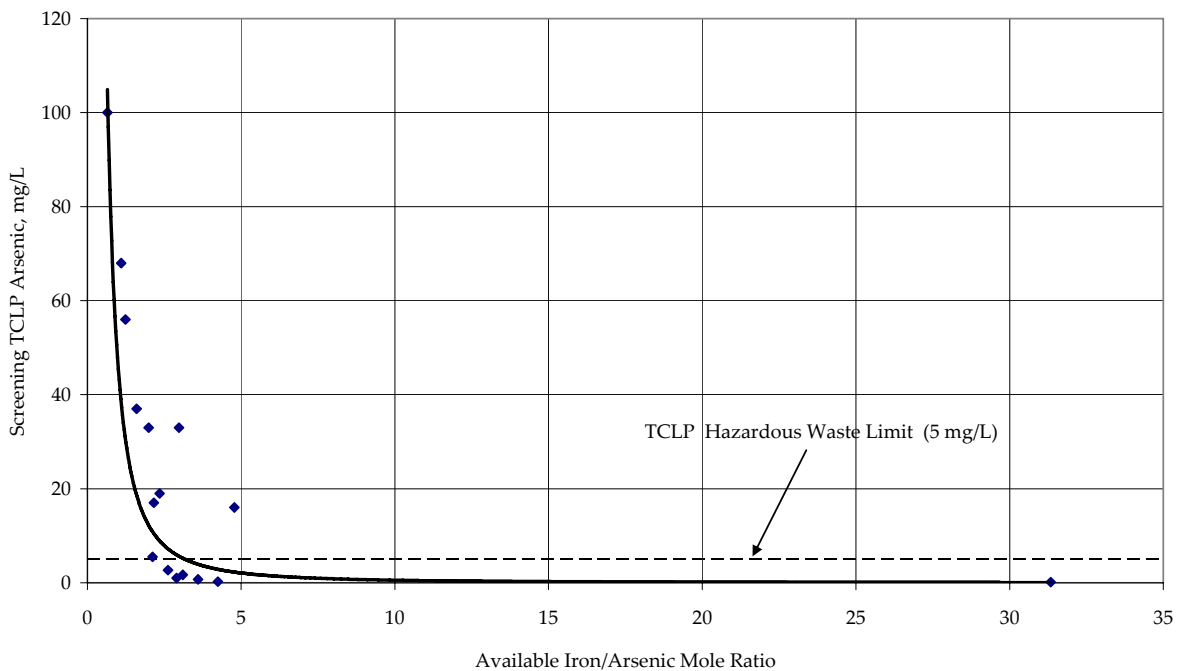

The on-site remediation activities continued with the additive dosage being controlled for adjustment of Fe/As mole ratio in the soil to treat material with a higher arsenic concentration material. An additive dosage of up to 13 percent by weight was needed to stabilize some of the higher arsenic soil stockpiles. A summary of the continued full-scale remediation treatability data is provided in Table 2. A total of approximately 70,000 tons of arsenic-contaminated soil were effectively stabilized using an approximate average additive dosage of 2.2 percent by weight.

Table 2. Continued Full-scale Treatability Data Summary

| | Dose | Pre Treatment | | Post Treatment |
|--------|----------------|---------------|--------------|----------------|
| | | Total Arsenic | TCLP Arsenic | TCLP Arsenic |
| Range | 1.25% - 13.00% | 965 – 22,300 | 2.0 – 126.0 | 0.02 – 4.35 |
| Median | 3.00% | 4,950 | 23.6 | 0.65 |
| Mean | 3.42% | 6,0.71 | 36.7 | 1.29 |

Notes: Number of samples included in this data set = 20

6. CONCLUSIONS

1. Arsenic-contaminated soil was effectively treated to render it non-TCLP toxic for arsenic using an average EnviroBlend® dosage of 2.2 percent by weight.
2. The available iron to arsenic ratio was a key factor in scaling up EnviroBlend® dosages with increased total arsenic concentrations in soil stockpiles. An Fe/As mole ratio of higher than 3-4 was essential for effectively stabilizing arsenic in soil.
3. In-field XRF arsenic analysis correlated well with total arsenic concentrations measured by standard laboratory analysis. The XRF analysis was very effective in delineating soil arsenic levels in soil stockpiles and in expediting chemical dosage optimization during on-site remediation.

REFERENCES

- Krause, E., and Ettel, V.A. 1985. Ferric Arsenate Compounds: Are They Environmentally Safe? Solubilities of Basic Ferric Arsenates. Proceedings of CIM Metallurgical Society, 15th Annual Hydrometallurgical Meeting, May 1-20.
- Papassiopi, N., Stefanakis, M., and Kontopoulos, A. 1988. Removal of Arsenic from Solutions by Precipitation as Ferric Arsenates, Arsenic Metallurgy Fundamentals and Applications. Symposium Proceedings, 1988 TMS Annual Meeting and Exhibition, Phoenix, Arizona, 321 to 334.
- USEPA (U.S. Environmental Protection Agency). 2002. Arsenic Treatment Technologies for Soil, Waste, and Water. Office of Solid Waste and Emergency Response. EPA-542-R-02-004. September 2002.
- USEPA (U.S. Environmental Protection Agency). 1999. NPL Site Narrative for Armour Road, Armour Road, North Kansas City, Missouri. Federal Register Notice. May 10, 1999.

Chapter 5

DERIVATION OF SITE-SPECIFIC ARSENIC BACKGROUND IN SOIL: A CASE STUDY

Matthew J. Mortefolio, P.E.

Environmental Engineer, New York State Department of Environmental Conservation, Division of Solid & Hazardous Materials, 625 Broadway, Albany, NY 12233, (518) 402-8594, mjmortef@gw.dec.state.ny.us

Abstract: During the course of site environmental investigations where arsenic is one of the principal contaminants, it often becomes necessary to determine arsenic background in soil in order to define the extent of the arsenic contamination from the site and, in some cases, to help establish an appropriate cleanup level. Arsenic background in soil often has two components, one being “natural” background, related to local geology, and the other being “anthropogenic” background from human activities not associated with the site. For sites located in mostly pristine areas, it is likely that only natural background is involved, which in the eastern half of the United States is fairly consistent over a very limited range of arsenic concentrations. For these sites, arsenic background in soil can be established fairly easily through use of existing regional data or from a limited sampling of soil in areas unaffected by the site. However, for sites where the arsenic contamination is extensive over a large off-site area and anthropogenic sources other than the site itself are suspected to have contributed to arsenic levels in soil within that area, the determination of arsenic background applicable to the site becomes more complex. This paper discusses some of the challenges presented in estimating arsenic background for sites where different degrees of non-site related anthropogenic activity are involved, and presents a case study of how arsenic background in soil was established at one such site.

Key words: Arsenic; Background; Soil.

1. INTRODUCTION

For sites where arsenic is a significant constituent of concern in soil, it is important to determine the site’s background concentrations (i.e., arsenic present in the soil, exclusive of any contribution from the subject site) in order to define the extent of soil arsenic contamination from the site. This is usually accomplished by comparing soil arsenic background data to soil arsenic data from the site to define the areas where arsenic concentrations are elevated due to releases from the site. Also, it may be necessary to establish background arsenic concentrations for a site in order to evaluate background as a potential cleanup goal. In many cases remediating all site related arsenic contamination is a remedial option, and as such one needs to establish the site’s background in order to adequately evaluate this remedial option.

Arsenic Background has two components: Natural and Anthropogenic. Natural Background arsenic concentrations found in a soil are those which are related to the arsenic content of geological materials from which the soils are derived. In New York State soils, these typically range from about 1 to 5 ppm. Anthropogenic Background arsenic concentrations found in a soil are those which have resulted from mans’ activities, exclusive of activities at the subject site. Arsenic from historic man-made sources includes such things as pesticide usage in orchards or as a wood preservative by the lumber industry. It also could include past retail usage such as an active ingredient in crab grass killer. The range of arsenic concentrations in soil attributable to man-made sources can vary widely and is mainly dependent on the degree and duration of anthropogenic activity. This anthropogenic

variability creates a number complex challenges to estimating arsenic background in areas where anthropogenic arsenic sources, other than the site, are suspected of contributing to soil arsenic concentrations.

1.1 The Case Study

This paper will walk through the process that was used to estimate arsenic background in soil for a site in western New York. In presenting this process, the paper will discuss the various challenges that were faced along the way and how each was managed. It will discuss the development of the background soil sampling strategy, implementation of soil sample collection, presentation and management of the resultant soil arsenic background data, and estimation of the site-specific arsenic background.

There are a number of general principles that are presented by this case study that can be applied to the development of background at other sites, as well as for other constituents. However, it is important to note that the specific methods used in this case study represent just one possible approach. This is not a “one-size-fits-all” methodology. It should also be noted that the methods in this case study are most appropriate for sites where the arsenic contamination extends off-site and other significant anthropogenic sources of arsenic are suspected. These methods are not applicable or necessary for sites where “natural” arsenic concentrations are likely the most significant component of the site’s background. For such sites using existing background data from State or Regional sources, or perhaps collecting a few soil samples from an unaffected area, should be sufficient.

2. MATERIAL AND METHODS

2.1 Site & Community Characterization

A common first step in developing a background sampling strategy is the characterization of the site and its surrounding community. This involves determining the mechanisms and migration paths of arsenic releases from the site, as well as identifying the types of properties and other features which surround the site.

The case study site is a pesticide manufacturing plant that produced arsenic based pesticides from the late 1920s through the mid-1970s. The site released arsenic production wastes to surface water both through direct discharges and surface run-off from on-site disposal areas. These arsenic surface water releases migrated down a creek and a storm water drainage pathway, impacting both sediments within these waterways and soils within their flood zones. The site also released arsenic as a result of air emissions from its pesticide production process. These arsenic air releases were deposited on surface soils within the site community, most significantly in predominantly downwind areas. The site community is made of a Residential Area, an Agricultural and Wooded Area, an Industrial and Commercial Area, and historically some Orchard Areas.

2.2 Background Community & Property Type Selection

There are two important guidelines that should be used in selecting a Background Community to collect soil samples for arsenic analysis. The first is that it must be unaffected by site arsenic releases, and the second is that it must be similar to the Site Community in terms of property and soil types. Property type similarity is important to assure similar degrees of arsenic anthropogenic activity between the Site and Background Communities (exclusive of the site itself). Soil type similarity is important since arsenic concentrations in soil can be influenced somewhat by the soil matrix. For instance, arsenic concentrations may be higher in a tight clay than in a loose sand due to the higher degree of molecular bonding found in charged clay particles.

The case study Background Community is approximately 5 miles away from the site, generally upwind of the site and in a separate drainage area. As a result, there was a high degree of confidence that the Background Community was not measurably impacted by arsenic releases from this site.

The case study Site and Background Communities were found to be very similar. Both have Residential, Agricultural, Wooded, Industrial and Commercial areas. They also share other features such as a school, a creek, a canal, a highway and a rail line. In addition, the Background Community included orchards representative of the historic orchards identified in the Site Community. Specific property types selected to represent those in the Site community where agricultural (farm fields), wooded, residential, public (school), commercial, industrial and orchards. The soil types in the Site and Background Communities were examined and found to be similar in that they were both generally made up of native brown clay and some glacial deposits of sand and silt. As a result, the Background Community was judged sufficiently similar to the Site Community (in terms of property and soil types) for the purpose of the comparison background case study.

2.3 Determining an Appropriate Sample Quantity

There are a two general guidelines that are useful in determining how many background soil samples to collect for arsenic analysis. The first is to collect sufficient samples to adequately represent the soil arsenic character of the Background Community, without collecting excess samples which would do little to improve the arsenic character representation. Since arsenic concentrations can vary in a soil over an area, especially where differing degrees of anthropogenic usage are involved, collecting a handful of samples from one or two properties could lead to anomalous results which may not represent the true arsenic character of the Background Community. Different property types may have different soil arsenic characters due to differing degrees of arsenic anthropogenic activity. This can result in a stratified data set, where the arsenic data for a particular property type are similar, but the arsenic data between different property types are not similar. Such stratified data makes it difficult, if not impossible, to obtain sufficient arsenic data to adequately represent the Background Community as a whole because of the different ranges of arsenic concentrations that can result from one property type to another. This data sufficiency challenge can be managed by grouping property types with anticipated similar degrees of arsenic anthropogenic activity and collecting sufficient data to represent the arsenic character of each property group separately.

For the case study, four (4) property groups were established where the arsenic anthropogenic activity within the groups was anticipated to be similar. Agricultural (non-orchard) properties were grouped with wooded properties since historic records indicated little, if any, arsenic usage on these type properties. Residential and public properties were grouped to account for the potential of some past arsenic usage in gardens or on lawns. Commercial and industrial properties were grouped due to the potential for past usage as a weed killer and as a preservative in wood found in area lumber yards. Lastly, orchards were left as a separate group since historical records indicated a potential that the arsenic usage in orchards might be significantly higher than in the other property groups.

The second guideline is to maintain proportionality between the site and background community property types with regard to sample quantity. If the Site Community is 60% residential and 5% orchards, collecting 5% of the background samples from residential properties and 60% from orchards will not be appropriately representative of the Site Community, and will likely bias results towards the orchard's arsenic character. One way to manage this proportionality challenge is to derive Weighting Factors (or percentages) for each property group that can be used to keep the Site and Background data sets proportional to one another in terms of property types. These weighting percentages can be derived from the land area of each property group within the Site Community during the time period over which the arsenic releases occurred.

For the Case Study, a number of historic aerial photos and Sanborn property maps (developed for insurance purposes) of the Site Community were used to determine the land area of each of the four (4) property groups during the roughly 50 year period of arsenic releases from the site. After reviewing a number of these photos and maps, it was evident that the land area of the different decreased over the period, while residential and wooded land was on the increase. To address these

temporal changes, two (2) property maps were developed of the Site Community, one representing the period from 1938 to 1958 and the other representing that from 1958 to 1978. For each map, the land area of each property group was derived and divided by the total land area of the Site Community, to come up with a land area percentage for each group applicable to the time period represented by the map. The resultant weighting percentage was subsequently derived from a time-weighted average of each group's land area percentage from the two maps. This resulted in weighting percentages of 55% for the Agricultural/Wooded Property Group, 33% for the Residential/Public Property Group, 9% for the Commercial/Industrial Property Group, and 3% for the Orchard Property Group.

Using these weighting percentages, a statistically sufficient number of samples were estimated for each property group in the case study by utilizing Eq. (1) which is specifically designed for stratified data sets.

$$n_{gn} = n_{Ti} W_g s_{gi} / \sum W_g s_{gi} \quad (\text{Gilbert, 1987, p.50}) \quad (1)$$

Where: n_{Ti} = initial number of sample points in the entire data set;
 W_g = weighting percentage of each property group; and
 s_{gi} = initial standard deviation of each group's data set.

This equation divides the weighted standard deviation of the initial data from a property group by the summation of the weighted standard deviations of the initial data from all four (4) property groups. In order to estimate the number of samples for each property group (n_{gn}), values for n_{Ti} and s_{gi} were derived from an assumed data set. This assumed data set was based on certain expectations. For instance, it was expected that a larger data set would be needed for the Agricultural/Wooded Property Group since this group has a relatively large weighting percentage (55%). The results indicated that about 75 samples would be needed, and the following Table 1 presents the sampling parameters that were derived for each property group:

Table 1. Property Group Sampling Parameters

| Property Group Sampling Parameters | Agricultural / Wooded Group | Residential / Public Group | Commercial / Industrial Group | Orchard Group |
|---------------------------------------|--------------------------------|-------------------------------|----------------------------------|---------------|
| Wg | 0.55 | 0.33 | 0.09 | 0.03 |
| sgi | 4.54 | 7.11 | 8.01 | 14.09 |
| ngn | ≈ 28 samples | ≈ 23 samples | ≈ 12 samples | ≈ 12 samples |
| # of Properties | 7 | 8 (1 school) | 3 | 4 |
| # of Samples/Property | 4 | 3 | 3 | 4 |

2.4 Soil Sample Collection and Analysis

After the initial sampling parameters have been established, specific properties need to be selected that are similar to those in the Site Community. For example, in the case study some residential properties were selected along a creek to represent similar properties along the creek in the Site Community. Next permission to access each property for sample collection must be obtained. This can be difficult sometimes and may require some public relations skills. Sample points must be selected on each property similar to those in the Site Community. For instance, in the case study, sample points were selected in flood zones and in ditches to represent those features found in the Site Community. Surface soil samples 0 to 3 inches deep were collected for the case study, which was analogous to much of the sampling in the Site Community. Twice as many samples than determined to be necessary were collected and archived for each case study property from different sample points. This was done in order to avoid having to conduct another sampling round in the event that the evaluation of the initial data indicated that more data is needed to adequately characterize certain property groups. The initial samples obtained for the case study were analyzed for total arsenic using the same analytical method used on samples from the Site Community.

3. RESULTS

3.1 Determining Data Sufficiency

Once the initial raw data is obtained, it is first necessary to determine if there is sufficient data to adequately represent the arsenic character of each property group. This is accomplished by utilizing Eq. (1), with the initial total number of data points (n_{Ti}), the property group’s weighting percentages (W_g) and the standard deviations derived from each property group’s initial data set (s_{gi}). Results will indicate the number of samples needed for each property group (n_{gn}) to adequately represent the group’s arsenic character. If this value is less than or equal to the property group’s initial number of samples analyzed, the group’s initial data set is judged sufficient to represent the group’s arsenic character. If the resultant value is greater than the group’s initial data set, additional samples may need to be analyzed to provide sufficient arsenic data for the property group, and the data sufficiency re-calculated in an iterative process.

For the case study, it was determined that the amount of data needed for the Agricultural / Wooded Property Group ($n_{a/w n}$) was 51 samples, which was well above the 28 samples initially analyzed from this group. All other groups were determined to have sufficient arsenic data. It was decided to analyze an additional 28 archived samples from the Agricultural / Wooded Property Group, for a total of 56 samples. After receiving the arsenic data from the group’s additional samples, the number of samples needed for the group was re-calculated from the group’s initial and additional arsenic data. This indicated that 63 samples were needed for the Agricultural / Wooded Property Group, which was approximately equal to the 56 samples analyzed. Since this resulted in a data shortage of less than 10%, it was decided that the 56 arsenic data points were sufficient to adequately represent the soil arsenic character of the Agricultural / Wooded Property Group.

3.2 Checking for Outliers

Each property group’s data set should be checked for possible outliers, (arsenic data points which are at the extreme ends of the group’s data range and may not be representative of the group’s true arsenic character). There are a number of statistical methods that can be used to test for outliers. However, in order to utilize these methods, it is first necessary to determine each property group’s data distribution (i.e., whether it best conforms to a “normal” or “log-normal” distribution type). This can be done visually from data distribution graphs or through use of a Linear Regression (Best-Fit Curve) Analysis (Johnson, 1980, p.101). Depending on the distribution type, either the actual or natural log (ln) values are used to make a Box & Whisker Plot (EPA, 1998, p.2.2-1) of each group’s data set to screen for possible statistical outliers.

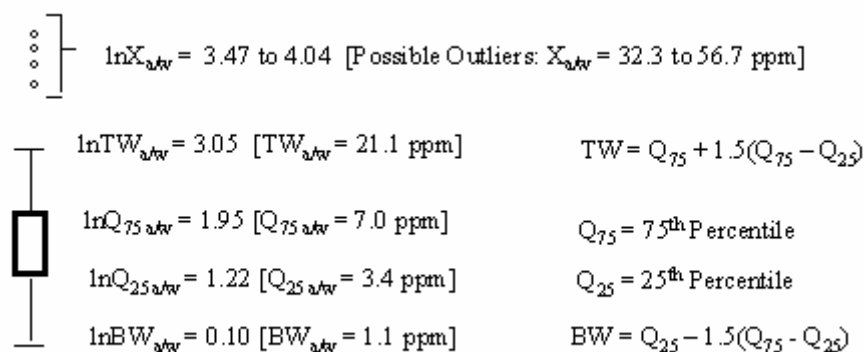

Figure 1. Box & Whisker Plot of Agricultural / Wooded Data

Each of the property group data sets in the case study were determined to conform to a log-normal distribution, so natural log (ln) data values were used to construct the Box & Whisker Plots. Figure 1 presents the Box & Whisker Plot of the Agricultural / Wooded Group's Data Set.

The Box & Whisker Plot of the Agricultural / Wooded Property Group's Data Set tentatively identified four (4) statistical outliers ranging from 32.2 to 56.7 ppm. Other statistical tests should be employed to help confirm tentatively identified outliers, such as Rosner's Test (Gilbert, 1987, p.189), which is applicable to data sets of 25 or more. Rosner's Test uses the absolute difference between each potential outlier (x_g^i) and the mean of the group's data set (0_g^i), divided by the standard deviation of the group's data set (s_g^i), in order to calculate Rosner's Test Statistic ($R_{g\ i+1}$) for each of the group's tentative outliers.

$$R_{g\ i+1} = |x_g^i - 0_g^i| / s_g^i \quad (\text{Gilbert, 1987, p.189}) \quad (2)$$

For each tentative outlier in a group's data set, the result from Eq. (2) is compared to tabulated Critical Values (λ_r) (EPA 1998, p.A-7) to evaluate the tentative statistical outlier. Regardless of the outcome of the statistical tests, careful judgement should be employed before determining to use or neglect any identified outliers.

For the Case Study, the natural log (ln) data values were again used and the results of Rosner's Test confirmed that there were 4 statistical outliers ranging from 32.3 to 56.7 ppm in the Agricultural / Wooded Group's Data Set. A closer examination of historical aerial photos of the property in the Background Community where some of the outlier samples were obtained indicated the presence of an old orchard in the area. Since the arsenic values of these outliers were well within the range of the orchard group's arsenic data, it appeared that these values may have resulted from a higher degree of arsenic usage anticipated to have occurred in orchards. While these arsenic values may be representative of the Orchard Group's arsenic character, they did not appear to represent the Agricultural / Wooded Group's true arsenic character, and therefore neglecting these outliers seemed appropriate.

3.3 Data Presentation

Table 2 presents the data summary of the case study results for each Property Group:

Table 2. Case Study Tabulated Data Summary

| Statistical Parameters | Agricultural / Wooded Group | Residential / Public Group | Commercial / Industrial Group | Orchard Group |
|------------------------|-----------------------------|----------------------------|-------------------------------|-----------------|
| # of Samples ng | 52 samples | 23 samples | 12 samples | 12 samples |
| Range | 2.3 to 11.9ppm | 3.3 to 21.1ppm | 3.3 to 32.8ppm | 3.1 to 121.3ppm |
| Mean g | 5.0ppm | 10.1ppm | 11.7ppm | 33.3ppm |
| Median | 4.3ppm | 8.6ppm | 6.4ppm | 14.7ppm |
| Std. Dev. Sg | 2.1ppm | 5.3ppm | 9.8ppm | 36.8ppm |
| 95th Percent. Q95 | 9.4ppm | 20.3ppm | 32.8ppm | 121.3ppm |

FOOTNOTE: Agricultural / Wooded Group outliers excluded.

There are a number of interesting aspects that can be observed from this tabulated data. First, the range and standard deviation of the Orchard Group's data are both considerably larger than the ranges and standard deviations of the other 3 groups. This would suggest a highly variable level of arsenic anthropogenic activity in orchards as was originally suspected. Second, the mean and median of the Orchard Group's data are at the low end of the group's range indicating that there are only a few arsenic data points at the high end of the group's range. Finally, both the mean and 95th Percentile increase progressively from the Agricultural / Wooded Group to the Orchard Group. This would suggest a progressively increasing degree of arsenic anthropogenic activity from group to group in the manner originally anticipated.

Figure 2 is a graphic presentation of the case study data distribution.

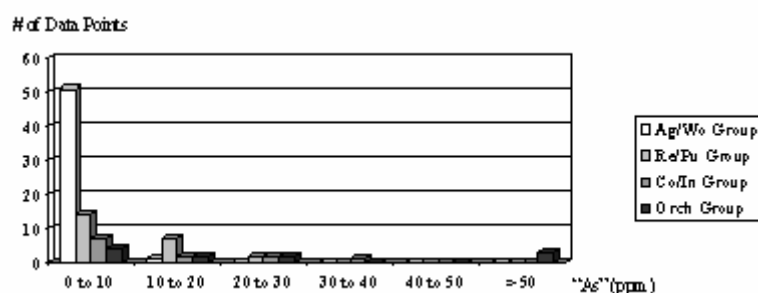

Figure 2. Background Data Distribution

Figure 2 presents a bar graph of the number of data points, shown on the vertical axis, within the specified ranges of arsenic concentrations, shown on the horizontal axis. As can be seen from this graph much of the data falls within the 0 to 20 ppm arsenic concentration ranges, with the Orchard Group being the only group with data points above 50 ppm.

3.4 Data Management

Use of the case study data in its current form (separated between property groups) may be problematic. How should separate background data sets be compared to site data? Can one background set be used for site residential property and a different background set for historic orchard property? What background data set should be used for site residential properties that were once orchards, residential or orchard background? While use of separate background data sets may be appropriate in some situations, derivation of some statistical parameters that appropriately represent the entire background data set may help in making comparisons to site data.

In order to derive such statistical parameters, it is first necessary to determine the overall data distribution (i.e., whether it best conforms to a “normal” or “log-normal” distribution type or is undefined). This can again be done visually from data distribution graphs or through use of a Linear Regression (Best-Fit Curve) Analysis (Johnson, 1980, p.101). Due to its stratified nature, the case study overall data set did not conform to any standard distribution, and therefore was determined to have be undefined.

While there are a number of equations available to derive appropriately weighted statistical parameters for stratified data sets that approximate normal or log-normal distributions (Gilbert, 1987), they are not entirely appropriate for data sets that don’t conform to these distributions. For these type data sets it is necessary to utilize Monte Carlo Simulations to derive weighted statistical parameters. Monte Carlo Simulations are computer generated simulations that use an iterative process to come up with a “best-fit” of the weighted data points upon which the appropriate statistical parameters are derived.

For the case study overall background data set, Monte Carlo simulations were run using the weighting percentages representing each property group and each group’s arsenic data, to derive weighted statistical parameters. Below are some of the results:

- Weighted Mean: $O_w = \underline{8.1 \text{ ppm}}$
- 95% Upper Confidence Limit on the Weighted Mean: $UCL_{95}[O_w] = \underline{8.7 \text{ ppm}}$
- Weighted 95th Percentile: $x_{95w} = \underline{19.2 \text{ ppm}}$
- 95% Upper Confidence Limit on the Weighted 95th Percentile: $UCL_{95}[x_{95w}] = \underline{28.2 \text{ ppm}}$

4. DISSCUSSION AND CONCLUSIONS

4.1 Estimating Site-Specific Arsenic Background

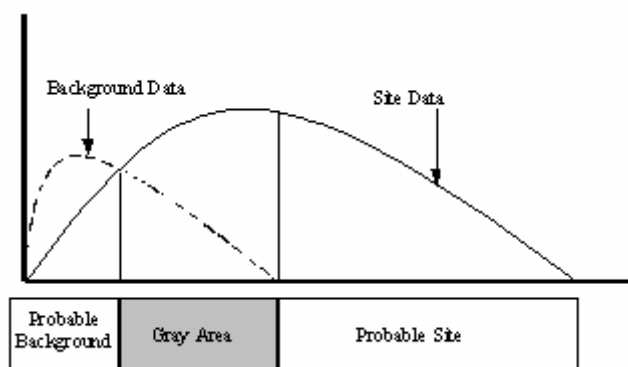

Figure 3. Typical Background & Site Data Distribution Curves

The problem in estimating background can best be seen by the typical data distribution graphs presented in Figure 3. Arsenic concentrations which fall to the left of the intersection of the two curves can probably be assumed to be background arsenic concentrations, while arsenic concentrations which fall to the right of the end of the background curve can probably be assumed to be site-related arsenic concentrations. However, discerning site from background for arsenic concentrations that fall within the middle “gray area” is more challenging.

In trying to estimate background with regard to this gray area, there are Competing Considerations involved. One is the need to be sure with a high degree of confidence that the arsenic is site related. This consideration advocates for the establishment of a high background threshold, somewhere near the high end of the background data curve. The other and somewhat opposite consideration is the need to be sure with a high degree of confidence that the arsenic is **not** site related. This consideration advocates for the establishment of a low background threshold, somewhere near the low end of the gray area. However, there is more to this than a simple academic probabilistic exercise. There are, of course Human Health & Environmental Risks associated with Arsenic. These risks should also be considered when estimating arsenic background from data.

There are basically a couple of approaches to estimating site-specific arsenic background. The first is to perform a detailed statistical comparison of the site and background arsenic data sets. There are statistical methods available for such data set comparisons. However, while these methods may take some of the guesswork out of estimating background, they are complex and may be difficult to apply to every situation. Also, they also do not have a mechanism for factoring in arsenic human health and environmental concerns in an estimate of background. The other approach is to establish an upper threshold estimate of arsenic background, above which arsenic concentrations would be considered to have a site-related component. Since this is more of a judgmental approach, it can be argued that it is susceptible to larger margins of error. However, it does allow consideration of the degree of confidence placed in whether an arsenic concentration is or is not site related. It also allows arsenic human health and environmental considerations to be factored in to the estimate.

4.2 Case Study Estimated Arsenic Background

After reviewing the background arsenic data and the associated statistical parameters, as well as factoring in arsenic human health and environmental concerns, an arsenic concentration of 20.0 ppm was selected as an upper threshold estimate of arsenic background for the case study. There were a number of important factors that contributed to this conclusion. First, 20.0 ppm is approximately equal to 19.2 ppm, which is the Weighted 95th Percentile of the entire background data set, and it is approximately equal to 20.3, which is the 95th Percentile of the Residential / Public portion of the

background data set. Therefore, 20.0 ppm was considered to provide an adequate level of confidence that arsenic concentrations above this limit are potentially site related. Second, 89 of the 99 arsenic data points fell at or below 20.0 ppm, and 76 of the 99 arsenic data points fell at or below 10 ppm, indicating a Background data distribution predominantly in the 0 to 20.0 ppm range. Therefore, 20.0 ppm was considered to provide an adequate level of confidence that arsenic concentrations below this limit are only background related. Finally, with regard to human health and environmental concerns, it was observed that 20.0 ppm falls within EPA's acceptable arsenic carcinogenic range and is below EPA's toxic threshold for arsenic.

4.3 Concluding Summary

In summary, below are some guiding principles resulting from this case study that might be applicable to derivations of site-specific arsenic background in soil at other sites:

- Background Community Unaffected & Similar – The community where background samples are collected must not be affected by releases from the subject site and should have property types and other features which are similar to those of the site community.
- Arsenic Anthropogenic Activity – Any current or historic non-site related potential arsenic anthropogenic activity in the Site Community should be identified and accounted for in the development of the background sampling program.
- Proportional Sampling – There should be proportionality between the site and background sample quantities in terms of property types. A site community that is 75% residential property should not have 75% of the background samples collected from orchards.
- Representative Number of Samples – A sufficient number of samples must be analyzed to insure that the data is statistically representative of the soil arsenic character of each property type in the Background Community.
- Outlier Check - Some statistical methods should be employed to check for outliers in the background data sets. If outliers are identified, careful judgment is needed on how they should be handled.
- Preview Data - Tabulate and graph the background data to visualize it to help determine if there are any discernable trends.
- Appropriate Background Statistics - Derive some appropriate statistical parameters from the background data to assist in estimating background.
- Arsenic Human Health & Environmental Risks - Some consideration should be given to arsenic human health and environmental risks in estimating background.

ACKNOWLEDGEMENTS

Thanks to Mr. Jim Ridenour of the New York State Department of Health for his assistance, and Professor Alan Rabideau of the State University of New York who assisted in the original peer review.

REFERENCES

- Gilbert, Richard O. 1987. *Statistical Methods for Environmental Pollution Monitoring*, Van Nostrand Reinhold Publishing, 1987.
- USEPA (U.S. Environmental Protection Agency Publication) 1998. *Guidance for Data Quality Assessment*. Publication EPA QA/G-9, January 1998.
- Johnson, Robert. 1980. *Elementary Statistics*. 3rd Edition, Wadsworth Publishing, 1980.

Chapter 6

USING MULTIPLE LINES OF EVIDENCE TO DEMONSTRATE THAT ELEVATED ARSENIC GROUNDWATER CONCENTRATIONS ARE NATURALLY OCCURRING

John R. Nelson, P.G.¹, Gail L. Batchelder, Ph.D., P.G., L.E.P.², Mark E. Radville, P.G.¹, and Sherry A. Albert, P.E.³

¹Massachusetts Water Resources Authority, 100 First Avenue, Charlestown Navy Yard, MA 02129; ²Loureiro Engineering Associates, Inc., 100 Northwest Drive, Plainville, CT 06062; ³Weston & Sampson Engineers, Inc., Five Centennial Drive, Peabody, MA 01960

Abstract: It has been widely documented that in many parts of New England, background concentrations of arsenic in groundwater may exceed existing and/or proposed standards. Consequently, the need to document that concentrations detected above the standard values are, in fact, representative of naturally occurring arsenic concentrations and not the result of an anthropogenic release of arsenic to the environment has become increasingly important in recent years.

The study site is located in central Massachusetts, adjacent to a tributary to a public water supply reservoir. During the course of an investigation to evaluate the potential for subsurface discharge of non-contact cooling water, groundwater samples were collected from overburden and bedrock aquifers. Laboratory analysis indicated that elevated concentrations of arsenic were present in several samples. At some of those locations, detected concentrations in overburden and bedrock groundwater exceeded the reportable concentration for arsenic under the Massachusetts Contingency Plan of 0.050 mg/l (subsequently decreased to 0.010 mg/l), which triggered the need for further evaluation of subsurface conditions.

In this study, multiple lines of evidence were used to support the position that elevated concentrations of arsenic were due to natural dissolution of arsenic-bearing minerals in the overburden and bedrock aquifers. These lines of evidence included: historical information that did not support any use or disposal of arsenic-bearing materials; available geologic mapping; field observations of overburden and bedrock encountered during well drilling; total concentrations of arsenic, iron, and manganese and microprobe analyses indicating the presence of arsenic-bearing minerals in overburden materials; and evaluation of geochemical characteristics (pH, dissolved oxygen, oxidation/reduction potential) of groundwater samples.

Key words: arsenic; Massachusetts; New England; Massachusetts Contingency Plan; MCP; groundwater; geochemistry; background concentration; naturally occurring arsenic.

1. INTRODUCTION

1.1 Purpose of Study

Arsenic was detected in groundwater at concentrations exceeding regulatory standards in overburden and bedrock wells at a site located within a public water supply watershed in central Massachusetts. This condition required further evaluation under applicable state regulations. Consequently, an investigation was undertaken to evaluate the source of the arsenic, specifically to determine whether or not the observed concentrations represented a naturally-occurring condition or were due to a release of hazardous materials.

1.2 Background Information

Arsenic in drinking water has been widely recognized as having significant impacts on human health and has been identified as one of the leading environmental causes of cancer mortality worldwide (Welch et al., 2000). The disastrous health impacts of consumption of arsenic-contaminated groundwater in Bangladesh have been well documented and have been cited as “one of the World’s worst disasters affecting humans” (Ravenscroft et al., 2001). Worldwide, background concentrations of arsenic are typically less than 0.01 milligrams per liter (mg/l), but can range over four orders of magnitude from less than 0.0005 to 5.0 mg/l (Smedley and Kinniburgh, 2003). Over 28 million people worldwide are estimated to consume water with greater than 0.05 mg/l of arsenic, and an even larger number are exposed to concentrations greater than 0.01 mg/l (Ravenscroft et al., 2001).

In response to the mounting evidence of severe health impacts, the World Health Organization (WHO) lowered its drinking water guideline from 0.05 mg/l to 0.01 mg/l in 1993. Many international environmental authorities followed the WHO lead, including the U.S. Environmental Protection Agency (EPA), which set the Maximum Contaminant Level (MCL) at 0.01 mg/l in 2001 (Smedley and Kinniburgh, 2003).

1.3 Natural Arsenic Occurrence in the Environment

Arsenic is a ubiquitous, semi-metallic element found in numerous types of environmental media, including bedrock, unconsolidated overburden materials, sediments, surface water, groundwater, and the atmosphere, as well as in the tissues of organisms. It is mobilized and redistributed in the environment through a variety of natural processes such as weathering, geochemical reactions and biological activity, and also as a result of many anthropogenic activities.

In a nationwide survey of arsenic occurrence and geochemical controls, the U.S. Geological Survey (USGS) found that concentrations of naturally occurring arsenic varied with climate and geology. Slightly less than half of 20,000 groundwater samples collected throughout the United States contained arsenic at concentrations below 0.001 mg/l, and about 10% contained arsenic at concentrations above 0.01 mg/l. The study identified New England as an area with elevated naturally occurring arsenic in groundwater that was primarily due to bedrock sulfide mineralization (Welch et al., 2000). Other USGS studies of elevated arsenic concentrations in New England drinking water, including bedrock public supply wells, attempted to correlate elevated occurrence of arsenic in groundwater with regional geology in an effort to predict where elevated concentrations may be found. These studies identified the Worcester, Massachusetts region, which includes the study area, as having arsenic concentrations in groundwater exceeding 0.02 mg/l (Ayotte et al., 2003; Ayotte et al., 2006).

Specifically, an area extending from northern Connecticut, through Massachusetts and into New Hampshire and Maine was identified as having moderate to high (0.01 to 0.05 mg/l) arsenic concentrations in groundwater-supplied drinking water. The elevated arsenic was primarily confined to bedrock water supply wells and was statistically more likely to occur in calcareous metasedimentary rock with high groundwater pH. In addition, areas of Pleistocene marine inundation and locations near granitic plutons with associated hydrothermal mineralization exhibited elevated concentrations. However, the study also reported that anthropogenic sources may also have an influence on elevated arsenic concentrations through the use of arsenical pesticides from the early 1900s through the 1960s.

2. REGULATORY COMPLIANCE

2.1 Discovery of the Arsenic Problem

The Massachusetts Water Resources Authority (MWRA) is a regional water and sewer utility that provides wholesale water and sewer service to 46 cities and 43 towns in the Boston Metropolitan area, as well as water services to several communities in the Chicopee Valley area of central Massachusetts. The source of the MWRA water supply is two large reservoirs, the Quabbin and Wachusett Reservoirs in central Massachusetts.

As part of the water transmission and distribution system, the MWRA operates a facility in West Boylston, Worcester County, Massachusetts, at the terminus of an aqueduct that connects the Quabbin and Wachusett Reservoirs. To take advantage of the head loss between these two reservoirs, a 3.5-megawatt hydroelectric generator is operated at this facility.

Arsenic was first detected in groundwater during a hydrogeological study conducted at the site in 2001 to evaluate the feasibility of recharging non-contact cooling water from the facility's hydroelectric generator directly to overburden or bedrock aquifers under a groundwater discharge permit. During the course of the hydrogeologic study, dissolved arsenic was detected in groundwater samples from the overburden and bedrock at concentrations ranging from 0.009 to 0.24 mg/l. Several samples exceeded the former Reportable Concentration for arsenic of 0.05 mg/l identified in the Massachusetts Contingency Plan (310 CMR 40.0000, the "MCP"), and the Massachusetts Department of Environmental Protection (MassDEP) was notified in accordance with MCP regulations. The MWRA was then required to investigate the nature and extent of arsenic contamination and determine if remediation was required.

2.2 Massachusetts Regulatory Response

Exposure to arsenic in drinking water and/or groundwater is regulated by the MassDEP under two sets of regulations. The drinking water standards are found under the Massachusetts Drinking Water Regulations, 310 CMR 22.00. In January 2006, the Massachusetts Maximum Contaminant Level (MMCL) for arsenic in drinking water was lowered from 0.05 mg/l to 0.010 mg/l, consistent with EPA requirements.

The MCP regulations pertain to releases of oil and/or hazardous materials in the environment and provide requirements for reporting, assessment, and remediation of soil and groundwater. Formal notification to MassDEP is required within a specific time-frame whenever oil or hazardous material (in this case, arsenic) is detected in soil or groundwater above MCP Reportable Concentrations. Once notification has been made to MassDEP, the property owner or responsible party is required to assess the nature and extent of the contamination. Further response actions, potentially including remediation, will be required if contaminant concentrations at the site exceed soil and groundwater cleanup standards, or if concentrations are determined to pose significant risk to human health and the environment.

Currently, the MCP cleanup standard for arsenic is 20 milligrams per kilogram (mg/kg) for all soil categories. For groundwater, the cleanup standards are 0.01 mg/l for settings where groundwater is currently or has the potential to be used as a drinking water resource and 0.9 mg/l for other groundwater uses.

For most MCP-regulated compounds, the soil and groundwater cleanup standards are risk-based and derived using highly conservative exposure assumptions. These cleanup standards are intended to be protective of the most sensitive human health receptors within the general population (i.e., infants, elderly) under unrestricted use conditions. Arsenic is an exception because "background" concentrations in soil and groundwater at many locations are higher than derived risk-based cleanup standards. The MCP defines "background" to include concentrations of contaminants that would exist in the absence of the disposal site which are, "... ubiquitous and consistently present in the environment at and in the vicinity of the disposal site of concern; and attributable to geologic or ecological conditions". Since it is not reasonable or practical to require remediation of sites to below

naturally occurring or background levels, there are provisions in the MCP to achieve a “permanent solution” or site closure if detected concentrations are consistent with background.

In April 2006, the MassDEP amendments to the MCP regulations included a notification exemption for detections of arsenic in soil and groundwater in Worcester County, provided that arsenic detected in soil or groundwater is determined to be consistent with “background” as defined in the MCP. The burden is on the property owner or responsible party to establish site-specific background conditions and demonstrate that arsenic is ubiquitous, consistently present at and in the vicinity of the site, and attributable to geologic conditions. The purpose of this paper is to provide an example of the scientific methodology used to support the position that detected concentrations of arsenic at a site in Worcester County, Massachusetts, met the requirements for designation as “background” under the MCP.

3. RESOLVING THE REPORTABLE CONDITION TO ACHIEVE SITE CLOSURE

3.1 Study Objectives and Approach

The primary objective of this study was to determine whether or not the detected concentrations of arsenic in groundwater at the site could be attributed to background conditions or were due to a historical release from anthropogenic activity. Based on a general knowledge of site history and regional geology for central Massachusetts, the presence of arsenic in groundwater was suspected to be naturally occurring. To confirm this assumption, the following conditions needed to be demonstrated at the site:

1. No past or present anthropogenic sources of arsenic at the site.
2. Soil and/or bedrock at the site contain arsenic-bearing minerals or weathering products.
3. Geochemical parameters in the aquifer are favorable for dissolution of arsenic-bearing minerals and mobilization of arsenic into groundwater.

Each condition by itself would not be adequate to support the assumption that arsenic is naturally occurring. Combined, however, these “lines of evidence” could provide the necessary justification that arsenic concentrations detected in groundwater at the site are the result of naturally occurring, background conditions. For this study, each line of evidence was evaluated, and the findings are discussed below.

4. FIRST LINE OF EVIDENCE: ON-SITE ANTHROPOGENIC SOURCES OF ARSENIC

4.1 Site Description and History

The site consists of approximately five acres of undeveloped, wooded public water supply watershed land located along the southern bank of the Quinapoxet River. As shown in Figure 1, two granite and masonry buildings exist on the site. The building designated “Wachusett Outlet Building” contains the hydroelectric turbine and generator and was built in 1929-1931. The Service Building was constructed during the late-1930s and is currently used for equipment storage. The hydroelectric generating equipment was added to the outlet building in the 1940s.

Historically, the site was part of Oakdale Village, a mill community established sometime between 1815 and 1850. The first mill was built in 1814 for the manufacture of wire fabric and cotton cloth. A sawmill, which was later expanded to include cotton spinning machinery, was built during the

1820s along the Quinapoxet River east of and adjacent to the present-day site. The mills were destroyed by fire in 1853 and later replaced by a larger stone mill complex (Whitcomb, 2002).

Most of Oakdale Village was abandoned and demolished prior to 1897, when construction of the Wachusett Dam and Reservoir began. It is theorized that around that time, a low-permeability subsurface berm was constructed at the site parallel to the riverbank to prevent meandering of the river. The origin of the berm material is unknown but is assumed to be from local sources. This berm is apparent as a topographic ridge in the northwestern margin of the site on Figure 1.

Construction of the MWRA tunnel terminal shaft began in 1926. Based on review of historic photographs, it is believed that at least some of the material used for re-grading portions of the site consisted of rock spoils from tunnel construction activities. Archived construction photographs document that at least some of the soil used for regrading came from off-site locations. There have been no significant on-site changes since construction of the Service Building in the late-1930s and installation of the hydroelectric generating equipment in the 1940s.

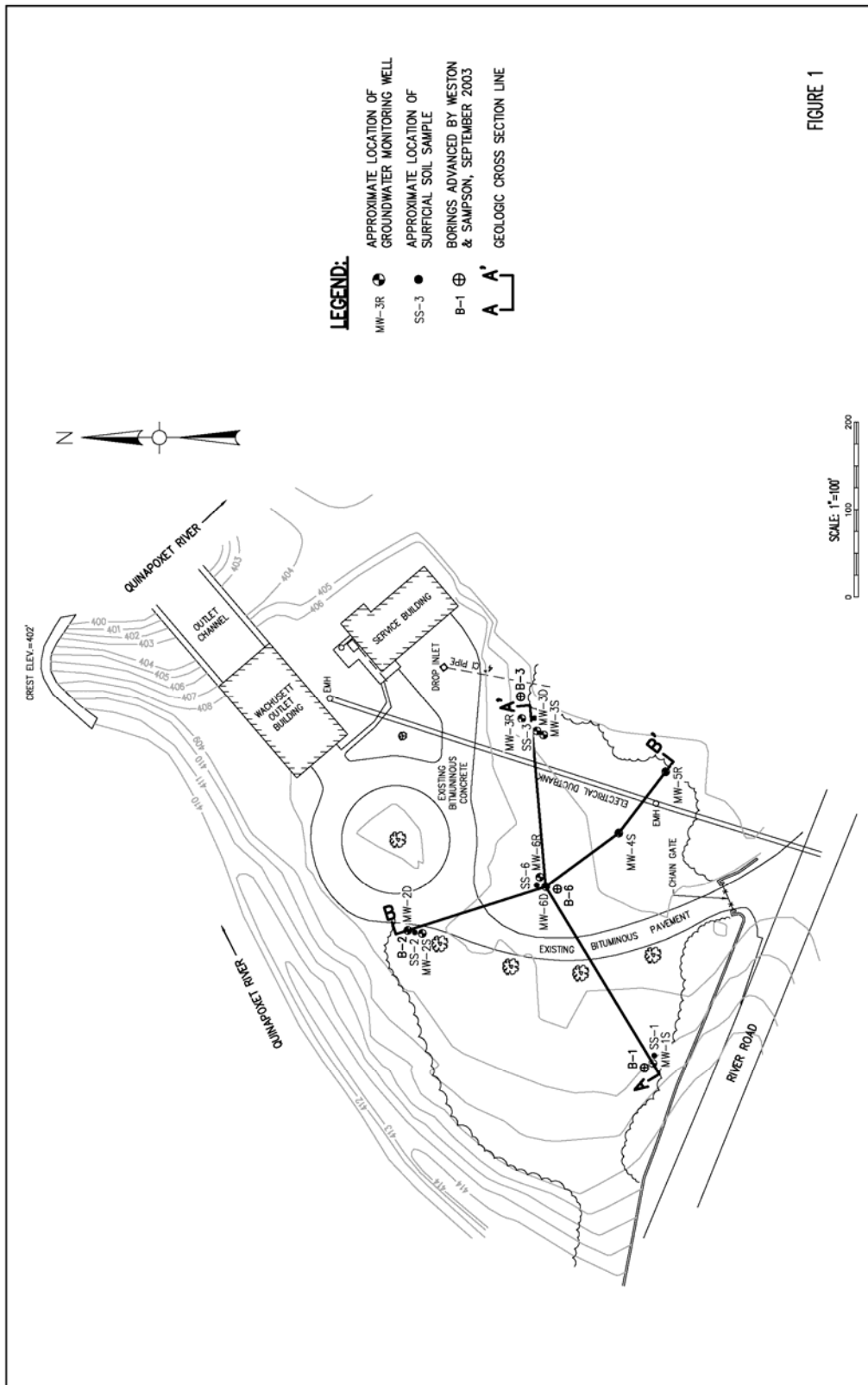

FIGURE 1

Figure 1. Site Plan

4.2 Potential Anthropogenic Sources of Arsenic

Many anthropogenic activities have contributed to arsenic in the environment including combustion of fossil fuels, mining and smelting operations, manufacture and application of pesticides and herbicides, and as an additive to livestock feed (Smedley and Kinniburgh, 2003). Primary industrial uses of arsenic include metallurgy for hardening of copper, lead and alloys, and in the manufacture of glass, insecticides, and wood preservatives (Agency for Toxic Substances and Disease Registry, 2001). In the U.S., the major anthropogenic sources of arsenic in soil over the past century have been attributed to wood preservatives and pesticide applications. Chromated copper arsenate (CCA) has been used since the 1930s to prevent rotting of wood. CCA-treated wood is used predominantly on outdoor decks and structures, and accounts for over 90% of arsenic used today in this country (Welch et al., 2001). CCA-treated wood is not considered a potential source of arsenic at the site because no wooden structures are present.

The other significant man-made source of arsenic is the historical use of pesticides. Lead arsenate, which was first prepared and used in Massachusetts in 1892, was the most widely used pesticide in the country until DDT was manufactured for commercial use in the late 1940s. Its use in New England apple orchards during the first half of the century is well documented (Peryea, 1998; Welch et al., 2000). Although there is no knowledge or records of pesticide use at the site, it cannot be ruled out as a potential source in surficial or shallow soil. According to various studies, however, arsenic released into the environment from pesticide application is relatively immobile and concentrates in the upper 25 centimeters (cm) (0.8 feet) of soil (Peryea, 1998).

As noted above in Section 2.1, arsenic was detected in several monitoring wells at the site. In addition, as is discussed in more detail below in Section 6.2, the highest arsenic concentrations were found in monitoring wells screened in deeper portions of the overburden aquifer, most notably monitoring wells MW-2D and MW-6D (depicted on Figure 1). The presence of arsenic in groundwater from well MW-2D (screened from 16 to 31 feet below grade) or from well MW-6D (screened from 40 to 64 feet below grade), is, therefore, unlikely to be associated with former pesticide application.

In summary, there have been no known anthropogenic sources of arsenic that would account for its presence in groundwater at the site. Former mill industries near the site were not known to have used and/or manufactured arsenic compounds. Arsenic is also not associated with operation of the hydroelectric power station or with waterworks operations, which have been the primary use of the facility for more than 60 and 80 years, respectively. Even if pesticides containing arsenic were used in the past, there would have been little to no impact on groundwater at depths up to 64 feet below grade due to its limited mobility in soil. Based on these findings, the first line of evidence for this study (no on-site anthropogenic sources) was confirmed.

5. SECOND LINE OF EVIDENCE: REGIONAL AND SITE GEOLOGIC CONDITIONS

5.1 General Considerations

The presence of elevated arsenic in groundwater due to weathering of bedrock and overburden containing arsenic-bearing minerals is well documented in various regions of the country, including central Massachusetts (Walsh, 2002; Hon et al., 2002). The second line of evidence to be evaluated at the site was to determine if the soil and/or bedrock geology contained arsenic-bearing minerals, thereby providing a potential source of arsenic to groundwater.

The subsurface geology described below is based on published regional data and sampling results obtained specifically to evaluate the occurrence of arsenic in groundwater at the subject site. For this investigation, soil samples were collected and analyzed for arsenic, related metals, and various geochemical parameters. Bedrock samples were not collected or analyzed, since the bedrock wells had already been installed prior to initiation of the arsenic investigation and because the focus of the

prior study was on hydrogeologic aquifer characteristics, rather than chemical properties. However, significant data exist on the chemical composition of bedrock in the region, and the natural overburden materials at the site, which are of glacial origin, are likely derived from regional bedrock.

5.2 Bedrock Geology

5.2.1 Regional Bedrock Geology

The USGS bedrock geology map for the Nashua River drainage basin identifies bedrock underlying the site and surrounding region as igneous and metasedimentary from the Paleozoic and Precambrian eras. Edward Grew, a doctoral candidate from Harvard University, mapped the bedrock in the vicinity of the site as the Oakdale Formation, a geographically widespread heterogeneous grouping of metasiltstone with phyllite, calcareous quartzite, calcareous siltstone, and minor schist. He described the Oakdale Formation in this area as “fine grained, purple-gray to gray biotite schist and granulite and green-gray to gray calc-silicate granulite” (a.k.a. quartzite). Trace amounts of pyrite were observed in some of the thin sections prepared from hand samples collected from this area of the Oakdale Formation. The Oakdale formation locally contains beds of carbonaceous or sulfidic mica schist or phyllite. Arsenic is often seen in sulfide minerals, typically substituting for iron (for instance, in minerals such as pyrite), and as arsenopyrite (Grew, 1970).

In 1992 the MWRA geologist David Ashenden produced a comprehensive geological report of the Wachusett Reservoir area. In his report, Ashenden retained the “Oakdale Formation” terminology used by Grew for the rocks in the Oakdale area, rather than the Littleton Formation, which is used in the Bedrock Geological Map of Massachusetts (Zen, 1983). Ashenden considered the rock exposed in the Quinapoxet River adjacent to the site and on a nearby hillside as the type location for the subdivision of the Oakdale that he called “Oakdale west of the Wekepeke Fault,” a regional fault located approximately 1,500 feet east of the site. He described these rocks as “gray, thinly laminated to poorly foliated, fine-grained, biotite quartzite”. Ashenden examined the hand samples collected from beneath the site during shaft and tunnel construction, and most significantly, found that some of the samples had small sulfide mineral grains (Ashenden, 1992).

5.2.2 Site-Specific Bedrock Geology

During the initial hydrogeological study described in Section 2.1, three bedrock wells (MW-3R, MW-5R and MW-6R) were drilled to depths ranging from 220 to 245 feet below grade. The depth to bedrock at these locations ranged from 45 to 65 feet below grade.

The bedrock was highly weathered in the top 8 feet. Fracture zones were observed in all bedrock borings, the most numerous of which were found in the borehole for well MW-6R at multiple depths below grade (\approx 80-105 feet, \approx 116-119 feet, \approx 131-133 feet and \approx 155 feet). The rock was described as a fine-grained, alternating reddish-brown and dark green quartz mica phyllite with quartz veins. Using the formation terminology from The Bedrock Geological Map of Massachusetts, the bedrock was ultimately identified as being representative of the Littleton Formation based on ease of drilling and mineralogy of the bedrock cuttings from the borehole. The Littleton Formation consists of interbedded gray to dark-gray biotite-muscovite-quartz schist and gray quartzite (Zen, 1983).

As noted above, hand samples collected from beneath the site were found to contain small sulfide mineral grains (Ashenden, 1992). Therefore, based on observations of bedrock from the site and regional geologic information, it is reasonable to conclude that bedrock beneath the site contains arsenic-bearing minerals.

5.3 Overburden Geology

5.3.1 Regional Overburden Geology

Geological mapping of the Quinapoxet Valley during the design of the Quabbin Aqueduct in the late 1920s interpreted the surficial deposits in the eastern end of the aqueduct to be modified glacial drift including morainal, glacial lake deposits, and outwash sands and gravels. In the immediate vicinity of the site, these were more specifically identified as glacial moraine deposits (Ashenden, 1992).

The amount of published regional data for overburden is more limited than that found for bedrock. In a soil study conducted by Hon et al. (2002) elevated concentrations of arsenic (20 to 800 mg/kg) were found in sections of overburden within a zone transversing N-S across central Massachusetts.

5.3.2 Site-Specific Overburden Geology

Seven monitoring wells screened in the overburden aquifer were installed during the hydrogeological investigation (locations are shown on Figure 1). Table 1 summarizes the construction details of overburden and bedrock monitoring wells.

Table 1. Monitoring well construction details

| Well ID | Screened Interval (feet below ground surface) | General Lithology in Screened Interval |
|----------------|--|---|
| MW-1S | 5 – 20 | Sand/Gravel and Silt/Clay Combination |
| MW-2S | 4.5 – 19.5 | Sand/Gravel and Silt/Clay Combination |
| MW-2D | 16.5 – 31.5 | Silt/Clay |
| MW-3S | 4.5 – 19.5 | Sand/Gravel |
| MW-3D | 24.5 – 34.5 | Sand/Gravel and Silt/Clay Combination |
| MW-3R | 55 – 255 ^a | Bedrock |
| MW-4S | 5 – 20 | Sand/Gravel |
| MW-5R | 75 – 275 ^a | Bedrock |
| MW-6D | 40 – 64 | Silt/Clay |
| MW-6R | 71.5 – 275 ^a | Bedrock |

^a The indicated screened interval for the bedrock wells represents the open-hole interval.

Generalized geologic cross-sections are shown in Figure 2. The uppermost unit across most of the site appears to be an artificial fill material that is likely associated with re-grading of the site during various phases of its development. This fill material generally consists of fine- to medium-grained sand with some pebbles and cobbles. Native unconsolidated materials consisting of sand/gravel deposits ranging in thickness from approximately 10 to 35 feet were observed underlying the fill unit across the site, increasing in thickness from west to east, as shown in cross-section A-A'. As shown in cross-section B-B' (north-south), the sand/gravel unit is thickest at location MW-6D/6R.

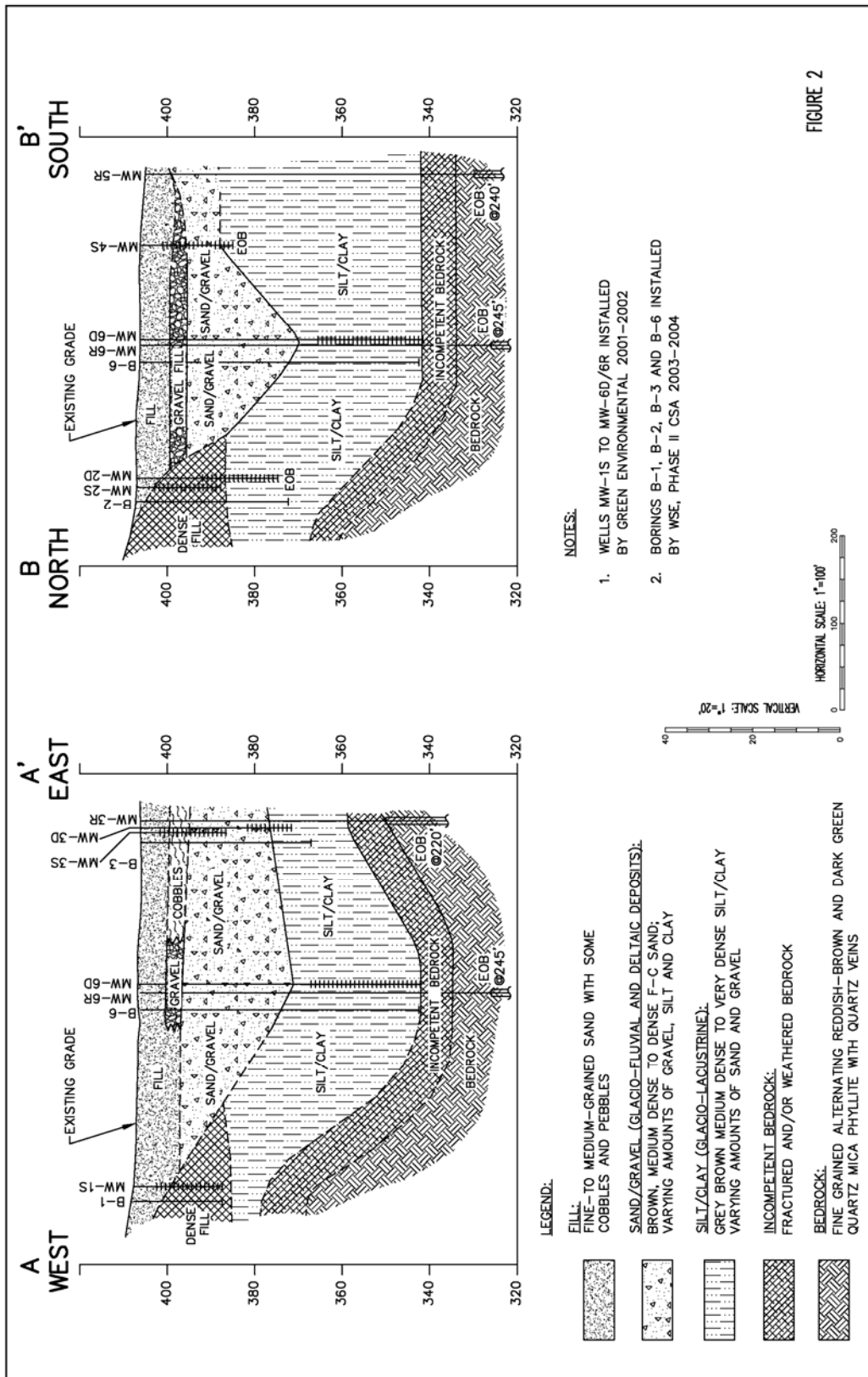

Figure 2. Geological Cross Sections: A-A' and B-B'

The native deposits consist of dense silty sand in the vicinity of well MW-1S and sand and gravel of presumably glaciofluvial/glaciolacustrine origin on the eastern portion of the site in the vicinity of groundwater monitoring wells MW-4S and MW-3S. This distribution is consistent with the regional topography and with information provided on the surficial geologic map, which indicates the presence of glacially derived sand and gravel in the vicinity of stream valleys in the region. The silt/clay layer underlying the sand/gravel unit ranges in thickness from approximately 20 to 50 feet. The dense silt encountered in the vicinity of the MW-2 well cluster appeared “non-native” and was likely placed as part of dam construction to prevent future lateral meandering of the Quinapoxet River.

5.4 Arsenic Concentrations in Overburden

A total of 35 soil samples from four borings were collected during drilling at the study site and submitted for laboratory analyses for arsenic, iron, and manganese. Table 2 summarizes the results of the laboratory analysis and includes the generalized stratigraphic interval from which each sample was collected. The cross-sections in Figure 2 contain more detailed descriptions of the stratigraphy comprising each generalized stratigraphic interval.

Most of the soil samples (29 of 36) contained arsenic at concentrations less than the MCP cleanup standard and “background” concentration of 20 mg/kg. The highest arsenic concentration (115 mg/kg) was detected at 8 to 10 feet in boring MW-1S. Most of the samples in this boring up to a depth of 16 feet below grade contained concentrations above 20 mg/kg. The concentrations in all other borings were below 20 mg/kg, except for samples collected from 0 to 3 feet in boring MW-2D, which ranged from 27 to 32 mg/kg. In general, the laboratory data also indicated that higher arsenic concentrations were found in samples that also contained higher iron and manganese concentrations, which would not occur if arsenic were attributed to anthropogenic sources.

Table 2. Soil analytical results

| Boring | Sample Depth (ft.) | Arsenic (mg/kg) | Iron (mg/kg) | Mn ^a (mg/kg) | Stratigraphic Interval |
|--------|--------------------|-----------------|--------------|-------------------------|------------------------|
| MW-1S | 0 – 1 | 23 | --- | --- | Sand/Gravel |
| | 0 – 3 | 47 | 16 | 21 | Sand/Gravel |
| | 6 – 8 | 16 | 26 | 40 | Sand/Gravel |
| | 8 – 10 | 115 | 49 | 41 | Sand/Gravel |
| | 10 – 12 | 27 | 18 | 24 | Silt/Clay |
| | 12 – 14 | 16 | 18 | 18 | Silt/Clay |
| | 14 – 16 | 22 | 20 | 20 | Silt/Clay |
| | 18 – 20 | 7 | 18 | 20 | Silt/Clay |
| | 20 – 22 | 11 | --- | --- | Silt/Clay |
| | DUP | 8 | 23 | 31 | Silt/Clay |
| | <i>Mean</i> | 29 | 23 | 27 | |
| MW-2D | 0 - 1 | 27 | --- | --- | Sand/Gravel |
| | 0 – 3 | 32 | 19 | 26 | Sand/Gravel |
| | 17 – 19 | 17 | 18 | 25 | Silt/Clay |
| | 19 – 21 | 14 | 18 | 24 | Silt/Clay |
| | 21 – 23 | 10 | 17 | 22 | Silt/Clay |
| | 23 – 25 | 5 | 11 | 15 | Silt/Clay |
| | 25 – 27 | 7 | 14 | 16 | Silt/Clay |
| | 27 – 29 | 6 | 13 | 15 | Silt/Clay |
| | 29 – 31 | 7 | 18 | 19 | Silt/Clay |
| | 31 – 33 | 7 | 16 | 16 | Silt/Clay |
| | <i>Mean</i> | 13 | 16 | 20 | |
| MW-3D | 0 – 1 | 16 | --- | --- | Sand/Gravel |
| | 0 – 3 | 10 | 7 | 11 | Sand/Gravel |
| | 24 – 26 | 7 | 9 | 10 | Sand/Gravel |
| | 26 – 28 | 9 | 13 | 15 | Sand/Gravel |
| | 28 – 30 | 5 | 11 | 15 | Silt/Clay |
| | 30 – 32 | 5 | 12 | 13 | Silt/Clay |
| | 32 – 34 | 11 | 24 | 33 | Silt/Clay |
| | 38 – 40 | --- | --- | --- | Silt/Clay |

| Boring | Sample Depth (ft.) | Arsenic (mg/kg) | Iron (mg/kg) | Mn ^a (mg/kg) | Stratigraphic Interval |
|--------|--------------------|-----------------|--------------|-------------------------|------------------------|
| | <i>Mean</i> | 9 | 13 | 16 | |
| MW-6D | 0 – 1 | 11 | --- | --- | Sand/Gravel |
| | 0 – 3 | 13 | 9 | 15 | Sand/Gravel |
| | 39 – 41 | 17 | 27 | 46 | Silt/Clay |
| | 43 – 45 | 9 | 26 | 40 | Silt/Clay |
| | 47 – 49 | 7 | 25 | 35 | Silt/Clay |
| | 53 – 55 | 6 | 21 | 33 | Silt/Clay |
| | 59 – 61 | 8 | 32 | 68 | Silt/Clay |
| | DUP | 15 | --- | --- | Silt/Clay |
| | 61 – 63 | 8 | 27 | 37 | Silt/Clay |
| | <i>Mean</i> | 10 | 24 | 39 | |

^a Manganese

The depths noted in bold typeface indicate samples selected for electron microprobe analysis.

Eleven of the above soil samples, highlighted in bold in Table 2, were submitted to the Electron Microprobe and Scanning Electron Microscope Facility of the Department of Geosciences of the University of Massachusetts at Amherst to identify the presence of arsenic-bearing minerals in the samples. The samples selected for microprobe analysis were from depths within the screened intervals of the corresponding monitoring wells. Arsenic was detected in 4 of 11 samples. Table 3 summarizes the chemical composition of each arsenic-bearing sample and associated mineralogy:

Table 3. Arsenic mineralogy and chemical composition

| Boring | Sample Depth (ft.) | Composition |
|--------|--------------------|---|
| MW-1 | 8 – 10 | Poorly crystalline, hydrous alteration products often associated with biotite; and iron-rich clinosafflorite [(Co,Fe,Ni)As ₂] |
| MW-1 | 10 – 12 | altered iron oxides |
| MW-3 | 24 – 26 | iron-rich clinosafflorite [(Co,Fe,Ni)As ₂] |
| MW-3 | 32 – 34 | Arsenopyrite (FeAsS) |

The mineralogy results confirmed the presence of arsenic-bearing minerals and weathering products in soil. Clinosafflorite was identified in samples from borings MW-1 (8 to 10 feet) and MW-3 (24 to 26 feet). Of the minerals identified, this cobalt-bearing mineral has the highest weight percent of arsenic (> 70%) (Jercinovic, 2004). This finding is similar to that reported by Hon et al. (2002), which indicated that the highest arsenic concentrations were detected in soil containing cobalt. The soil study conducted by Hon et al. found elevated concentrations of arsenic (20 to 800 mg/kg) in sections of overburden within a zone traversing north-south across central Massachusetts. Bedrock underlying these areas of elevated arsenic concentrations contained cobaltites (30 to 50% by weight arsenic) and pyrites.

It must be noted that there is no correlation in arsenic concentrations between the soil laboratory results and microprobe analysis. As concluded in the UMass report, "...it can be stated with certainty that arsenic occurs within solid phases within these four samples", however, "... it cannot be concluded that arsenic does not occur in the others, only that mapping of the exposed cross section did not reveal any" (Jercinovic, 2004). This apparent discrepancy is related to the differing analytical methods between electron microprobe analysis and standard bulk laboratory analysis. Electron microprobe analysis analyzes the two-dimensional surface of a prepared sample rather than the entire digested bulk sample in traditional laboratory analysis.

In summary, subsurface samples of unconsolidated deposits at the site contained arsenic-bearing minerals and elevated concentrations of arsenic. Although bedrock was not sampled, descriptions of bedrock, as observed in subsurface samples from the site, are consistent with published regional data indicating elevated arsenic levels in rock. The second line of evidence required to demonstrate that arsenic is naturally occurring at the site was therefore established.

6. THIRD LINE OF EVIDENCE: GEOCHEMICAL CONDITIONS

6.1 General Arsenic Geochemistry

The fact that arsenic-bearing minerals are present in soil and bedrock does not by itself indicate that arsenic will be present in groundwater. The third and final line of evidence that observed concentrations of arsenic in groundwater are naturally occurring required a demonstration that the geochemical conditions in the aquifer were conducive to mobilization of arsenic. The dissolution of arsenic from soil and/or bedrock into groundwater is highly dependent on geochemical conditions in the aquifer. Most arsenic in groundwater occurs in one of two oxidation states, arsenate [As(V)] or arsenite [As(III)]. Arsenite is more mobile and is the predominant species under reducing conditions (low dissolved oxygen and oxidation-reduction potential (ORP)) and at $\text{pH} < 9.0$ (Blum and Renshaw, 2003).

Arsenic is strongly adsorbed by clay minerals and hydroxides of iron, aluminum and calcium, which coat clay particles. The soil adsorption capacity is influenced by pH and ORP, both of which affect the net charge of the hydroxide ion and the oxidation state of arsenic (Welch et al., 2000; Blum and Renshaw, 2003). When arsenic associated with iron oxides and sulfide minerals such as arsenopyrite dissolves under near-neutral pH conditions, iron forms an oxyhydroxide solid, and arsenic becomes a negatively charged ion. Under neutral and low pH conditions, iron particles have a positive charge and bind with arsenic, resulting in decreased concentrations of arsenic in groundwater. As the pH increases, iron hydroxide colloids become negatively charged and repel arsenic, resulting in its mobilization. The iron hydroxide particle remains insoluble and, unlike conditions in soil, there is less correlation between iron and arsenic concentrations in groundwater (Blum and Renshaw, 2003).

6.2 Site-Specific Geochemistry

The arsenic mobilization model described above was evaluated as part of this study by measuring geochemical parameters pH, ORP, and dissolved oxygen each time groundwater was sampled for arsenic. Between October 2001 and August 2004, eight rounds of groundwater sampling were conducted on some or all of the ten monitoring wells. The final four rounds of sampling included the entire set of wells. Measured parameters included the above field parameters, as well as dissolved arsenic, iron, and manganese.

Groundwater from monitoring wells screened entirely in the upper sand/gravel unit did not contain arsenic above method detection limits (MDLs). Groundwater from wells screened across both the upper sand/gravel and the lower silt/clay units contained arsenic at concentrations ranging from below MDLs to 0.027 mg/l. Groundwater from wells screened in just the lower silt/clay unit contained the highest detected concentrations of arsenic, up to 0.082 mg/l. Except for well MW-5R, lower concentrations were detected in groundwater from the bedrock wells. Table 4 summarizes the average sampling results for each well. The values included in the table are the averages from four rounds of sampling: February 2003, November 2003, April 2004, and August 2004. The table is arranged in order of stratigraphic interval.

The highest average arsenic concentrations, ranging from 0.032 mg/l to 0.082 mg/l, were detected in groundwater from monitoring wells MW-2D, MW-6D, and MW-5R. The geochemical conditions measured in these wells were:

- pH between 7 and 8
- low dissolved oxygen (<1.2 mg/L)
- relatively low ORP (i.e., reducing conditions)

Table 4. Average groundwater concentrations and measurements: Feb. 2003 – Aug. 2004

| Well ID | Screened Interval ^a | Sample Depth (ft.) ^b | PH (SU) | DO ^c (mg/l) | ORP ^d (mV) | Arsenic (mg/l) | Iron (mg/l) | Mn ^e (mg/l) |
|---------|--------------------------------|---------------------------------|------------|------------------------|-----------------------|------------------|-------------|------------------------|
| MW-3S | Sand/ | 14 | 5.0 | 8.0 | 218 | <0.004 | 0.02 | 0.01 |
| MW-4S | Gravel | 14 | 4.7 | 7.3 | 313 | <0.004 | 0.03 | 0.03 |
| | <i>Mean</i> | | 4.9 | 7.7 | 266 | <0.004 | 0.03 | 0.02 |
| MW-1S | Sand/ | 7–8 | 5.0 | 3.9 | 114 | 0.01 | 0.10 | 0.13 |
| | Gravel | 12 | 5.8 | 0.6 | 157 | 0.02 | --- | --- |
| | and Silt/Clay | 19 | 5.3 | 3.5 | 70 | 0.02 | 0.65 | 0.24 |
| MW-2S | | 11–12 | 6.3 | 5.0 | 101 | <0.004 | <0.025 | 0.01 |
| | | 19 | 6.1 | 5.0 | 121 | <0.004 | 0.01 | 0.01 |
| MW-3D | | 25 | 5.5 | 4.0 | 243 | 0.01 | 0.04 | 0.11 |
| | | 30 | 5.7 | 5.7 | 261 | <0.004 | --- | --- |
| | | 34 | 5.7 | 3.0 | 216 | 0.02 | 0.12 | 0.17 |
| | <i>Mean</i> | | 5.7 | 3.8 | 160 | 0.001 | 0.16 | 0.11 |
| MW-2D | Silt/Clay | 18 | 7.3 | 1.1 | 14 | 0.08 | 0.07 | 0.27 |
| | | 24 | 7.2 | 0.3 | 57 | 0.07 | --- | --- |
| | | 30 | 7.2 | 1.2 | 12 | 0.06 | 0.05 | 0.23 |
| MW-6D | | 42 | 7.7 | 0.5 | 91 | 0.05 | 0.30 | 0.06 |
| | | 52 | 7.4 | 0.1 | -27 | 0.03 | --- | --- |
| | | 62 | 7.6 | 0.5 | 29 | 0.05 | 0.34 | 0.07 |
| | <i>Mean</i> | | 7.4 | 0.6 | 29 | 0.06 | 0.19 | 0.16 |
| MW-3R | Bedrock | 140-170 | 8.6 | 1.7 | 141 | 0.03 | 0.08 | 0.03 |
| MW-5R | | 150-240 | 7.8 | 0.7 | -30 | 0.08 | 0.31 | 0.15 |
| MW-6R | | 165-180 | 8.9 | 1.0 | 21 | 0.03 | 0.03 | 0.02 |
| | <i>Mean</i> | | 8.4 | 1.1 | 44 | 0.05 | 0.14 | 0.07 |

^a The overburden stratigraphic unit(s) across which the well screen is placed. Bedrock wells are open-hole construction and are cased from the ground surface to the top of competent bedrock.

^b Sample depth is the depth at which the groundwater sample was collected using low-flow sampling techniques.

^c Dissolved oxygen

^d Oxidation reduction potential

^e Manganese

Groundwater from two bedrock wells, MW-3R and MW-6R, contained slightly lower arsenic concentrations (0.03 mg/l), but exhibited higher pH values (8.6 to 8.9). The slightly lower arsenic concentrations may be due to the change in oxidation state from arsenite to the less mobile arsenate, which occurs at pH above 9.0. Groundwater from one bedrock well, MW-5, with an average concentration of 0.08 mg/l, contained higher concentrations than groundwater from the other two bedrock wells. This is likely due to the lower pH than that observed at the other bedrock wells, as well as to lower dissolved oxygen and very low ORP values, conditions that are favorable for the mobilization of arsenic.

Lower arsenic concentrations were detected in groundwater from overburden wells MW-1S, MW-2S, MW-3S, MW-3D, and MW-4S. The pH measurements for groundwater from these wells were all below 6.3, and ranged down to a pH of 4.7. Dissolved oxygen and ORP were also higher than in other wells.

The geochemical characteristics observed in groundwater indicate that the geochemical environment in the sand/gravel, and sand/gravel and silt/clay units is acidic, oxygenated, and oxidizing, as opposed to the slightly basic, low dissolved oxygen, and more reducing conditions found deeper in the silt/clay unit. As a result, the geochemical environment found in the silt/clay unit is more favorable for the dissolution of arsenic from mineral grains into the groundwater.

Although there is no apparent correlation between arsenic concentrations in soil, aquifer lithology, and arsenic concentrations in groundwater, that lack of correlation can be explained by the heterogeneous nature of arsenic distribution in the unconsolidated deposits and the fact that groundwater samples are representative of a larger volume of aquifer than can be represented by a given soil sample collected from a similar depth. Particularly relevant to the overall evaluation of the data is the fact that the silt/clay unit contains more mineral surface area per unit of aquifer (more and smaller grains), thus exposing more mineral surface for possible dissolution of arsenic-bearing

minerals. Coupled with the lower rate of groundwater flow, which likely limits introduction of oxygen into the aquifer, it is not surprising that arsenic concentrations are higher in groundwater from the silt/clay unit than in the more permeable sand/gravel deposits.

Overall, the highest arsenic concentrations in groundwater at the site were detected in wells exhibiting a range of geochemical parameters consistent with those considered favorable for arsenic mobilization. Arsenic was also detected in some groundwater samples exhibiting one or more geochemical parameters outside the optimal range, which is to be expected in any data set and does not preclude the evidence supporting the presence of naturally occurring arsenic at the site. The favorable geochemical conditions in groundwater for the mobilization of arsenic therefore confirm the third and final line of evidence required to support the hypothesis that detected concentrations of arsenic in groundwater at the site are naturally occurring.

7. CONCLUSIONS¹

The results of this study strongly indicated that arsenic detected in groundwater at the site can be attributed to naturally occurring geologic conditions and is not the result of anthropogenic activities. This conclusion is based on the following lines of evidence:

1. No anthropogenic sources of arsenic were identified, either historically or under current use conditions.
2. Arsenic was detected in bulk chemical analysis, and arsenic-bearing minerals are present in overburden materials that were derived from local bedrock. Local mapping of bedrock and the type of bedrock observed during drilling of bedrock wells at the site is consistent with rock types known to contain high concentrations of arsenic, and observations of bedrock samples from the on-site shaft and tunnel indicated the presence of small sulfide mineral grains.
3. The geochemical conditions favoring mobilization of arsenic from geologic materials into groundwater were reported in groundwater from wells installed in both overburden and bedrock at the site.

As a result of these findings, site closure under the MCP was achieved, and no further investigatory or remedial actions were necessary.

REFERENCES

- Agency for Toxic Substances and Disease Registry. 2001. Toxicological Profile for Arsenic. www.atsdr.cdc.gov/toxprofiles/. Updated May 25, 2001.
- Ashenden, D.S. 1992. Geology of the Wachusett Reservoir Area, Central Massachusetts with Specific References to the Wachusett Bypass Options. Massachusetts Water Resources Authority, Waterworks Division.
- Ayotte, J.D., Montgomery, D.L., Flanagan, S.M., and Robinson, K.M. 2003. Arsenic in Groundwater in Eastern New England: Occurrence, Controls, and Human Health Implications. *Environ. Sci. Technol.* 37, 2075-2083.
- Ayotte, J.D., Nolan, B.T., Nuckols, J.R., Cantor, K.P., Robinson, Jr., G.R., Baris, D., Hayes, L., Karagas, M., Bress, W., Silverman, D.T., and Lubin, J.H. 2006. Modeling the Probability of Arsenic in Groundwater in New England as a Tool for Exposure Assessment. *Environ. Sci. Technol.* 40, 3578-3585.
- Blum, J.D. and Renshaw, C.E., 2003. Sources, transport and fate of Arsenic in Groundwater. Dartmouth Toxic Metals Research Program, Center for Environmental Health Sciences at Dartmouth. <http://www.dartmouth.edu/~toxmetal/RSCRgw.shtml>.
- Grew, E.S. 1970. Geology of the Pennsylvanian and Pre-Pennsylvanian Rocks of the Worcester Area, Massachusetts. Doctoral Thesis, Harvard University.
- Hon, R., Doherty, K., and Davidson, T. 2002. Arsenic Sources and Pathways in the Overburden of Central Massachusetts. Abstract from Arsenic in New England Conference. <http://www.dartmouth.edu/%7Ecehs/ArsenicConference/Hon.html>.

¹ This article represents the opinions and (legal) conclusions of the author(s) and not necessarily those of the MWRA.

- Jercinovic, M.J. 2004. MWRA Arsenic Survey – Oakdale Power Station: Electron Microprobe Results. Final Report, March 3, 2004.
- Peryea, F.J. 1998. Historical Use of Lead Arsenate Insecticides, Resulting Soil Contamination and Implications for Soil Remediation. Washington State University. <http://soils.tfrec.wsu.edu/leadhistory.htm>.
- Ravenscroft, P., McArthur, J.M. and Hoque, B.A. 2001. Geochemical and Palaeohydrological Controls on Pollution of Groundwater by Arsenic. In: Arsenic Exposure and Health Effects IV, pp. 1-19. Chappell, W.R., Abernathy, C.O., and Caldron, R. (Eds.). Oxford, Elsevier Science Ltd.
- Smedley, P.L. and Kinniburgh, D.G. 2003. Source and Behavior of Arsenic in Natural Waters. In: United Nations Synthesis Report on Arsenic in Drinking Water, Chapter 1, pp. 1-61. http://www.who.int/water_sanitation_health/dwq/arsenicun1.pdf.
- Walsh, G.J. 2002. Bedrock Geology in the vicinity of the Leicester Well Site, Paxton, Massachusetts. USGS, Open File Report 02-433. <http://pubs.usgs.gov/of/2002/of02-433/>.
- Welch, A.H., Westjohn, D.B., Helsel, D.R., and Wanty, R.B. 2000. Arsenic in Ground Water of the United States: Occurrence and Geochemistry. *Ground Water* 38: 4, 589-604.
- Welch, A.H., Ryker, S., Helsel, D., and Hamilton, P. 2001. Arsenic in Groundwater of the United States: An Overview. *Water Well Journal*, February 2001, 30–33.
- Whitcomb, Edgar A., 2002. A Story of Oakdale, West Boylston Historical Society. West Boylston, Massachusetts.
- Zen, E-An (Ed.). 1983. Bedrock Geologic Map of Massachusetts. United States Geological Survey.

Chapter 7

RISK AND BACKGROUND EVALUATION FOR ARSENIC IN SOIL AT A PLANNED RESIDENTIAL DEVELOPMENT

Christopher M. Teaf^{1,2}, Douglas J. Covert¹, R. Marie Coleman¹, Michael Petrovich³, R.S. Murali⁴ and Vince Yarina⁴

¹Hazardous Substance & Waste Management Research, Inc., 2976 Wellington Circle West, Tallahassee, FL 32309;

²Center for Biomedical & Toxicological Research, Florida State University, 2035 E. Dirac Dr., Tallahassee, FL 32310;

³Hopping Green & Sams, P.A., 123 S. Calhoun Street, Tallahassee, FL 32301; ⁴Langan Engineering, 7900 Miami Lakes Drive Suite 102, Miami, FL 33016

Abstract: Arsenic soil concentrations at many environmental investigation sites in Florida and other states have been reported above the current U.S. Environmental Protection Agency (EPA) soil screening level (0.4 mg/kg) and above the recently modified (2005) Florida default residential exposure Soil Cleanup Target Level (SCTL) of 2.1 mg/kg. At a site in west central Florida, arsenic soil concentrations were compiled site-wide during early routine sampling. In a state-specific 2001 study of background concentrations of arsenic in Florida soils, 27 out of the 51 counties that were evaluated contained arsenic soil concentrations above the EPA soil screening level. Ten out of the 51 counties that were evaluated had arsenic concentrations in soil regularly above the then-applicable residential exposure SCTL of 0.8 mg/kg. That study also identified elevated arsenic concentrations above FDEP's residential exposure SCTL in a geographic "belt" from Leon and Madison counties in NW Florida to Lee and Charlotte counties in SW Florida. This belt includes Hillsborough County, in which the Site is located. Based on a very extensive site database for surface and subsurface soil, it was concluded that the observed arsenic concentrations at the Site represent a naturally occurring condition (2.4 mg/kg mean and 2.8 mg/kg 95% UCL drawn from over 2,000 site soil samples). The close agreement between the mean and the 95% UCL concentrations indicates a low degree of statistical variability across the Site, and is supportive of the conclusion that the observed distribution represents naturally occurring background. Further, while the 2.8 mg/kg UCL exceeds the Florida default residential cleanup target of 2.1 mg/kg, it does not represent a significantly increased human health risk (1.3×10^{-6} excess lifetime cancer risk). While there was no regulatory involvement, preparation of the initial background survey, a site risk evaluation, and evaluations of local background arsenic concentrations allowed the Site owner and prospective developer to determine that the 340 acre site was suitable for residential improvement.

Key words: Arsenic, soil, background, risk assessment, planned residential development

1. INTRODUCTION

The project site (the Site) is a proposed residential development of no more than 500 units, with associated infrastructure, and is comprised of approximately 340 acres consisting of pasture land, agricultural land, undeveloped land, and low-lying wetland areas in Hillsborough County, Florida. Arsenic was present in soil at concentrations that exceeded the then-existing Florida Department of Environmental Protection (FDEP) Soil Cleanup Target Level (SCTL) of 0.8 mg/kg established for default residential, direct exposure scenarios (residential exposure). This FDEP SCTL for arsenic typically is applied to sites contaminated from a prohibited discharge of pollutants or hazardous substances. Originally, it was thought that the arsenic concentrations in the soil were localized in and around a small former sprayfield centrally located on the property. Thus, the FDEP SCTL was deemed an appropriate point-of-comparison. Subsequently, extensive characterization of the property, historical evaluation, and an in depth literature review, lead to the conclusion that the soil

concentrations at the property were naturally occurring. Therefore, the 0.8 mg/kg FDEP SCTL was considered not to be applicable in a regulatory framework, but was deemed useful as a guideline in the context of the property's development. In the interim, during the several-month investigation process, the 0.8 mg/kg SCTL value was revised by FDEP to 2.1 mg/kg, based upon more recent toxicological information regarding oral relative bioavailability of arsenic in Florida-specific soils (FDEP, 2005).

The initial intention of the property owner/developer and consultant group was to demonstrate, through a detailed soil management plan and an extensive characterization effort that the site-wide concentrations were below the 2.1 mg/kg unrestricted use SCTL. This would satisfy, by definition, any perceived environmental health concerns of the prospective developers, financial institutions and eventual residents/owners. After months of sampling and statistical assessments which revealed site-wide concentrations that were similar to, but slightly above the target concentration, it was decided to more formally support the position that the observed arsenic concentrations were the result of a naturally occurring background condition.

2. MATERIALS AND METHODS

A Phase I Environmental Site Assessment (ESA) originally was performed on the Site in October 1998. The Phase I ESA identified 11 potential areas exhibiting "recognized environmental conditions". Based on the Phase I ESA information, a limited Phase II ESA was conducted in July 1999. This investigation included the collection of soil and groundwater samples in the 11 locations that previously were identified. Arsenic concentrations in groundwater ranged from 1.19 to 21.9 micrograms per liter, below the contemporary regulatory limit of 50 micrograms per liter. In addition, soil arsenic concentrations in 9 locations at the property, primarily within the area of a former domestic sprayfield, were above the residential exposure SCTL of 0.8 mg/kg by a small margin. However, no soil concentrations exceeded the leachability-based SCTL of 29 mg/kg, so groundwater was not further investigated.

Following the Phase I and Phase II investigations, four additional characterization efforts were undertaken during the next few years to determine the nature and extent of the arsenic present in surface and subsurface soil. A total of 272 samples were collected and analyzed for total arsenic, focused primarily in and around the former sprayfield area of the Site.

In mid-2004, a Soil Management Plan (SMP) was developed for the Site in order to guide earth movement and soil sampling operations during development. The preliminary soil sampling efforts described above, those previous to July 2004, are termed "pre-SMP" efforts, while those occurring after this time are termed "post-SMP".

In addition to the 272 pre-SMP samples described above, approximately 1,800 soil samples were collected during post-SMP activities. By this time, it was clear that the former sprayfield was not an isolated area of increased arsenic concentrations. Thus, the post-SMP characterization efforts were conducted on a more site-wide basis, primarily from soil stockpiles that were assembled in anticipation of use on-site. Eighty-eight stockpiles, each composed of approximately 5,000 cubic yards of soil, were derived from excavation of planned on-site ponds or from consolidation of existing surface soils. Twenty random samples were collected from each pile and analyzed for total arsenic. Following confirmation that the soils were below 2.1 mg/kg, the soil from these stockpiles was to be redistributed on-site for use as residential lot fill material.

3. RESULTS

Summary statistics, as developed using the Florida UCL statistical analysis tool (FDEP, 2004a), for Pre-SMP soil samples that were collected from 0 to 2 feet below land surface (BLS) and analyzed for total arsenic are summarized in the table below. (Table 1)

Table 1.

| | Frequency of Detection | Mean Detected Concentration (mg/kg) | 95% UCL of the Mean Concentration (mg/kg) | Maximum Detected Concentration (mg/kg) |
|--|------------------------|-------------------------------------|---|--|
| Arsenic in soil 0 to 2 feet bls | 48 of 68 | 1.2 | 1.8 | 6.2 |

The mean and 95% UCL of the mean concentrations are based on the non-parametric Chebyshev test because the data set is neither normally distributed nor lognormally distributed (FDEP, 2004a).

Arsenic was detected above the reported detection limit in 48 of 68 surface soil samples with a mean detected concentration of 1.2 mg/kg. The non-parametric 95% upper confidence limit (UCL) of the mean concentration for the 0-2 foot pre-SMP soils was 1.8 mg/kg, with a maximum concentration of 6.2 mg/kg. The 95% UCL represents a conservative estimate of the mean soil concentration for the site.

Some pre-SMP samples also were collected at depths greater than 2 feet BLS, in 2 foot intervals down to 8 feet BLS. Because all soil deeper than 2 feet BLS is considered to be subsurface soil with respect to human health exposure, we will address these subsurface samples as one group. The following table, (table 2) presents the summary statistics for the pre-SMP subsurface soil analytical results.

Table 2.

| Arsenic in Soil | Frequency of Detection | Mean Detected Concentration (mg/kg) | 95% UCL of the Mean Concentration (mg/kg) | Maximum Detected Concentration (mg/kg) |
|-----------------|------------------------|-------------------------------------|---|--|
| > 2 feet bls | 193 of 204 | 4.7 | 5.2 | 160 |
| 2 to 4 feet bls | 65 of 68 | 3.8 | 5.1 | 25 |
| 4 to 6 feet bls | 62 of 68 | 7.3 | 9.9 | 160 |
| 6 to 8 feet bls | 57 of 68 | 3.1 | 4.1 | 43 |

Arsenic was detected above the reported detection limit in 193 of 204 subsurface soil samples. The mean detected concentration for the data is 4.7 mg/kg (lognormal), and the 95% UCL of the mean concentration is 5.2 mg/kg. Arsenic was detected in subsurface soil (greater than 2 feet BLS) at a maximum concentration of 160 mg/kg in one sample from the 4 to 6 foot interval at the extreme southern property boundary. It should be noted that this 160 mg/kg concentration is approximately four times greater than the next-highest value (43 mg/kg in the 6-8 foot interval), and likely represents a statistical outlier.

A total of 1,759 post-SMP samples were collected from the 88 stockpiles described above. The version of the Florida UCL tool available at the time functionally was limited to evaluations of less than or equal to 1,000 samples, so U.S. EPA's ProUCL tool (U.S. EPA, 2002) was used for calculations involving more than 1,000 samples. The overall 95% UCL of the mean concentration for all available post-SMP samples is 2.4 mg/kg (mean concentration of 2.2 mg/kg). As shown on the next table, (Table 3) when pre-SMP samples from all depth intervals and all available post-SMP samples are combined, the site-wide mean concentration for these 2,031 samples is 2.4 mg/kg and the site-wide 95% UCL concentration is 2.8 mg/kg.

Table 3.

| Arsenic in soil from | Number of Samples | Mean Detected Concentration (mg/kg) | 95% UCL of the Mean Concentration (mg/kg) | Maximum Detected Concentration (mg/kg) |
|-------------------------------------|-------------------|-------------------------------------|---|--|
| 88 Post-SMP Stockpiles | 1,759 | 2.2 | 2.4 | 26 |
| Post-SMP and Pre-SMP Samples | 2,031 | 2.4 | 2.8 | 160 |

The mean and 95% UCL of the mean concentrations are based on the non-parametric Chebyshev test because the data is neither normally distributed nor lognormally distributed (U.S. EPA, 2002).

Subsequently, an independent, nearby off-site evaluation of background arsenic concentrations in surface soil concluded that approximately 3 mg/kg was indeed a reasonable estimation of regional conditions.

4. DISCUSSION

The mineralogic make-up of the soil at the Site, along with the horizontal and vertical distribution of the data, strongly suggests that the arsenic is of a naturally occurring origin, rather than the result of anthropogenic historical release of, for example, arsenic-containing herbicides or pesticides at the land surface. In particular, the soils in the vicinity of the Site are rich in phosphorus (e.g., phosphate), which is known to be associated with elevated levels of arsenic in soils, including Florida soils.

Arsenic concentrations at many Florida sites have been reported above the current U.S. Environmental Protection Agency (EPA) soil screening level (0.4 mg/kg) and above the then-current FDEP default residential exposure SCTL of 0.8 mg/kg (Chen et al., 2001). That 0.8 mg/kg value was modified to 2.1 mg/kg by the FDEP in February 2005 based primarily on modifications to relative oral bioavailability of arsenic from Florida-specific soils. In the Chen et al. study of background concentrations of arsenic in Florida soils, 27 out of the 51 Florida counties that were evaluated contained arsenic concentrations in soil above the EPA soil screening level (Chen et al., 2001). Ten out of the 51 counties that were evaluated had arsenic concentrations in soil above the FDEP contemporary residential exposure SCTL of 0.8 mg/kg. That same study also identified generally elevated arsenic concentrations above FDEP's residential exposure SCTL in a geographic "belt" from Leon and Madison counties (in northwest Florida) to Lee and Charlotte counties (in southwest Florida). That belt includes Hillsborough County, in which the project Site is located. Surficial soils in this geographic belt are predominantly sandy, but include a variety of relatively clayey substrata, limestone, and organic deposits. Most importantly, this geographic belt also includes soils from all four types of phosphate rock deposits that occur in Florida. A comparison of the phosphate rock deposits in Florida and potential arsenic contaminated sites shows that Florida phosphate deposits may be a source of elevated arsenic concentration in soil in those areas (Blakey, 1973). Furthermore, in proceedings of the Fertiliser Society, data were presented showing an arsenic concentration range from 4 mg/kg to 25 mg/kg with a reported average of 11.29 mg/kg in 15 central Florida phosphate rock samples (van Kauwenbergh, 1997). In at least one area on the Site, this pattern of elevated arsenic concentrations in segregated strata has been confirmed. A shelly layer from 3 to 5 feet below land surface was identified in the northeast portion of the site that contains notably higher concentrations of arsenic than the layers above and below (Langan, 2005).

Soil analytical data collected for the property clearly support the conclusion that the concentrations of arsenic in soil at the property are due to natural geologic conditions (i.e., the presence of phosphate deposits and related materials). Further, in the case of typical anthropogenic releases of chemicals, including arsenic-containing mixtures, a vertical pattern of decreasing concentration with increasing depth generally is observed, and there customarily are one or more localized source areas or some historical soil disturbance. No such disturbances or source areas were reported during initial pre-SMP site investigation activities and, as shown on the following table (table 4), the 0 to 2 foot soil interval exhibits the lowest frequency of detection, the lowest average and the lowest 95% UCL concentrations when compared with the other, deeper intervals.

Table 4.

| Arsenic in Soil | Frequency of Detection | Mean Detected Concentration (mg/kg) | 95% UCL of the Mean Concentration (mg/kg) | Maximum Detected Concentration (mg/kg) |
|-----------------|------------------------|-------------------------------------|---|--|
| 0 to 2 feet bls | 48 of 68 | 1.2 | 1.8 | 6.2 |
| 2 to 4 feet bls | 65 of 68 | 3.8 | 5.1 | 25 |
| 4 to 6 feet bls | 62 of 68 | 7.3 | 9.9 | 160 |
| 6 to 8 feet bls | 57 of 68 | 3.1 | 4.1 | 43 |

FDEP states in multiple department Rules that "...the Department shall not require site rehabilitation to achieve a CTL for an individual contaminant that is more stringent than the site-specific background concentration for that contaminant..." No final guidance document regarding development of site-specific background concentrations currently is available from FDEP. However, the characterization and sampling effort that was conducted at the Site, even though the intent was not for the purpose of establishing site-specific background, represents a reasonable and thorough approach from which it is possible to conclude that the arsenic in soils at the Site represents a naturally occurring background condition. Thus, an appropriate site-specific SCTL may be the previously described site-wide 95% UCL of the mean concentration, 2.8 mg/kg.

To further buttress the background/data characterization line of reasoning, a more in-depth, risk-based discussion of the FDEP SCTL for arsenic is in order. The historical promulgated direct exposure residential SCTL for arsenic, at the time that all pre-SMP work was conducted, was 0.8 mg/kg (FDEP, 1999), based on a 30-year residential exposure and a target cancer risk of 1×10^{-6} (a population increase of one cancer in one million persons above the expected cancer rate). Over a several-year period, modifications were proposed to the SCTLs in general based on revised assumptions for parameters such as body weight, skin surface area and inhalation rate. In addition, chemical-specific adjustments were proposed for the arsenic SCTL based on studies showing reduced oral bioavailability of arsenic in Florida-specific soils.

This Relative Bioavailability Adjustment (RBA) factor was addressed in detail by the Department and several groups which were formed by FDEP for the purpose of providing technical recommendations to the Department for its consideration in agency rulemaking. The Methodology Focus Group (MFG) of the Contaminated Soils Forum met numerous times over several years to review the arsenic issue and to consider in detail the available scientific information in support of specific assumptions. In March 2003, the MFG presented its findings to the Department in the form of a letter (DeMott, 2003) which recommended that a Relative Bioavailability Adjustment of 25% (= bioavailability correction factor of 4x) be used, based upon the results of a primate study, using a range of Florida soils, that was conducted at the University of Florida, and was funded by the Department (Roberts et al., 2002).

After further review in the context of rule development for Chapter 62-777, the Department concluded that a RBA of 33% (= bioavailability correction factor of 3x) was appropriate (UF/FDEP, 2004), but provided no additional technical foundation for that specific decision. This 3-fold correction factor to account for bioavailability was incorporated into a proposed arsenic SCTL of 2.1 mg/kg (FDEP, 2004b) that subsequently was finalized and adopted in February of 2005 (FDEP, 2005). This 2.1 mg/kg value still has as its basis a target cancer rate of one in one million and the underlying assumption of 30 years of exposure. It should be noted that using a correction factor of 4x, as recommended to the Department by the MFG, would result in a proposed arsenic SCTL of 2.8 mg/kg, also a value which is based on cancer protection at the one-in-one million rate. The overall 95% UCL concentration of 2.8 mg/kg for the Site represents a very nominal increased cancer risk (1.3×10^{-6} or 1.3 in one million) as compared with the current FDEP default residential SCTL of 2.1 mg/kg.

As of February 2005, the following 20 states utilize a default screening target concentration that is less restrictive than 2.8 mg/kg, with values ranging from 3.9 mg/kg to 24 mg/kg:

| | | |
|-------------------|---------------|----------------|
| Arizona | Massachusetts | New York |
| Connecticut | Maine | North Carolina |
| Illinois | Minnesota | Ohio |
| Indiana | Missouri | Pennsylvania |
| Iowa (deep soils) | New Hampshire | Texas |
| Kansas | New Jersey | Washington |
| Kentucky | New Mexico | |

Further, these and other states have granted actual cleanup concentrations on a site-specific basis which exceed even the 24 mg/kg level. At a number of Florida sites, the U.S. EPA has implemented

soil cleanup targets of 20 mg/kg or more in residential or other unrestricted land use circumstances. Thus, while the FDEP has exercised its prerogative to set a highly conservative guideline with respect to protective soil arsenic concentrations, an exceedance of that 2.1 mg/kg criterion does not necessarily indicate a hazard to human health.

5. CONCLUSION

In summary, it is apparent that the observed arsenic concentrations in soil at the Site represent a naturally occurring condition (2.4 mg/kg average and 2.8 mg/kg 95% UCL concentration drawn from over 2,000 samples from all portions of the Site). The close agreement between the mean concentration and the 95% UCL concentration indicates a low degree of statistical variability across the Site, and is supportive of the conclusion that the observed distribution represents naturally occurring background. No historical activities on the Site are known or expected to have resulted in arsenic use or releases on the property. Further, although the 2.8 mg/kg 95% UCL level exceeds the FDEP default residential cleanup target of 2.1 mg/kg, it does not represent a significantly increased human health risk, as evidenced by a cancer risk level of 1.3×10^{-6} compared to the default goal of 1.0×10^{-6} . Given the nature of typical well-developed residential neighborhoods (i.e., limited areas of bare soil), coupled with the fact that few residential activities involve daily direct contact with bare soil, exposures at the Site will not approach the conservative assumptions that were relied upon to develop the FDEP default residential cleanup target of 2.1 mg/kg (i.e., 350 days/year exposure for 30 years at 200 mg/day assumed soil ingestion, plus dermal and inhalation contact).

REFERENCES

- Blakey, A.F. 1973. *The Florida phosphate industry: a history of the development and use of a vital mineral*. Cambridge, MA, Harvard University Press.
- Chen, M., Ma, L.Q., Hoogeweg, C.G., and Harris, W.G. 2001. Arsenic Background Concentrations in Florida, U.S.A. *Surface soils: Determination and Interpretation*. Environmental Forensics, Vol.2, 117-126.
- DeMott, R.P. 2003. Chairman's Letter to Mr. John Ruddell, Director, FDEP Division of Waste Management. Dated March 7, 2003.
- FDEP (Florida Department of Environmental Protection). 1999. Chapter 62-777, F.A.C. Effective Date August 5, 1999.
- FDEP (Florida Department of Environmental Protection). 2004a. Florida UCL tool version 0.97. Software for calculating 95% upper confidence limit of mean concentrations.
- FDEP (Florida Department of Environmental Protection). 2004b. Chapter 62-777, F.A.C. Workshop Draft. October 2004.
- FDEP (Florida Department of Environmental Protection). 2005. Chapter 62-777. Contaminant Cleanup Target Levels. April 17, 2005.
- Langan (Langan Engineering & Environmental Services, Inc.). 2005. Personal communication.
- Roberts, S.M. et al. 2002. Measurement of arsenic bioavailability in soil using a primate model. *Toxicological Sciences* 67: 330-310.
- UF/FDEP. 2004. Technical Report: Development of Cleanup Target Levels (CTLs) for Chapter 62-777, F.A.C. Prepared for the Florida Department of Environmental Protection by University of Florida, Center for Environmental & Human Toxicology. Gainesville, FL.
- U.S. EPA. 2002. ProUCL software v 3.00.02. National Exposure Research Laboratory Technical Support Center.
- Van Kauwenbergh, S.J. 1997. Cadmium and Other Minor Elements in World Resources of Phosphate Rock. *Proceedings No. 400*. The Fertiliser Society, London, October 9, 1997.

PART IV: Brownfields

Chapter 8

URBAN FILL CHARACTERIZATION AND RISK-BASED MANAGEMENT DECISIONS - A PRACTICAL GUIDE

Draft

William R. Swanson and Pamela Lamie

CDM, 50 Hampshire Street, Cambridge, MA 02139 Tel: 617-452-6274, E-mail: swansonwr@cdm.com and lamiepo@cdm.com

Abstract: This paper examines contaminants in urban fill soil via background concentrations, disposal facility parameters and limits, and no-significant risk limits for site closure. It provides a guide when considering what might be expected at brownfields sites and how the findings at a site may be used to make practical soil management decisions. The approach is based on experience in Massachusetts following Massachusetts Department of Environmental Protection (MassDEP) regulations and guidance.

It is evident that urban fill soil may be expected to contain contaminants, in particular, heavy metals and polynuclear aromatic hydrocarbons, from specific releases and background sources. Natural concentrations and background concentrations are important sorting and selection criteria in evaluating which chemicals should be selected for analysis and which should be considered background. This paper discusses lead, arsenic, carcinogenic polynuclear aromatic hydrocarbons, dioxins, polychlorinated biphenyls, and asbestos. The authors outline each contaminant, the usual range in natural and urban fill soils, and its risk-based or related thresholds, with emphasis on the New England area. The outcome is a range of concentrations that can be used as a guide when considering brownfields sites such that their information may be compared to the ranges and brought into meaningful focus.

Key words: lead, arsenic, carcinogenic polynuclear aromatic hydrocarbons, dioxins, polychlorinated biphenyls, and asbestos

1. INTRODUCTION

The evaluation of numerous sites characterized by the presence of urban fill has revealed that there are several key contaminants, particularly, lead, arsenic, and polynuclear aromatic hydrocarbons (PAHs) that are consistently present at a high frequency. Other key contaminants, such as polychlorinated biphenyls (PCBs), may be detected less frequently. Dioxin, which is analyzed relatively infrequently, may also drive potential human health risks when present in urban fill. These constituents are also subject to environmental regulations at the national, state, and sometimes at the local level.

To determine if the concentration of a particular key contaminant is relatively “high” or “low,” there are three status areas or zones that may be defined based on the potential for human health risk. The first zone is a No Significant Risk level. From a human health perspective, a condition of No Significant Risk has been achieved if cumulative noncancer risk is calculated at a Hazard Index of one

and if cumulative cancer risk is at a level of not more than one additional cancer occurrence per 100,000 persons. Any given background concentration, either naturally occurring or anthropogenic, may fall into the risk-based No Significant Risk zone or could potentially fall into the second Probable (Potential) Risk zone. Further along the scale are “acute” levels such as would cause a risk if present for a short-period of time (called an Imminent Hazard by (Massachusetts Department of Environmental Protection (MassDEP)) or the upper concentration limit (UCL), defined by MassDEP as a potential long-term or future risk to public welfare—health, safety, and the environment. In this assessment, each of the key urban fill contaminants is defined by these zones or status areas: using a “green” zone, within which there is little likelihood of significant risk; a “yellow,” or cautionary zone, where risk may occur, but might be dealt with by institutional controls—or capping, venting, and containment; and a “red” zone, where remedial actions in the form of reduction, removal, or very robust, costly impediments to contact are required. Nothing about these ranges is absolute—they are based on the judgment of the authors and are thresholds or guiding values for an initial assessment or interpretation, subject to refinement by a professional risk assessor and the specifics of applicable regulations.

The selection of these zones is based on an extensive literature search of the following:

1. Background levels in the literature based on either naturally occurring concentrations or widespread anthropogenic occurrence;
2. Risk-based concentrations based on residential direct contact with soil computed using MassDEP methods (MassDEP, 2006);
3. State and federal standards and Preliminary Remediation Goals (PRGs) based on either human health risk, background, achievable detection limits, or other considerations; and
4. Upper bound levels or cut-off limits above which a risk is considered inevitable based on a short-term exposure scenario or a long-term potential or acute threat to the environment.

2. MATERIAL AND METHODS FOR SELECTION OF KEY CONTAMINANTS

The following selected parameters/contaminants are presented in the paper in alphabetical order: arsenic, asbestos, dioxin, lead, PAHs, and PCBs. These parameters/contaminants were selected because they represent key contaminants with background and risk-based concentrations of interest to brownfields, particularly PAHs and lead.

Reasons for contaminant selection are as follows:

- Arsenic and lead are the most problematic of the metals based on our experience with fill in old urban areas and with railroad beds and rural areas affected by historical pesticide use. Some generalizations based on experience are that in urban fill, lead is the metal of concern in a majority of the cases where metals are an issue, including toxicity characteristic leaching procedure (TCLP) failures. Arsenic may occur naturally and was used in lead arsenate pesticides on orchards and herbicides along railroads. Decaying treated timber is another arsenic source. It is rare to find an urban fill site dominated by other metals without one or the other of these metals playing a significant role.
- Asbestos, currently being studied by MassDEP, is soon to be more precisely regulated as an urban fill soil contaminant. The concept of background is worthy of mention in regard to the latest research. It had widespread use for several decades and appears quite regularly in urban fill.
- Dioxin is typically present in urban fill, though not often analyzed for. Its consideration was of interest especially in old urban areas with a long history of burning, especially by waste incineration, up to about 35 years ago.

- PAHs are generally present in urban fill and often affect the overall site risk. When assessing urban releases, their presence from a myriad of sources is often a confounding factor.
- PCBs are generally present, but often at levels below normal cleanup goals or detection limits. However, the regulatory position, persistence, and disposal cost impacts associated with PCBs made them worthy of inclusion in this document.

Hence, arsenic, lead, and PAHs are the primary contaminants of concern in urban fill. PCBs, asbestos, and dioxin have been included to give a more complete and balanced picture. While petroleum contaminants may be widespread constituents in urban fill soils, volatile organic compounds (VOCs) and petroleum contaminants are generally not considered significant risk drivers. Since there are no naturally occurring sources, VOCs tend to volatilize in soil rather than adhere to soil particulates, and heavier petroleum contaminants generally have a relatively low toxicity compared to the other risk drivers. We note, however, that total petroleum hydrocarbon concentrations may be a factor in soil disposal as it is a key regulated disposal parameter.

3. RESULTS BACKGROUND

The literature suggests there are a number of definitions that can be applied to the term “background.” One is strictly natural soil that has been unaltered by humans. Such soil would be natural soil in an excavation or pit that had not previously been worked, excavated, affected by air pollution fallout, or affected by contaminated groundwater flow through. The second is natural soil that has been altered by its presence in the urban environment or in widespread agricultural activity. The third is soil in the urban environment that has been extensively altered and contains evident or noticeable debris; asbestos containing material, coal ash, or wood ash, often being locations of old landfills. MassDEP (MassDEP, 2002) has developed well-supported background concentrations, viewed as statistical upper limits for the second and third definitions above and as referenced by contaminant below.

Background can be further described as follows:

1. Truly natural materials, especially arsenic and asbestos mineral groups that can be widespread and of health risk concern, with significant impact potential, not to be ignored on the basis of “natural.”
2. Widespread impacts, such as lead, PCBs, or dioxins that can be at low concentrations in soil over a large area due to the airborne nature of the delivery.
3. “Widespread polluted fill” (CTDEP, RSRs) due to landfilling to dispose of waste to “create land” in urban areas, such as the entire Boston waterfront. When severe fires occurred, the building debris was used as fill, and, sometimes, fire debris or just demolition debris was simply built over. Lead and PAHs are often the risk drivers in this setting. Asbestos may also appear, depending on when landfilling occurred. The most intense use of asbestos occurred from the industrial revolution through the 1970s.

Of the literature values available, PAHs as characterized by benzo(a)pyrene in this effort, seemed the most problematic in terms of defining thresholds. Based on our experience in the Boston urban environment and eastern Massachusetts, this difficulty in defining thresholds was somewhat unexpected. MassDEP (MassDEP, 2002) has established some well-supported background concentrations, but those appear higher than standards or background values in other areas. Since Boston is an older city compared to a number of other locations, these concentrations are probably due to anthropogenic buildup related the longer time period involved in the accumulation or “banking” of the material and substantial burned debris in the fill. In many respects, excepting natural materials, the urban east should usually be above average in this regard.

The terms, “high,” “low,” and so forth when used herein, are relative with reference to risk-based concentrations.

There is no exact number for background that stands out under any listed parameter, as the levels will vary somewhat from location to location. However, some general consensus within an order of magnitude is generally possible and will point the user into “danger (red) and comfort (green) zones.”

All referenced or derived soil concentrations shown on the figures are milligrams/kilogram (mg/kg) (or parts per million (ppm)) dry weight basis except for dioxin which is nanogram/kilogram (ng/kg) (or parts per trillion (ppt)) dry weight basis. As noted, several of the figures (Figures 1, 3, 4, and 5) are color coded, green generally meant to represent an acceptable limit (background or risk based), yellow to represent a caution or problematic concentration limit, and red serves to denote concentrations that are at unacceptable levels. While necessarily imperfect due to the array of sources and approaches, the figures serve as a useful guide to risk-based levels, as well as a guide to background levels in the urban environment. A horizontal arrow on the figure notes that the range may extend across one or both of the established boundaries.

4. RISK-BASED CONCENTRATIONS

The residential risk-based concentrations that were calculated for the key contaminants (other than asbestos) employed exposure assumptions used in the derivation of MassDEP Soil Standards. The values were set at a 1E-05 (1 excess cancer risk in a population of 100,000 persons). For the evaluation of cancer risk for arsenic, PAHs, dioxin, and PCBs, a 30-year cumulative risk was calculated for three age groups: young children ages 1-8 years, older children 8-18 years old, and adults 18-31 years old. For the evaluation of noncancer risk for lead, the most sensitive age group, young children ages 1-8 years old, were evaluated. For each age group evaluated for the direct contact exposures, including incidental ingestion of soil and dermal contact, it was assumed that exposure occurs approximately 5 times per week for 30 weeks, totaling 150 exposure events per year. For the calculation of dermal risk, a skin surface area was calculated assuming the face, hands, forearms, lower legs and feet would be exposed to soil.

5. DISCUSSION (BY SELECTED CONSTITUENT)

In the discussion below, we present background values established by others, provide summary comments, a computed risk number and relevant regulatory site remediation, and off-site disposal/or reuse criteria. Each chemical has an associated figure showing the key information. Where the available information was sufficient, the figure is provided with a scale at the bottom indicating three levels with two dividing concentrations. The green level at the lower left is a zone where risk-based and background parameters dominate. Collectively considered these suggest a low potential risk, or at least a tolerable risk. The yellow level between the end of the green to the next number is the zone where there is an appreciable potential risk and some measures will need to be taken. The red level contains the criteria where there is potential for short-term, acute, substantial, or imminent hazard impacts. The red zone contains numbers well above all but rare natural background conditions, such as arsenic-containing rock or natural asbestos.

| No Significant (Potential) Risk | Probable (Potential) Risk | Certainty of (Potential) Risk |
|---|---|---|
| Background | 75 (max.) - Boston Blue Clay, Arsenic in Rock, Worcester Co, MA, Belt | |
| 20 - MA | | |
| 11 - NH | | |
| 0.02-350 (typically <40) - US -34 states | | |
| Pesticide Use (Homes, Orchards) | | 100's |
| Treated Timber Decay (Play equipment, guardrail) | | 100's (also varies according to original treatment) |
| 0.02-48.9 - NJ | | |
| 2-6 Denmark | | |
| ND- 48 Delaware | | |
| 14 - Louisiana | | |
| 7 - Washington State | | |
| 3- 12 - NY | | |
| 10-20 - NY | | |
| 5 (5,776 samples-ave. extraction test) North Carolina | | |
| 2.12 - 26 Texas | | |
| 7.9-31 - Tennessee | | |
| 2.1-22 - Alluvial Soils Glacial Till & Drift, US | | |
| 1.8-31.0, most <20- Oakland, CA | | |
| ND-10-Resuspended Road Dust | | |
| Calculated Risk | | |
| 18- residential direct contact (cancer) | | |
| 0.06 - veg. growing | | |
| Standards | | |
| 20-MA | | |
| 11-NH | | |
| 7.5-NY | | |
| 23 - 0'-2' } Delaware | 40-potential imminent hazard (MassDEP, 2006) | 200-UCL - exceeds, then permanent solution not possible (MassDEP, 2006) |
| 101- 2'-6' } | | |
| 10 -CT | | |
| 7 - RI | | |
| 20-Denmark | | |
| Residential: 0.1 -250 (typically <20) | | |
| Industrial: 3 - 500 (typically <30) | | |
| (US-34 states) | | |
| Disposal Parameters | | |
| | 40 max.- Mass landfills/ Recycle (MassDEP, 2006) | 100-TCLP/RCRA Threshold (USEPA) |
| The Scale: ("cutoffs" or "thresholds") | | |
| | | |

Figure 1. Arsenic

Arsenic is a common contaminant in urban fill soils. Arsenic is naturally occurring in soil, but the primary source of widespread contamination is likely from pesticide use. In various urban park projects in Boston totaling more than 300 samples, arsenic was detected in approximately 90 percent

of the fill soil samples collected to characterize the sites. Due to the nature of arsenic's high toxicity to human health (a known carcinogen (EPA, 2006)), natural background and fill background concentrations (at 20 mg/kg) may be higher than actual risk-based concentrations. For example, a residential risk-based concentration at the No Significant Risk level is 18 mg/kg based on direct contact exposures. If the consumption of homegrown produce is considered an additional exposure pathway, then the risk-based concentration is 0.06 mg/kg.

By contrast, background levels may exceed risk-based levels and may even extend into the Potential/Probable Risk zone. The MassDEP background concentration for both natural soils and urban fill soils is 20 mg/kg, slightly higher than the residential risk-based concentration of 18 mg/kg. The 20 mg/kg fill background value was developed from approximately 750 soil samples from downtown Boston as well as some other studies. Natural soils vary from a few mg/kg to more than 40 mg/kg in an arsenic belt in Worcester County, Massachusetts. A concentration of 40 mg/kg is considered significant in Massachusetts as 40 mg/kg may constitute an Imminent Hazard condition, if the arsenic is present in surface soils accessible to young children such as in a residential back yard or a school or playground. Arsenic levels in Boston Blue Clay are often in excess of 40 mg/kg due to its natural mineral content. Soils affected by lead arsenate pesticides are often in excess of 40 mg/kg ranging up to hundreds of mg/kg. The 40 mg/kg limit also applies to soil reuse at Massachusetts in-state lined and unlined landfills under Policy COMM 97-001(MassDEP, 1997).

As noted on the figure, regulatory standards set to be protective of human health risk are 20 mg/kg in Massachusetts (based on background), 11 mg/kg in New Hampshire (based on background), 10 mg/kg in Connecticut, and 7 mg/kg in Rhode Island. As a useful guide, any concentration less than 10 mg/kg is likely attributable to background, while a concentration greater than 20 mg/kg is likely indicative of a site release, high natural soil depending on local geology, or pesticide use if there is a history of agricultural use. Natural soil would be defined by deeper, undisturbed, native material, while pesticides would likely reside in topsoil.

The MassDEP upper concentration limit (MassDEP, 2006) is 200 mg/kg, at and above which a permanent solution is not possible without further action.

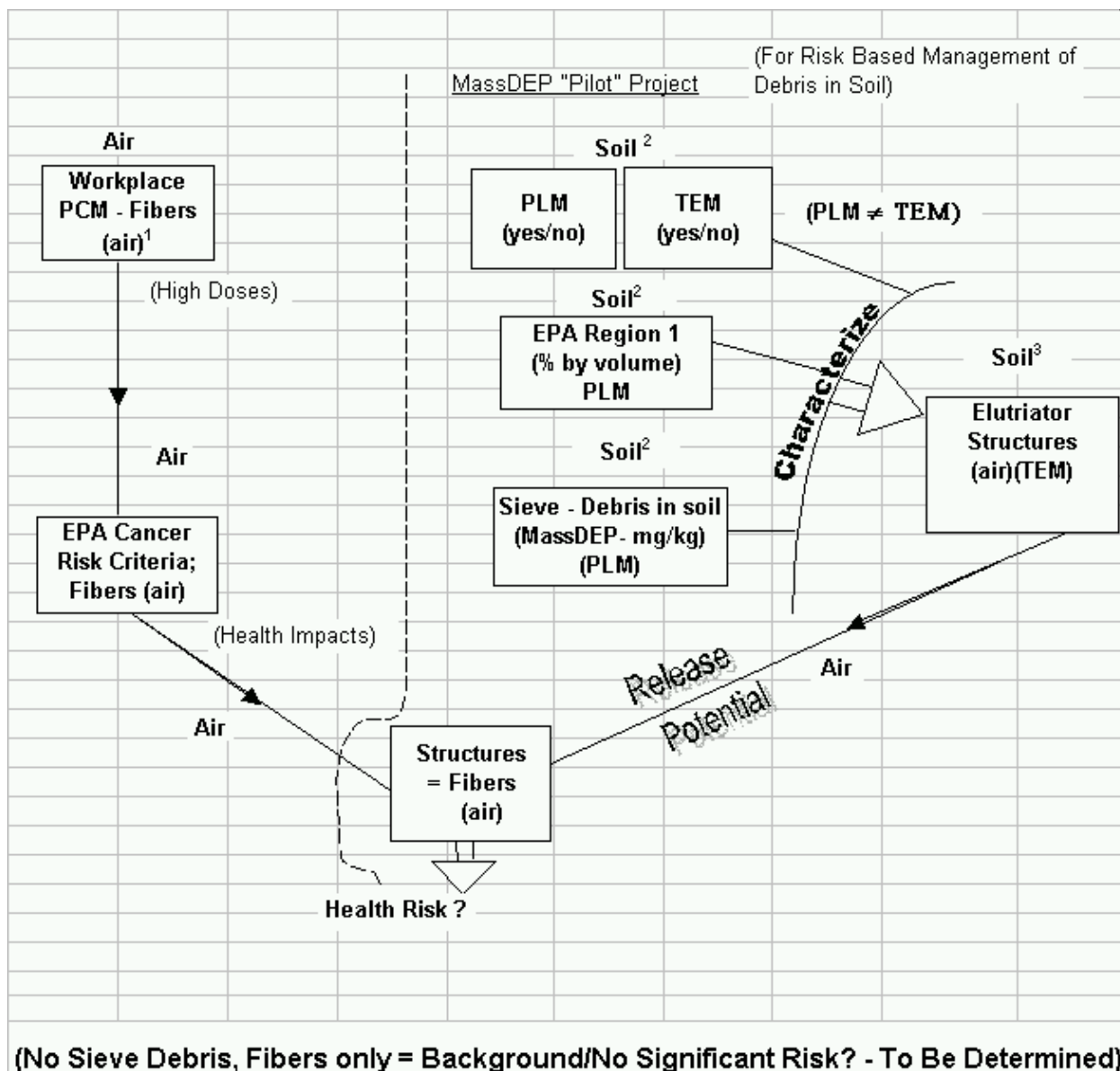

Figure 2. Asbestos

Notes

- 1.) Standards are available for "cleanup."
- 2.) No existing standards, MassDEP currently uses ND as "cleanup criteria."
- 3.) Possible standard development.

PCM - Phase Contrast Microscopy
 PLM - Polarized Light Microscopy
 TEM - Transmission Electron Microscopy

Air: 0.00001 to 0.0001 fibers/milliliter is "background." (ATSDR 2001)

The singular background value available is an air concentration noted for urban air quality. Otherwise, the information on Figure 2 illustrates our understanding of the MassDEP approach to sampling and analysis in preparation for additional asbestos regulations regarding impacted soil management and disposal. On the left of the Figure is the U.S. Environmental Protection Agency (USEPA) risk approach/numeric developed by phase contrast microscopy (PCM) data, and to the right is a representation by the authors of their understanding of the latest (draft) MassDEP method coming together as a soil management approach. Some key notes: Three analytical methods are used

and while all microscopy, are not equal. The MassDEP approach is quite functional, but the USEPA numeric is not necessarily comparable. However, all things considered, the approach is the most comprehensive available and is applicable to urban fill soil. As data is generated, more will be known. At this time, scattered fibers without any identifiable debris would probably serve as background.

There is no established background volume percentage or unit weight value in soil and various types of asbestos occur naturally throughout the world. Asbestos is a mineral fiber and comes in different sizes and shapes. Measurement techniques have evolved with microscopic viewing of building material, more recently applied to soil. Generally, if building material contains asbestos at less than 1 percent by volume, it is not considered asbestos containing. MassDEP is well along in establishing protocols for management of urban fill soil with asbestos debris and results to date are well developed but not final. There have been some air background numbers that might relate to soils, but we are not aware of a studied link.

There are large, natural deposits of these physically and chemically varied mineral fibers, particularly in California but with some in New England, notably asbestos mines in Vermont. There have been background or baseline numbers suggested for air, but, not to our knowledge, for soil. The diagram of Figure 2 illustrates the current study approach by MassDEP for urban fill soil containing asbestos debris and having the potential to release fibers to ambient (outdoor) air. While of a preliminary nature, it would appear that if no identified asbestos-containing material (ACM) debris can be sieved out of the soil sample, then there are not likely to be enough fibers present in the soil to cause a concern. The fibers present would be considered background in that respect. The presence of debris would constitute a source material beyond that expected of urban fill soil at background levels, with questions remaining as noted on the figure. A key issue is that USEPA's risk-parameter development is based on results from one measurement approach that does not necessarily correlate with the current methods to detect asbestos in soil or in particular in air generated in the elutriator device.

| No Significant (Potential) Risk | Probable (Potential) Risk | Certainty of (Potential) Risk |
|--|---|--|
| Background | | |
| Urban Location (0.86 - 80, Ave 17- Eastern, MA) (Impacted with Ash) | 50 - (ATSDR 1997) Screening value (max.) | Over 1,000 - (ATSDR 1997) - Action Level |
| 7 (Ontario) | | |
| 0.17-9.14 - Rural } 0.54 - 33.0 Urban } New Zealand | | |
| 0.77 - 77.4 - New Zealand | | |
| 4 - rural } 20-urban } USEPA | | |
| 16-189, Ave. 62- Canton, MA | 50-100 (ATSDR - 97) Evaluation Levels | |
| 0.21-42.9 - Colorado & Utah | | |
| 0.6 - 35 - Michigan | | |
| 0.15 - 13.3 - Ireland - Totals PCDD/PCDF | | |
| 0.009 - 0.15 England | | |
| Pre-1900, 0.30 - rural U.K. 1990's (Totals PCDD/PCDF) | | |
| 0.09-64 - EU | | |
| 0.78-17-Rural } 4.9 -87 - Urban } UK | | |
| 0.246-20-Rural Alaska | | |
| 0.05 -43- Australia | | |
| Calculated Risk | | |
| 60 (cancer) | | |
| Standards | | |
| 20 - MA | | |
| 90- Michigan | | 3,000 - UCL (MassDEP,2006) |
| 10-Ontario | | |
| 1000- Japan | | |
| 3.9 -200 - US (2 EPA Regions, 9 States) | | |
| The Scale: ("cutoffs or thresholds") | | |
| Green | Yellow | Red |
| | 50 | 1,000 |
| Notes: | | |
| 1.) Controversial Dow Chemical Site, considerable internet traffic, other studies. | | |
| 2.) Note- TEQ's used by persons may vary | | |

Figure 3. Dioxin (Generally as 2,3,7,8 TCDD Equivalent)

Dioxin is less commonly analyzed for than other urban fill parameters, probably partly due to its high analytical cost per sample. Natural background sources of dioxin include brush and forest fires and volcanic eruptions, although the contribution from natural sources is relatively small compared

with anthropogenic sources (USEPA, 2006b). The greatest environmental source is from historical industrialization that occurred from the 1920s through the 1970s. Airborne releases from commercial and municipal waste incineration, the manufacture and use of herbicides, and the land application of wastewater treatment sludge from pulp and paper plants resulted in major environmental releases (USEPA, 2006b). While strict controls have dramatically reduced industrial sources, the chemical's slow breakdown has resulted in its common presence in urban fill material.

Dioxins are a complex mixture of chlorine-containing compounds with differing toxicities and are assessed following a toxic equivalency approach by assigning a toxicity factor relative to the most toxic form - 2,3,7,8-tetrachlorodibenzo-p-dioxin (2,3,7,8-TCDD). These numerical factors transform concentrations of dioxin compounds into equivalent concentrations of 2,3,7,8-TCDD (USEPA, 2004a).

MassDEP has not established a background number for 2,3,7,8-TCDD, but samples collected in Canton, Massachusetts, a number of years ago provided an average value of 60 ng/kg. The value of 60 ng/kg is also the 1E-05 residential risk-based direct contact value. This number was a useful guide but never officially adopted. Recent private/independent work for a site outside of Boston involving the evaluation of old incinerator ash blended in urban fill soil yielded results ranging from 0.86 to 80 ng/kg, with an average of 17 ng/kg based on a 44 sample data set. USEPA (Rodan, 1997) established value of 20 ng/kg (2,3,7,8-TCDD) equivalent background, which was recently adopted by MassDEP as the basis of the residential S-1 soil standard.

We suggest a value of 20 ng/kg or less as generally background, and any value more than 100 ng/kg indicates a potential site release specific situation.

| No Significant (Potential) Risk | Probable (Potential) Risk | Certainty of (Potential) Risk |
|--|--------------------------------------|---|
| Background | | |
| 100 (max.) - Natural- MA | | |
| 600 (max) - Coal/Wood Ash - MA -----> | | |
| 9 -39 (Ave. 19 - 239 samples) - Ohio Farm soils (Secondary References 2- 200 (Ave.10) | | |
| 17 - Natural - Washington State | | |
| 4-61 Rural } North Carolina 200-500 Urban } | | |
| 15-240 - Scotland | | |
| 8- Natural, 19-78 City Parks, 10-110 - Farms/Forest - Russia | | |
| 10-40 - Denmark | | |
| 51- NH | | |
| <1.2 - 617 - NJ | | |
| 10-100 - NY | | |
| 17 - Washington State | | |
| 4 - (ave. 5,776 samples - extraction test) North Carolina | | |
| 23-36 Tennessee | | |
| 10-30 Alluvial Soils, Glacial Till & Drift, US | | |
| 3.3-148, most <20 - Oakland,CA | | |
| 40-350- Resuspended Road Dust | | |
| Calculated Risk | | |
| 840 (HI @ 1) | | |
| 1,260 (HI@1.5) | | |
| Standards | | |
| 300- MA | | Max's 3,000 - UCL (MassDEP 2006) |
| 278- NJ | | 100 TCLP Threshold (USEPA) |
| 400-Denmark | | 250 -CA/T TCLP Threshold (MassDEP 2002) |
| 500-Residential } CT | | 5,000 - HUD - Permanent Solution |
| 1,000 -Industrial } -----> | | |
| 400/ } Bare soil - play area/yard - USEPA Program | | Disposal: MA 1,000 Recycle, Unlined L.F's (Typ.) |
| 1,200/ } (Lead Only)-----> | | 2,000 Lined Landfills (Lead based paint debris exempt from TCLP Criteria) |
| 130 - Sediment Screening - MA | | |
| The Scale: ("cutoffs or thresholds") | | |
| Green | Yellow | Red |
| | 500 | 2,000 |

Figure 4. Lead

Lead has a high frequency of detection in urban fill soils. For example, lead was detected in 98 percent of the more than 300 samples collected to characterize various urban park sites in Boston. Lead is ubiquitous in urban fill soils due to its natural occurrence and anthropogenic sources, such as the historical use of leaded gasoline, leaded paint on building construction materials (including steel beams), and its presence in pipes and in solder.

Risk-based concentrations for lead are generally calculated based on noncarcinogenic health effects using the Integrated Exposure Uptake Biokinetic (IEUBK) Model based on an established blood level endpoint, as the USEPA has not established an oral reference dose (RfD) to calculated risks. MassDEP, however, has established an RfD to calculate lead risk as an alternative to using the model (MassDEP, 1992). Using this toxicity value, a residential risk-based value of 500 mg/kg is calculated based on direct contact. However, the actual residential soil standard is 300 mg/kg adopted from the land application of sludge regulations.

In general, concentrations considered to be at a No Significant Risk level are generally set in the 300 mg/kg to 500 mg/kg range. The Massachusetts residential standard for lead in soil is 300 mg/kg; the USEPA Region IX preliminary remediation goal (PRG) is 400 mg/kg (USEPA, 2004b); and the residential soil standard for Connecticut is 500 mg/kg. While natural background concentrations are generally 100 mg/kg or less and fall below the No Significant Risk level, MassDEP's background

concentration for fill soils containing coal or wood ash is 600 mg/kg. This value falls within the 500 mg/kg to 2,000 mg/kg Potential/Probable Risk range. Lead concentrations in the 500 mg/kg to 2,000 mg/kg range are generally acceptable for adult-only industrial use type exposure scenarios. The EPA Region IX Industrial PRG for lead is 800 mg/kg (USEPA, 2004b). Lead concentrations in urban fill typically fall within this range.

Upper bound limits of 3,000 mg/kg and 5,000 mg/kg have been established by MassDEP (MassDEP, 2006) and the Federal Department of Housing and Urban Development (HUD, 1995), respectively. At these concentrations, lead-contaminated soil must be removed, controlled, or contained.

| No Significant (Potential) Risk | Probable (Potential) Risk | Certainty of (Potential) Risk |
|---|--------------------------------------|--|
| Background | | |
| 2-Natural-MA - also max. allowed | } "90th percentile" | |
| 7- Coal/Wood Ash - MA - also max. allowed | | |
| 0.98 - 2.1 - Illinois - 95th percentile | | |
| 0.4 - Sweden | | |
| 0.1 - Denmark | | |
| low - "negligible," | | |
| <1-1.3 -NY | | |
| Calculated Risk | | |
| 7-8-Cancer, residential direct contact | | |
| Standards | | |
| 0.7 - MassDEP (pre. 2006) | | UCL |
| 2 - MassDEP 2006 (4-S-2 soil, 30-S-3 soils - lower exposure potential) | | 300 |
| 0.66 - NJDEP PQL (04) | | |
| 1.0 - Denmark | | |
| 1- CT | | |
| 0.088-2.5 - Range, 14 States (Cluster 0.6-0.7, ave. 0.63) | | |
| The Scale: ("cutoffs or thresholds") | | |
| Green | Yellow | Red |
| | 2 | 20 |

Figure 5. PAHs

PAHs as represented by benzo(a)pyrene, like metals, are ubiquitous in urban fill soils. Because PAHs are the product of incomplete combustion, they are detected in non-urban soils from fallout from forest fires and even volcanoes. They are particularly prominent in urban soils due to anthropogenic sources, such as gasoline and diesel exhaust, petroleum oils, and asphalt binders.

Benzo(a)pyrene is classified as a carcinogen (USEPA, 2006) and calculated, risk-based concentrations at No Significant Risk levels are often very low compared to concentrations of benzo(a)pyrene in fill soils. While the MassDEP 1 in 100,000-excess-lifetime-cancer-risk, risk-based residential direct contact standard for benzo(a)pyrene is 7.8 mg/kg, risk-based concentrations using USEPA guidance are an order of magnitude lower, due to different factors used in the calculations. The primary differences between these state and federal values are due to differences in dermal absorption factors and adherence factors and the omission of inhalation risks.

For example, residential risk-based PRGs calculated at a 1E-05 risk level from EPA Region III and Region IX are 0.87 mg/kg and 0.62 mg/kg, respectively (USEPA, 2006c) (USEPA, 2004b). Even PRGs calculated based on industrial exposures are relatively low with values of 3.9 mg/kg (Region III) and 2.1 mg/kg (Region IX) (USEPA, 2006c) (USEPA, 2004b). Since benzo(a)pyrene is considered mutagenic, these values may decrease further now that USEPA has issued guidance (USEPA, 2005a) for the assessment of mutagenic compounds that applies additional toxicity factors for the carcinogenic risk assessment of early life stages.

Given the very low risk-based values (less than detection limits in many cases), defining an appropriate background concentration for PAHs in fill is essential to achieve a condition of No Significant Risk. Therefore, it is essential to be able to distinguish between PAH concentrations attributable to background versus concentrations representative of a release. MassDEP evaluated several fill data sets, particularly the large 750 sample Central Artery/Tunnel project database and determined that the 7 mg/kg is an appropriate background concentration for benzo(a)pyrene in urban fill affected with coal and wood ash. In addition, 2 mg/kg was set as natural background and the residential standard was also recently adjusted accordingly to 2 mg/kg from 0.7 mg/kg based on background. Evaluating this data collectively, the No Significant Risk level is 2 mg/kg or less. The Potential/Probable Risk range is 2 mg/kg to 10 mg/kg, given the fill background value of 7 mg/kg. The upper bound value, is 300 mg/kg based solely on MassDEP's upper concentration limit (MassDEP, 2006).

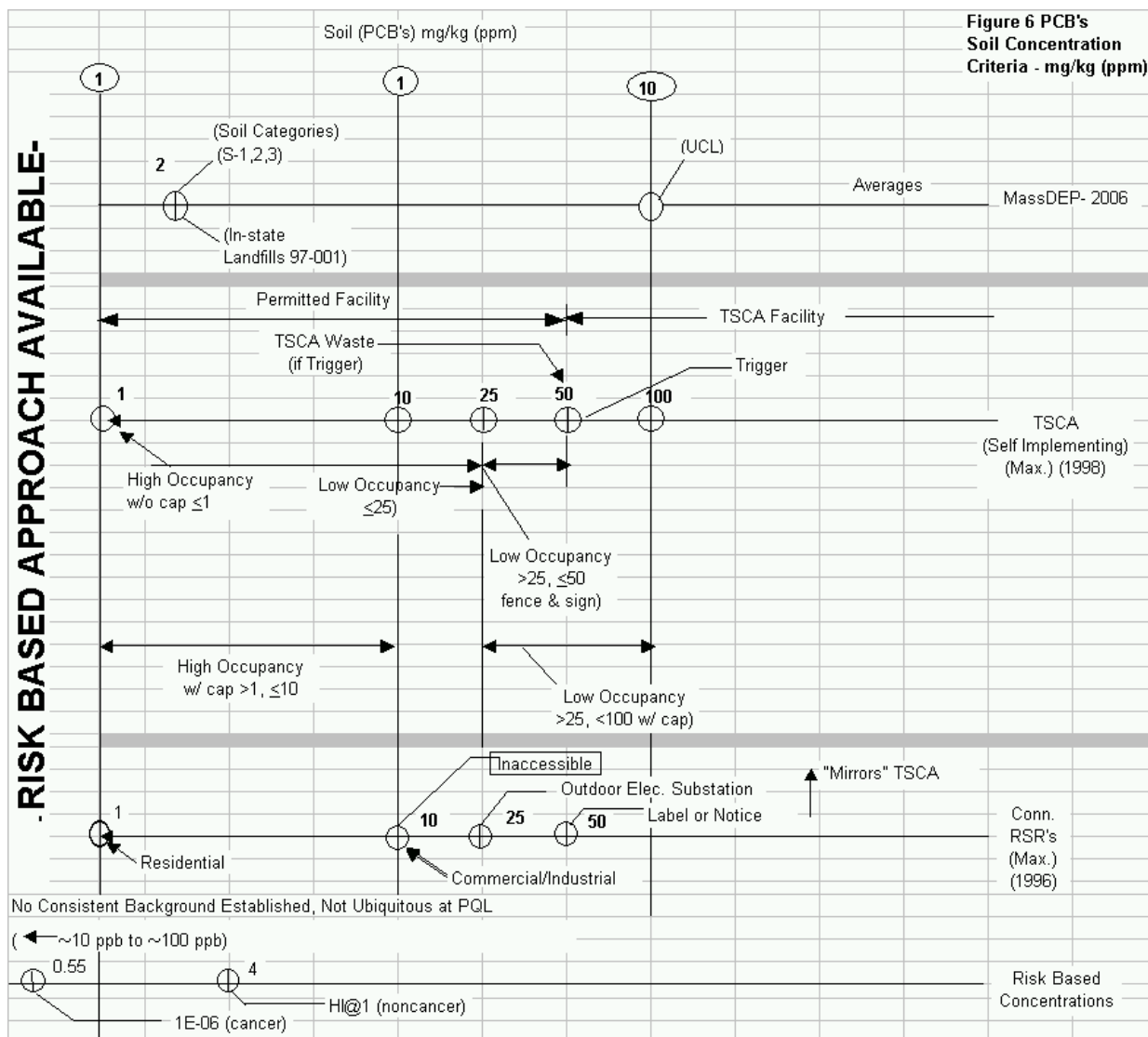

Figure 6. PCBs

For sites in industrialized areas with a history of PCB use, a determination of background levels is important due to the persistence and pervasiveness of PCBs. Concentrations ranging from 0.1 (1E-06 risk level) mg/kg to 1 mg/kg (1E-05 risk level) may be considered background (USEPA, 1990). However, because their presence may involve a multiple regulatory framework of both state regulators and USEPA under the Toxic Substances Control Act (TSCA), it was decided to provide a summary plot illustrating a range of values. This effort appears on Figure 6. The most important regulatory “trigger” is the 50 mg/kg TSCA limit. Its application depends on the date of release, but if one is doing remediation, any exceedance of the number means the activity is subject to TSCA and cleanup will be either 1 mg/kg maximum allowed of any point or a risk-based cleanup goal. (USEPA, 2005b) (Tisa, 2006)

The USEPA residential PRG of 1 mg/kg is based on very conservative exposure assumptions. For example, the ingestion rates for children and adults are two times greater than MassDEP ingestion rates; the inhalation pathway assumes that someone is on the site 24 hours per day for 30 years; and concentrations of PCBs in the air of a home will be the same as ambient air. Consequently, site specific, risk-based concentrations can be greater than 1 mg/kg. The MassDEP residential soil standard is 2 mg/kg (although adopted from land application of sludge regulations) and the calculated residential risk-based direct contact value is 5.5 mg/kg.

For industrial settings, the USEPA recognizes values ranging from 10 to 25 mg/kg as risk-based remedial goals (USEPA, 1990). At Superfund sites, these higher values are considered sufficiently protective for workers, since they are still within the acceptable range of 1E-04 using residential assumptions.

To put high end concentrations in perspective, the USEPA has guidelines for selecting remedial options based on whether PCB concentrations are considered either a principal threat or a low threat. It is expected that principal threats should be treated and includes soils with PCBs detected at greater than 100 mg/kg in residential locations and greater than 500 mg/kg in industrial locations. Consideration of containment should be given to low threat soils with concentrations 100 mg/kg or less. (USEPA, 1990)

6. CONCLUSIONS

| <i>Constituents</i> | <i>Air (Esp. Indoor)</i> | <i>Soil as Addressed in this Document</i> |
|--|------------------------------|---|
| Benzene, other gasoline related organics | ✓ | – |
| Chlorinated organics | ✓ | – |
| Metals (As/Pb) | – | (✓) |
| PAHs (Benzo(a)pyrene) | – | (✓) |
| Asbestos | ✓ | (✓) |
| Dioxin | – | (✓) |
| PCBs | – | (✓) |
| Pesticides | – | – |

Figure 7. Background Information Availability

1. Figure 7 summarizes all the constituents initially considered relative to urban background and a host of criteria. Gasoline-related hydrocarbons and chlorinated organics/degradation byproducts have background values for indoor air, but not for soil. This paper addressed the key metals arsenic and lead, PAHs by focus on benzo(a)pyrene, plus asbestos, dioxin, and PCBs, all related to soil. Pesticides were not addressed.
2. The authors reviewed the literature, examined available background criteria, displayed example standards, and computed current risk based numbers.
3. The authors selected two thresholds or concentration criteria. The first would cross from below standards, background, no significant risk, into a cautionary area of potential/probable risk. The second would cross onto a certainty of risk, a distinctly unacceptable situation requiring comprehensive action, potentially costly.
4. Finally, as illustrated at the bottom of Figures 1 through 6, the authors have provided a scale or key allowing the user to make an initial screening of site-specific data. Detailed or final analysis, however, must be accomplished by a professional risk assessor.

REFERENCES

- AEAT (AEA Technology). 1999. Compilation of EU Dioxin Exposure and Health Data, AEA Technology, Oxfordshire, England, OX 11 0QJ. 1999.
- AEHS (The Association for Environmental Health and Sciences). 2003. State Summary of Cleanup Standards. The Association for Environmental Health and Sciences, Amherst, MA 01002. 2003.
- Allsopp, M., 1994. Achieving Zero Dioxin, An Emergency Strategy for Dioxin Elimination. Greenpeace Communications, London. EC1R3DB. Sept. 1994.

- ATSDR (Agency Toxic Substances and Disease Registry). 1993. Public Health Assessment, Ramapo Landfill, Ramapo, Rockland County, New York. Appendices. Prepared by: New York State Department of Health, Albany, New York 12237, December 1993. <http://www.atsdr.cdc.gov/HAC/PHA/ramapo/r/f-p4.html>
- ATSDR (Agency for Toxic Substances and Disease Registry). 1997. Dioxin and Dioxin-Like Compounds in Soil, Part 1: ATSDR Interim Policy Guideline, Toxicology and Industrial Health, Vol. 13, No. 6. pp. 759-768, 1997. (Policy Effective date August 1997) <http://www.atsdr.cdc.gov/dioxindt.html>
- ATSDR (Agency for Toxic Substances and Disease Registry). 2001. Public Health Statement for Asbestos, Summary Chapter from: Toxicological Profile for Asbestos, Agency for Toxic Substances and Disease Registry, Department of Health and Human Services, Public Health Service. Atlanta, GA. 2001. <http://www.atsdr.cdc.gov/toxprofiles/ph61.html>
- ATSDR (Agency for Toxic Substances and Disease Registry). 2002. Public Health Assessment. Central Wood Preserving Company. Slaughter, East Feliciana Parish, Louisiana. Appendices. Prepared by Louisiana Department of Health and Hospitals, September 2002. http://www.atsdr.cdc.gov/HAC/PHA/central_wood/cwp_p2.html
- Baldwin, L. and McCreary, H. 1998. Study of State Soil Arsenic Regulations. Association for the Environmental Health of Soils, Amherst, MA 01002. December 1998.
- CDM 1991. Final Report/Subtask #8.2, Environmental Consequences of Utilizing Boston Blue Clay In Landfill Closure, Massachusetts Department of Public Works, Boston, MA 02110. Final Report, January 1991.
- City Farmer, 2003. Urban Agricultural Notes. Heavy Metal Concentrations in Urban And Peri-Urban Gardens of Dzerzhinsk and Nizhny Novgorod, Russia. Published by City Farmer, Canada's Office of Urban Agriculture. December 2003. cityfarm@intercharge.ubc.ca, <http://www.cityfarmer.org/russianmetal.html>
- City of Oakland, 2005. City of Oakland, Survey of Background Metal Concentration Studies, Oakland Urban Land Redevelopment Program, Oakland, CA 94612. December 2005.
- CTDEP (Connecticut Department of Environmental Protection) 1996. State of Connecticut. Regulation of Department of Environmental Protection concerning Remediation Standard (and related Guidance Documents) Hartford, Connecticut 06106-5127, January 1996.
- Danish Environmental Protecting Agency, 2002. Guidelines on Remediation of Contaminated Sites. Environmental Guidelines No. 7, 2002. (Only available online in English) www.mst.dk/udgiv/publications/2002/87-7972-280-6/html/default.eng.htm
- Department of Ecology. 1994. Natural Background Soil Metals Concentrations in Washington State. Publication #94-115. Executive Summary. Department of Ecology, Olympia, WA 98504-7600, October 1994.
- DEH (Department of the Environment and Heritage). 2004. Dioxins in soil in Australia, Technical Report No. 5, Department of the Environment and Heritage, Parkes ACT 2600 Australia. ISBN0642 S49974. May 2004.
- DEQ (Department of Environmental Quality). 1999. Michigan Soil Background Dioxin Data, Sample Locations and Results as of November 1999. Department of Environmental Quality, Lansing, Michigan 48909-7973. November 1999.
- DEQ (Department of Environmental Quality). 2004. Dioxin Contamination in the Midland Area. Department of Environmental Quality, Lansing, Michigan 48909-7973. July 2004.
- DNREC (Department of Natural Resources and Environmental Control). 2005. Arsenic References, Cleanup of Arsenic – Contaminated Sites, Dover, DE 19901. August, 2005. <http://www.dn.rec.state.de.us/dnrec2000/Divisions/AWM/SIRB/Arsenic/index.htm>
- Dow (Dow Chemical). 2006. What is the 90 ppt Standard? Listed Under Regulatory Activities, 2006. <http://www.dow.com/facilities/numerical/michigan/dioxin/regulat/standards.htm>.
- European Commission. 2004. Dioxin & PCBs: Environmental Levels and Human Exposure in Candidate Countries, Summary Report. European Commission, Brussels. June 2004.
- Fleischer, Philip, RE: Background Dioxin Levels?, August 1997 <http://lists.essential.org/1997/dioxin-l/msg00324.html>
- Folkes, D.J., and Keuhster, T.E. 2001. Contributions of Pesticide use to Urban Background of Arsenic in Denver, Colorado, U.S.A. Environmental Forensics. 2, 127-139. April 2001.
- HUD (The U.S. Department of Housing and Urban Development). 1995. Guidelines for the Evaluation and Control of Lead-Based Paint Hazards in Housing. June 1995.
- Illinois EPA (undated). Urban Area Polycyclic Aromatic Hydrocarbons Study Tiered Approach to Corrective Action Objectives. Tabulation Background Carcinogenic PAH 95th Percentile Concentrations (mg/kg) Springfield, Illinois 62702
- MassDEP (Massachusetts Department of Environmental Protection) 1992. Documentation for the Risk Assessment Shortform Residential Scenario. Office of Research and Standards and the Bureau of Waste Site Cleanup. Policy #WSC/ORS-142-92. October 1992.
- MassDEP (Massachusetts Department of Environmental Protection) 1997. Reuse and Disposal of Contaminated Soil at Massachusetts Landfills, Policy #COMM97-001. Department of Environmental Protection, Boston, Massachusetts 02108. August 1997.
- MassDEP (Massachusetts Department of Environmental Protection) 2002. Technical Update, Background Levels of Polycyclic Aromatic Hydrocarbons and Metals in Soil. Department of Environmental Protection, Boston, MA 02108-4746. May 2002.
- MassDEP (Massachusetts Department of Environmental Protection) 2006. Massachusetts Contingency Plan, 310 CMR 40.0000, (and related Guidance Documents) Massachusetts Department of Environmental Protection, Boston, Massachusetts 02108. April 2006.

- MCES (Metropolitan Council Environmental Services) 2004. A Survey of Regulations Used to Control the Use and Disposal of Stormwater Pond Sediments in the United States and Canada, Metropolitan Council Environmental Services, EQA, Saint Paul, MN 55101, Report 04-542. November 2004.
- Midland Health Watch, Facts on soil standards. http://www.midlandhealthwatch.com/facts_on_soil_standards.htm
- Natural Background Soil Metals Concentrations in Washington State, Publication #94-115, October 1994
- NJDEP (New Jersey Department of Environmental Protection and Energy). 1993. A Summary of Selected Soil Constituents and Contaminants at Background Locations in New Jersey. New Jersey Department of Environmental Protection and Energy, Site Remediation Program, Trenton, New Jersey. September 1993.
- NHDES (New Hampshire Department of Environmental Services), 2001. Table 1. Revised Background Concentrations of Metals in Soil. NHDES Risk Characterization and Management Policy (Subsection 1.5(4)(c)). (Revised) Concord, NH 03302-0095. April 3, 2001.
- NYSDEC (New York State Department of Environmental Conservation). 1994. Heavy Metals Soil Cleanup Criteria. Table 4 Recommended soil cleanup objectives (mg/kg or ppm) Heavy Metals. Division of Environmental Remediation. TAGM#4046. January 1994. <http://www.dec.state.ny.us/website/der/tagms/prtg4046e.html>
- NCDA & CS (North Carolina Department of Agriculture & Consumer Services) 2006. Heavy Metals in North Carolina Soils, Occurrence and Significance. North Carolina Department of Agriculture & Consumer Services, Agronomic Division, Raleigh, NC. Last Updated February 2006. <http://www.ncagr.com/agronomi/hflyer.htm>
- Ohio State University. 2001. Background Levels of Heavy Metals in Ohio Farm Soils, Research Circular 275-83. Columbus, Ohio 43210. July 2001. <http://ohioline.osn.edu/re275/re275-3.html>
- Ontario, 2004. Soil, Groundwater and Sediment Standards for Use Under Part XV.1 of the Environmental Protection Act Queen's Printer for Ontario. March 2004.
- Pattle Delaware Partners LTD. 2002. Dioxin Concentrations in Residential Soil, Paritu, New Plymouth. Ministry for the Environmental, New Zealand. September, 2002. <http://www.mfe.govt.nz/publications/hazardous/taranaki-dioxin-report-sep02/index.html>
- RAIS (The Risk Assessment Information System) 2006. The Risk Assessment Information System, USDOE, Oak Ridge Operations Office, TN 37830 Last Updated: April 27, 2006. <http://risk.lsd.ornl.gov/cgi-bin/background/generic>
- R&H Hall. Technical Bulletins. 1999. Dioxins/PCB's and the Food Chain-A Review. R&H Hall, Dublin 8, Ireland. 1999. http://www.rhall.ie/bulletins/diox_4.htm
- Rocky Mountain Center for Occupational and Environmental Health. 1999. A Comparison of Dioxin Levels, Found in Residential Soils of Davis County, Utah with those found in Residential Soils in the Denver Front Range, Department of Family and Preventative Medicine, University of Utah. 1999.
- Rodan, B.D., 1997. Polychlorinated Dioxins and Furans: Sources, Emissions, and Levels. National Center for Environmental Assessment, Office of Research and Development, U.S., Environmental Protection Agency, Washington, DC 20460. Presented at UNEP Regional Awareness Raising Workshop on POP's, Bangkok, Thailand, November 1997.
- Rutgers Cooperative Research & Extension. 2003. Lead Contaminated Soil: Minimizing Health Risks, Rutgers Cooperative Research and Extension, The State University of New Jersey, New Brunswick, August 2003.
- Schaner, J.J., Lough, G.C., Shafer, M.M., Christensen, W., et.al. 2006. Characterization of Metals Emitted from Motor Vehicles. The Health Effects Institute, Report 133, Charlestown Navy Yard, Boston, MA 02129. April 2006
- Smith, A.H., Lopipero P., 2001. Evaluation of the Toxicity of Dioxins and Dioxin-like PCBs: A Health Risk Appraisal for the New Zealand Population. Ministry for the Environment, Wellington. ISBN 0-478-09091-9. February 2001.
- The Macaulay Land Use Research Institute. 2005. Trends in Pollution of Scottish Soils, Transects – 1990. Aberdeen, AB158QH UK 2005. <http://www.macaulay.ac.uk/tipss/lead/htm>
- Tisa, K., 2006. The TSCA PCB Regulations Post-1998. Powerpoint Presentation to the Licensed Site Professional Association, United States Environmental Protection Agency, Boston, MA. 2006.
- Tucker, M.R., Hardy, D.H., Stokes. C.E. 2005: Heavy Metals in North Carolina Soils: Occurrence and Significance. North Carolina Department of Agriculture and Consumer Services, Agronomic Division, Raleigh, North Carolina, Revised October 2005.
- USEPA (U.S. Environmental Protection Agency). 1990. Guidance on Remedial Actions for Superfund Sites with PCB Contamination. Office of Emergency and Remedial Response. EPA/540/G-90/007. August 1990.
- USEPA (U.S. Environmental Protection Agency). 2004a. Exposure and Human Health Reassessment of 2,3,7,8-Tetrachlorodibenzo-*p*-Dioxin (TCDD) and Related Compounds National Academy Sciences (NAS) Review Draft. October 2004.
- USEPA (U.S. Environmental Protection Agency). 2004b. Region 9 Preliminary Remediation Goals 2004 Table. <http://www.epa.gov/region9/waste/sfund/prg/index.html>
- USEPA (U.S. Environmental Protection Agency). 2005a. Supplemental Guidance for Assessing Susceptibility from Early Life Exposures to Carcinogens. EPA/630/R-03/003F. March.
- USEPA (U.S. Environmental Protection Agency). 2005b. Polychlorinated Biphenyl (PCB) Site Revitalization Guidance Under the Toxic Substances Control Act (TSCA), OPPT -2004-0123, November 2005.
- USEPA (U.S. Environmental Protection Agency). 2006a. Integrated Risk Information System (IRIS). Online toxicity database. Office of Research and Development, National Center for Environmental Assessment. Last updated on Wednesday, March 8th, 2006. URL: <http://www.epa.gov/iris/>

- USEPA (U.S. Environmental Protection Agency). 2006b. Dioxin: Frequently Asked Questions (FAQs). National Center for Environmental Assessment.
- USEPA (U.S. Environmental Protection Agency). 2006c. Region III Risk-Based Concentration Table. Updated April 2006. <http://www.epa.gov/reg3hwmd/risk/human/index.htm>.
- Visher, J., 1999. Japan's New Dioxin Standards, From the Mainichi: Shimban, November 5, 1999. <http://lists.essential.org/dioxin-1/thrd14.html>

PART V: Heavy Metals

Chapter 9

NEW APPROACH TO INACTIVE LANDFILLS CONTAINING WASTES OF MERCURY AND OTHER HEAVY METALS

Jan Jaremski

Rzeszow University of Technology, ul. W. Pola 2, 35-959 Rzeszow, Poland

Abstract: This article presents an analysis of some of the complex problems connected with old closed landfills in Poland, illustrated by examples from several municipal and industrial sites. These landfills have been usually closed prior to any assessment of the filtrating abilities of the layers below the bottom or of the layers directly surrounding the waste sites. Typically, there has been no analysis of the physical and chemical properties of the soil, microstructure, and so on. Technical solutions intended to maximize the possible stoppage of impurities in the inactive landfills are proposed. Such solutions reduce the influence of impurities on the geological environment by separating them from environment using special cavity walls which act as screens against filtration. Known protection methods must be constantly improved, and some waste materials will remain in the disposal sites up to the moment of the application of new remediation techniques. Co-disposal of hazardous and municipal wastes merits special analysis. The monitoring of changes in the chemical composition of waste mass during bioremediation is critical.

Key words: mercury, landfill, bioremediation, soil, groundwater.

1. INTRODUCTION

It is necessary to change the approach to closed landfills containing municipal and industrial waste materials. Previously, these two kinds of waste materials were typically, and unsuitably, deposited together. Later, new techniques of waste neutralization, segregation and recycling were introduced. Nowadays, waste disposal sites are bioreactors using biorecovery, physical, chemical and other processes, depending on percentage of municipal waste. At the landfills, liquid and gaseous impurities occur, and it is often difficult to predict their occurrence.

It is not easy to protect the geological environment around the old inactive waste disposal sites. In practice, a partial intake of leachate is usually done, and the deposited waste materials are covered with a layer of cohesive soil and sealing foil. Gases formed during biorecovery usually pass into the atmosphere. Critically, many landfills are located in closed-down strip mines (marls, aggregate and so on). Filtrating eluvia or permeable non-cohesive soils often occur below the bottom of the landfills. Some waste material was usually deposited below the underground water level. Tests of leachate in the closed-down landfills should be treated as a separate problem and cannot be the only source of analysis of these landfills. Inventory of the old waste disposal sites is essential since the deposited toxic substances need to be balanced. An inactive landfill is a bioreactor so chemical reactions taking

place within can be difficult to assess. Formed products sometimes prove more toxic than the deposited substrates (Lewis, 1992). In many cases, interdisciplinary analysis of biorecovery products as well as physical and chemical processes occurring in the landfills is recommended. Considerations presented in this paper connected with the deposit of waste materials containing mercury show the scope of the problem. As does the evaluation of the risk of impurities caused by the heavy metals and toxic substances found in many waste disposal sites (Komatina and Komatina, 1994).

This paper presents analysis of some complex problems connected with old landfills, illustrated by several examples. Generally speaking, these landfills have been usually capped without any assessment of the filtrating abilities of the layers below the landfill bottom and/or the layers directly surrounding the waste. Typically, no analysis of the physical or chemical properties of the soil, microstructure etc has taken place. Control of the waste disposal sites would include only tests of the composition of leachate (randomly drawn). The time of sampling is not related to remediation intensity and sampling frequency is usually not established. In general, waste composition is not analyzed, and the percentage of the deposited waste coming from local industry remains unknown.

Technical solutions intending to maximize the possible stoppage of impurities in the inactive landfills are proposed. Such solutions allow for the reduction of the influence of impurities on the geological environment, by separating the impurities from the environment using special cavity (screens against filtration) walls. In the case of permeable soils below the landfill bottom, it is possible to stop vertical filtration through the formation of an impermeable horizontal layer deep below the bottom of the landfill. These protections are expensive, but these costs should be compared to accrued costs resulting from the lack of protection, i.e. damage to the environment and local community. Known methods must be constantly be improved, and waste materials should be contained within the disposal sites up until the moment of the application of new remediation techniques.

Development of new research methods for trace chemistry will extend the catalogue of toxic chemistry (Dybczynski at al., 1990; Theis, 1988) and the list of applications of impurity migration models. New research will also enhance techniques for parameters allowing for the calculation of diffusion, dispersion, degradation and sorption of impurities through geological and geotechnical barriers. Assessment of leak tightness of packages between the landfill bottom and the underground water level is also critical. Previous papers, (Jaremski, 1994; Jaremski, 2000) have outlined methods used to determine the leak tightness of laminar foundation through the identification of nitric compounds and organic carbon. These methods can be useful during assessment of leak tightness for landfills with complicated hydrogeological conditions pertaining as a result of previous volcano phenomena and earth movements which result in faults and dislocations joining the existing water-bearing levels.

2. PROBLEM OF MERCURY IN CASE OF THE RZESZOW LANDFILL

The town of Rzeszow and its closed landfills are located in area of the Przedkarpacka Pradolina (Piedmont region). This primeval valley was created by the erosion of post-glacial waters and was filled with pleistocene and holocene sediments. The old landfill is situated within the excavations of a closed clay mine. There are 7,5m deep silty clays mined as raw material for a brickyard. Under the clays, are interbeddings of clayey gravel with rounded rock fragments. This layer is some 5 meters deep and its range is unknown. Such subsoil makes up a geological barrier of questionable quality. The landfill does not have additional sealing and has not operated since 1990. About 2621550m³ municipal and industrial wastes were deposited there during nine years of operation (1982-1990). The waste disposal site area was about 3 ha. While operating, ground glass breakage from RZLW "Polam" factory was deposited there. These glass wastes from discharge lamps production contained dangerous levels of mercury. Assuming the minimum estimated amounts of mercury in the wastes (Jaremski, 2006), we can say that about 2680 kg of mercury were deposited.

Landfilling of mercury wastes together with the organic mass of Rzeszow municipal wastes made the biomethylation of heavy metal possible. Biomethylation is a process in which microbes present

during bioremediation in deposited waste mass, change inorganic forms of mercury into metalloorganic forms. During methylation the microbes transfer the alkyl group to the metal, forming connections $(\text{CH}_3)_2\text{Hg}$, $(\text{CH}_3)\text{Hg}^+$. Mechanisms of alkylation are not yet well known. However, it is clear that the methylation proceeds very efficiently under the oxygen-free conditions occurring in those landfills which contain wastes having putrescible organic matter. The methylmercury forms are much more toxic than the metallic mercury (Eccles and Aman, 1987) as can be seen from the tragic death of chemistry professor, Karen Wetterhahn, who died after a 15-second contact with some millilitres methylmercury absorbed through a latex glove barrier (Gulanowska and Cieslak-Golonka, 1998). Methylmercury $(\text{CH}_3)\text{Hg}^+$ is readily soluble in water and has bioaccumulative properties, whereas dimethylmercury $(\text{CH}_3)_2\text{Hg}$ is sparingly soluble in water but quite volatile. Methylmercury and ethylmercury connections are resistant to biochemical degradation processes. Vapours of mercury and methylmercury are the most harmful because they easily penetrate to the brain. Constant contact with high concentrations of mercury causes injuries of the nervous system, kidneys and fetus. Permissible dosages of mercury have been determined, but tolerance limits for low concentrations are not precisely known (Friberg and Vostal, 1972; D'Itri and D'Itri, 1977).

The results of process of biomethylation in the disposal sites of municipal wastes confirmed Lindberg's investigations (Raloff, 2001). Steve E. Lindberg and his coworkers found methylmercury in the water vapor that condensed out of the gas emanating from a Florida landfill. Concentrations were at least 100 times of those typically seen in water. However, methylmercury comes in two forms - mono- and dimethylmercury - with the latter being the more toxic. To probe which form is made in landfills, Lindberg and his research group collected gases destined for flaring. They reported finding some 50 nanograms of dimethylmercury per cubic of landfill gas.

It should be noted that mercuric wastes were deposited in many landfills in the Rzeszow region where the main reservoir of groundwater, satisfying the requirements of drinking water, is located (Jaremski, 2002). It must also be noted that the released compounds of the deposited mercury can be transported through the great depths of soil and for great distances (USEPA, 1997).

3. LANDFILLS OF SOME WASTES OF CHEMICAL INDUSTRY

In an urban agglomeration in the south of Poland, unique groundwaters occurring in the Trias shell limestone, had to be protected against pollution caused by heavy metals, such as highly toxic compounds of barium released from the old industrial waste landfills (Jaremski, 1990). The waste disposal site location, occupying about 34 ha., was considered more than adequate 75 years ago when the chemical plant started operation, during which time roughly 850 000 m³ of wastes containing heavy metals were deposited.

The landfills under consideration occupy a large area on the quaternary cohesive grounds above the clay aluvium and the Trias sediments. They are located within one of the biggest reservoir of groundwater in Poland. It can be characterized by a relatively low degree of reduction of impurities. The surface is protected by the clay grounds only in some areas. The supply of the Trias water-bearing reservoir is done on the outcrops or indirectly by the quaternary level. At the disposal site area, the Trias formations are supplied by the infiltration of precipitation waters and by waters occurring in the quaternary formations through discontinuities of the impermeable layers, including filtrating layers and slightly permeable layers such as silts, sand and silty clays, as well as eluvia of the Trias formations. In the area of the waste disposal site, there are filtration paths to the Trias water-bearing layers caused by mining actions, or by dislocations formed during tectonic movements in the Tertiary period. Water occurring in the Trias shell limestone is of a very good quality. Reserves of those water-bearing formations are drawn for production of drinking water for a big city and the capacity is estimated for more than 200 000 m³/d. The depression funnel, formed as a result of the water drawing by the wells, causes an increase in the quaternary water drainage by the privileged filtration paths, as well as introducing waters to the Trias water-bearing layers polluted by heavy metals from the region's landfills

Content of the heavy metals was analyzed at the particular landfills. For instance, there are about of 2.5 millions of tons of zinc (6.36% – 17.02%). Not far from the considered waste disposal site zinc mines, of only 1% of zinc ores, were operated. Now the ores of 4% zinc are emerging. The zinc ore deposits are sufficient only for several years. Similarly, the copper content is from 3% to 10.8%. Recovery of these metals possibly using an electrolytic recovery method causes a radical increase in the profitability of proposed waste treatment as raw materials. Recovery of other elements has been deemed unprofitable due to too low content and too high technological costs. From the preliminary analyses, it appears that we should expect very high profits for the recovered zinc and copper. Assuming unfavorable market conditions, the proposed solution would allow for repayment of the cost of the proposal realization.

4. CONCEPTION OF LANDFILLS PROTECTION

Old landfills containing different wastes (a mix of municipal and hazardous industrial wastes) should be treated as a dangerous bioremediator, in which very toxic and active compounds can form as products. In the author's opinion, all the old waste disposal sites must be treated as sources of dangerous impurities and should be covered by suitable geotechnical barriers with installations for gas driving. These installations should make gas combustion possible. Gas products from the old landfill sites should not be carried to atmosphere but rather such low energy value substances should be burned using fuel gas. Mercury can be removed from gases with use of the Medisorbon process, applied for mercury removal from waste gases.

In order to protect the hydrogeological environment, encasing the Rzeszow waste disposal site with a screen against filtration together with a diaphragm to protect against ionic diffusion should be considered. Such protection effective if there is an impermeable layer under the given area. The landfill site area should be separated by the screen, i.e. a deep diaphragm reaching the cohesive soil layer and satisfying requirements as for the filtration coefficient. The screen should be done as a cavity wall in thixotropic suspension and with an additional membrane. Such screen should be 15-17 m in height. It would protect the geological environment against ionic diffusion and heavy metal washing out from industrial wastes. This solution should prevent the penetration of hazardous wastes into groundwater. Such separated area including all the deposited wastes would become a bioremediator (Jaremski, 2003). Infiltrating water from precipitations will be intaken by wells (Fig.1).

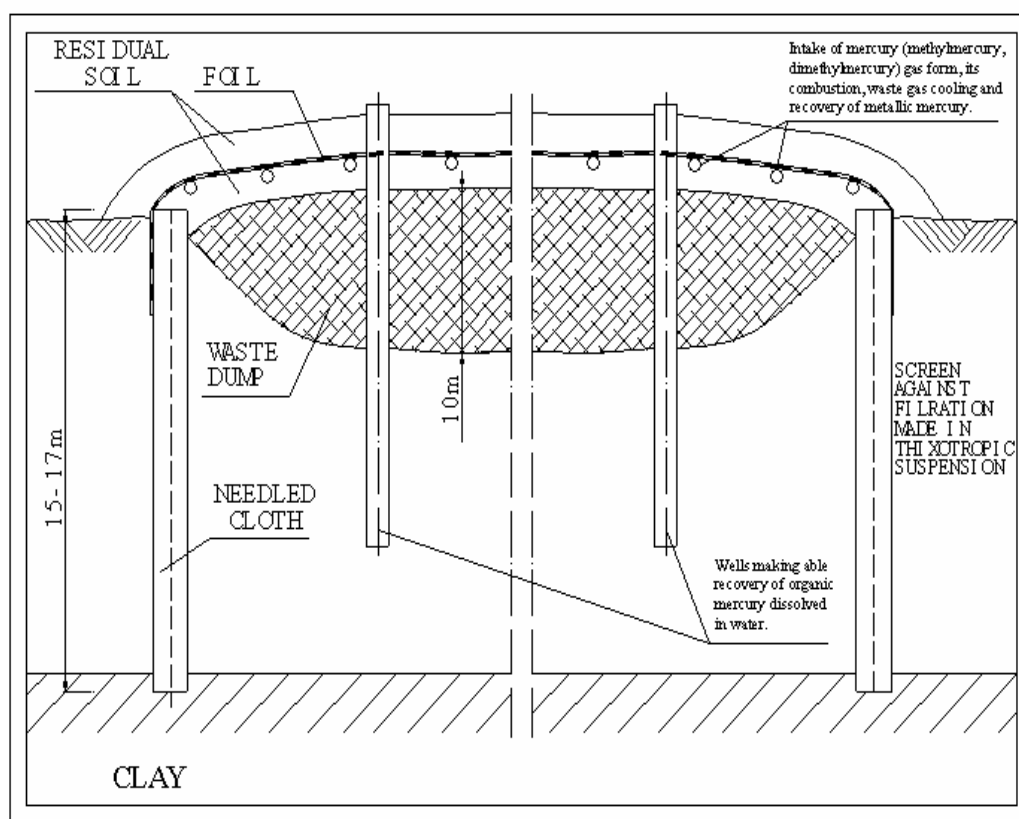

Figure 1. Scheme of the proposed protection of the Rzeszow waste disposal site

In examining the problems incurred by the industrial waste landfills presented in Chapter 3, the author have also considered the possibility of the creation of a bioremediator which would separate the waste disposal site by the screen which would reach the layer of protected Trias shell limestone or the upper packages of eluvia thus protecting against filtration. The floor of quaternary formations (belonging to the holocene and the Pleistocene eras), would determine the depth of the screen in many landfills. According to the preliminary settlements, it is located from 10 m to 16 m, and in some disposal sites from 5 m to 25 m. In the considered area, the wastes contain heavy metals so they are very dangerous for the Trias waters. At present, the area of the water pollution is limited to the north part of the Trias water basin. Moreover, we do not know the exact volume of the layer where the impurities are accumulated. The authors suggests making the screen as a cavity wall in the thixotropic suspension with the built-in additional membrane protecting the geological environment before ionic diffusion and before the migration of dangerous impurities from the industrial wastes to the waters occurring in the shell limestone. The proposed bioremediator seems to be the most reasonable solution for now, which would allow the investigation of particular landfills to determine their future. (They can be treated as a place for raw materials or as a place for wastes only). Further operation of the wastes as raw materials needs to included some additional tests on their composition and the geological environment. Selection of a suitable location for the protecting screen must be preceded by analysis of the geological conditions of the landfill adjacent areas, where bioremediation would be realized with use of some selected bacterial strains capable of accumulation of heavy metals (Fijałkowska et al., 2000).

5. CONCLUSIONS

In case of old closed landfills, located in piedmont region of Poland, it is possible that impurities from this disposal site will migrate to mineral drinking water resources through unprotected layer of

gravel. The landfills are located in place of complicated hydrogeological conditions of which the systems of subsoil cracks and faults is currently little understood. The cost of isolation between the landfill and filtrating layers as well as leachate intake is minimal in relation to prospective hazards for hydrogeological environment and such a precious water resource. Co-disposal of hazardous and municipal wastes demands a special analysis. Monitoring of changes in chemical composition of wastes mass during bioremediation is critical.

There are many problems connected with industrial waste landfills. Specialists in many fields must work together on the problem solving. In many countries the wastes must be treated as raw materials but creating adequate protocols is extremely complex. It is not easy to make the decision whether or not to utilize the wastes.

The existing landfills for industrial wastes located in areas in the proglacial stream valleys, sometimes in the excavations of the closed strip mines of mineral raw materials, require special treatment and special solutions. Under the storage bottom, we can often meet non-cohesive soils or rock eluvia of good filtrating properties. It is necessary to formulate a quantity criterion for waste deposits depending on the local hydrogeological conditions, and to eliminate waste disposal sites in proglacial stream valleys where rivers flow at present.

The problems connected with inactive landfills of industrial and industrial-municipal wastes are interdisciplinary and they need systematic scientific work, including analyses of the influence of the deposited toxic substances on the geological environment, and the time changes of sorption capacity of particular ground layers existing under the landfill bottom.

REFERENCES

- D'Itri, P.A., and D'Itri, F.M. 1977. *Mercury Contamination: A Human Tragedy*. John Wiley, New York.
- Dybczynski, R, et al. 1990. A comprehensive study on the contents and leaching of trace elements from fly-ash originating from Polish Hard Coal by NAA and AAS methods. *Biol. Elem. Resc.* 26, pp.65-73. PUB-SET, INC.
- Eccles, C. U., and Aman, Z., eds. 1987. *The Toxicity of Methylmercury*. The John Hopkins University, the Press of Baltimore.
- Fijałkowska, S., Schmauder, H.P., Długoński, J. 2000. Microbial and plant action on heavy metals removal from soil contaminated by post floatation tailings from metal works. *Scientific Books of Silesian Technical University. Z.45*, pp.24-31. Gliwice.
- Friberg, L., and Vostal, J. 1972. *Mercury in the Environment*. CRC Press, Cleveland, Ohio.
- Gulanowska, B., Cieslak-Golonka, M. 1998. Karen E. Wetterhahn (1948-1997). *Orbital* 1.
- Jaremski, J. 1990. The analysis of influence waste from power station deposited in the open casts the composition of ground water. *Proc. of 6th Int. Cong. IAEG*, pp. 1895-1901. Amsterdam, A.A.Balkema.
- Jaremski, J. 1994. Some aspects of waste deposit in the marl open-air casts. *Proc. of 7th Int. Cong. IAEG*, pp.2969-2978. Lisboa.
- Jaremski, J. 2000. Some criteria for waste depositing in excavations. *Proc. of 8th Int. Cong. IAEG*, pp.4551-4556. Vancouver, A.A.Balkema.
- Jaremski, J. 2002. Protection of the geological environment, especially ground water, against the influence of contaminants from waste materials containing heavy metals. *Proc. of 9th Int. Cong. IAEG*, pp. 1560-1565. Durban, South Africa.
- Jaremski, J. 2003. Some results of bioremediation in waste yards and their influence on the contaminated soils. *Proc. of Int. Conf. on Problematic Soils*, pp. 291-294. Nottingham, United Kingdom.
- Jaremski, J. 2006. Issues of dissipated mercury wastes. *5th ICEG Environmental Geotechnics*, pp. 1410-1414. Thomas Telford, London.
- Komatina, M., Komatina, S. 1994. Geological criterion for toxic waste disposal site selection. *Proc. of 7th Int. Cong. IAEG*, pp.2565-2567. Lisboa, A.A. Balkema.
- Lewis, R.J. 1992. *Sax's Dangerous Properties of Industrial Materials*. 8th edition, Van Nostrand-Reinhold, DSM 450.
- Raloff, J. 2001. Dimethylmercury in Landfills. *Science News Week of July, 7*, Vol. 160.
- Theis, T.I. 1988. Physical and chemical characteristics of unsaturated pore water and leachate at a dray fly ash disposal site. *Proc. of 43rd. Ind. Waste Conf.*, pp.161-172. Purd. Univ. West, Laf., Indiana, Lewis Publishers, INC.
- USEPA (U.S. Environmental Protection Agency). 1997. *Mercury Study Report to Congress*. Office of Air Quality Planning and Standards, Office of Research and Development. EPA-452/R-97-005. December 1997.

Chapter 10

INVESTIGATION OF THE USE OF MINE TAILINGS FOR UNPAVED ROAD BASE CONSTRUCTION

Ali A. Mahmood¹ and Catherine N. Mulligan²

¹Graduate Student, Department of Building Civil and Environmental Engrg., Concordia University, EV 6.139, 1515 Ste-Catherine St. W., Montreal, Quebec, Canada, H3G 2W1, Tel. (514) 8482424 ext. (7227), Email: ali_002000@yahoo.ca;

²Associate Professor, Department of Building Civil and Environmental Engrg., Concordia University, S-EV 6.187, 1515 Ste-Catherine St. W., Montreal, Quebec, Canada, H3G 2W1.

Abstract: Tailings have been traditionally stored in ponds surrounded by tailings dams for many years but since many accidents, including fatal ones, took place that involved tailings dams, a new approach has become necessary for their storage. An approach devised by Robinsky in the early 1970s for the storage and disposal of mine tailings suggests that it is more advantageous environmentally to strengthen the tailings before disposal. This work attempts to emphasize this point by seeking to explore the possibility of using these hardened tailings as base materials for the construction of unpaved (temporary access) roads. Six different types of tailings that represent a cross section from several mines in eastern Canada are used and preliminary physical characteristics tests were performed followed by unconfined compressive testing. Initial results indicate that the tailings sustained more than the minimum amount of stress normally required for filling stopes and the layer coefficients determined for five of the tailings used match reasonably well with values from ten United States state departments of transportation.

Key words: tailings, Portland cement, heavy metals, unconfined compression.

1. INTRODUCTION

Tailings are the waste materials (byproducts) of the mining industry. Tailings contain all other constituents of the ore but the extracted metal, among them heavy metals and other toxic substances that are either added to the tailings in the milling process or available with the ore before that (ICOLD 2003).

Most mill tailings mass-produced worldwide are dumped in large surface impoundments (tailings dams). The embankments forming these impoundments are earth fill dams. Over the years these earth fill dams have had several serious spilling problems, some even fatal. Two recent examples of the disasters originating from tailings dams spilling are one, the Merriespruit dam tailings failure that resulted in the killing of 17 people and caused extensive damage to a residential township in South Africa in 1994 (Fourie and Papageorgiou 2001 and Fourie et al. 2001). Another disaster occurred in the Philippines in 2002 where tailings spilled into Mapanuepe Lake and eventually into the Saint Tomas River. Low lying villages were flooded with mine waste. At least 250 families were evacuated from that area, (Fahey et al. 2002).

Hence it was necessary to devise another approach for the storage and disposal of mine tailings with the aim of eliminating the hazards and risks associated with mine tailings dams. Research on mine tailings stems from the necessity to prevent the danger posed by mine tailings to the environment. This danger is characterized by the tendency of mine tailings to release acids and heavy metals once in contact with oxygen and water, (Gautam et al. 2000). In 1978 Robinsky published what was probably the first detailed paper suggesting that tailings could be economically disposed of

after being extensively dewatered (Robinsky 1978). He suggested the word 'thickened tailings' and even produced a schematic showing the development of a conical deposit of high-density tailings (Fourie 2002).

2. PREVIOUS RESEARCH

2.1 Tailings Thickening

Robinsky proposed the thickened tailings disposal system for the disposal of mine tailings (Robinsky 1978). He showed that by the process of thickening the tailings to heavy slurry prior to disposal, it is possible to create a self supporting deposit of tailings and to eliminate the typical superimposed settling pond.

Robinsky (1978) stated that the inherent problems associated with the operation of conventional tailings disposal schemes are eliminated using this new technique. Some of the obvious problems that are eliminated or at least much reduced are:

- Danger of failure of steep-sided tailings dams caused by earth tremors, blasting vibrations, or movement of heavy machinery;
- Erosion and undermining of the dams by seepage from the raised slimes pond in the center of the tailings deposit;
- Infiltration of undesirable tailings fluid into the underlying natural soil deposits from the liquid pond on top of the tailings; and commencement of reclamation only after mine closure.

The elimination of the conventional pond on top of the deposit also provides a major environmental advantage; the hydrostatic head that causes seepage of process and rainwater to occur through conventionally deposited tailings is eliminated. Another very important environmental advantage is that the confining dam(s) are eliminated, or, at least, reduced substantially in height which will also reduce or eliminate the problems of aging of tailings dams (Murray et al. 2000 and Vanicek 2002). Finally, the adoption of the system may permit progressive reclamation in some topographical settings.

Several research attempts followed the first mine tailings thickening paper of Robinsky with the aim of enhancing this new idea by adding a binder or other agents to the thickened tailings. An example is the work by Zou and Li (1999) who investigated direct solidification and strengthening of dilute tailings slurry. Two types of tailings were tested at water/binder ratios of up to 4.5 using special high-water binder. The main objective of their research was to develop a backfill technology that can use the total tailings and will be applicable to all types of tailings without the expensive dewatering process. These results proved that the high water tailings slurry could be solidified directly and was able to develop sufficiently high early strength and that it is possible to use the dilute total tailings slurry without the dewatering process in backfill.

The thickened surface tailings disposal concept has been applied at various mining operations for several decades, including the Kidd Creek Mine in northern Ontario and for managing the disposal of red muds produced by the alumina industry (Robinsky 1999).

Although the concept of tailings thickening is relatively new, soil stabilization techniques using cement and lime have been applied for many years now. Hilt and Davidson (1960) discussed lime fixation in clays heralding a decade of advancing technology in lime and Portland cement stabilization of clay soils (Petry and Little 2002). Prusinski (Little et al. 2000) states that since 1915 more than 140,000 km of equivalent 7.5 m wide pavement bases had been constructed from cement-stabilized soils. Cement has been found effective in stabilizing a wide variety of soils, including granular materials, silts and clays (Petry and Little 2002). The following works represent examples of using this concept in the mining industry and research:

Garand et al. (2000) described the effects of flocculent deposition of tailings sludge in the Bouchard-Hebert mine in northern Quebec. ASTM standard tests were performed on the tailings to characterize particle size, specific gravity and Atterberg limits. Then the tailings sludge was mechanically thickened in the paste backfill plant and a flocculent PERCOL E-10 is added to the

sludge before it is processed in the thickener. These flocs presented uniform apparent grain-size distribution larger than or similar to coarse silt. The authors concluded that the beaches formed with these flocs can be used as competent foundation material for upstream raises. Their study presented a modification on Robinsky's thickening principle by adding a flocculent to the tailings to enhance thickening and increase stability.

Demers and Haile (2003) described the stabilization of zinc tailings, called Jarosite. The Jarosite was thickened first using vacuum filters and then lime cement and water were added to the thickened Jarosite to make a product that was named Jarofix. Field tests were performed after the commissioning of the Jarofix process in October 1998, after which the authors concluded that Jarofix is chemically inert thus eliminating all short and long term environmental risks during and after its disposal and that it was a physically stable mass. It was also found that cured Jarofix was an excellent fill material for construction of dykes and roads (Demers and Haile 2003).

Benzaazoua et al. (2002) discussed in some detail the influence that several chemical factors have on the performance of mine sulphidic paste backfill. The authors attempted to investigate the effect of the chemical characteristics on the uniaxial compressive strength on these tailings backfill. It was found that the mixing water is an important parameter that affects the quality of the paste backfill and that slag based binder hydration seems to be inhibited by the presence of soluble sulphates in contrast to the Portland cement based binder. The results of this study clearly demonstrate the inefficiency of choosing paste backfill mixtures without testing first the tailings and mixing water characteristics (Benzaazoua et al. 2002).

2.2 Tailings Management

Nguyen and Boger (1998) described two case studies where the measurement and use of rheological properties have assisted in solving large-scale tailings disposal problems in the Australian mining and mineral industry. The results have been used to develop a new waste disposal strategy whereby many technical, economical and environmental problems associated with the current disposal technology can be minimized.

Another study was detailed by Theriault et al. (2003) describing the surface disposal of paste tailings at the Bulyanhulu Gold mine in Tanzania managed by a subsidiary of Barrick Gold Corporation. Some clear goals of this process were, as stated by the authors, to conserve water, manage runoff reduce risk and minimize containment dyke construction. The tailings slurry was thus dewatered and then transported to the paste plant where process water is added in the paste conditioner to produce a paste of the desired consistency. The authors ascertained that the cycling of the tailings deposition in thin layers has been successful in generating a stable paste stack. It was concluded that paste stack can be engineered to meet the required geotechnical and environmental objectives (Theriault et al. 2003).

Results presented herein are part of an ongoing research program into the behavior of solidified mine tailings with the aim of determining the applicability of the use of tailings as base materials for temporary access roads. This will be approached by determining the unconfined compressive strength of several mine tailings-binder combinations.

3. EXPERIMENTAL PROCEDURE

3.1 Tailings Characteristics

Bench scale and pilot tests carried out by Alcan International Ltd. on copper and gold tailings had shown the applicability of the thickening technology to a variety of tailings (Haile et al. 2000) in addition to the alumina tailings that were investigated by the latter authors. Therefore in this study, six different mine tailings (Mussel white tailings: Placer Dome mine: Musselwhite, Ontario, Noranda Tailings: Noranda Inc.: Brunswick mine, Bathurst, NB, Louvicourt tailings: Louvicourt Mine, Val. d'Or, Quebec, Golden Giant tailings: Newmont Canada Limited, Golden Giant Mine, Marathon

(Ontario), Mont Wright tailings: Quebec Cartier mineral company, Mont-Wright, Quebec and Copper tailings: Murdochville, Quebec) were selected and obtained to evaluate a wide range of tailings from different types of mines. Laboratory tests on these tailings were carried out and the measured properties of the tailings are presented below.

3.2 Particle Size Analysis

Representative samples from each tailings type were chosen after removing any unusually big chunks of tailings. Dry sieving was performed according to ASTM D 422 (1998) after oven drying these tailings specimens in an electric oven at 105°C for 24 hours.

Hydrometer analysis was performed in accordance with ASTM D422 (1998): 4% NaPO₃ (sodium hexametaphosphate) solution was made by mixing 20 g of the NaPO₃ powder with enough water to make 500 milliliters.

Initial moisture content for each type of tailings was determined as defined by ASTM D 2216 (1998) by taking representative samples from each tailings container. After determining their wet weight, these samples were placed in an oven at 105 °C for 24 hours, after which another weight measurement was taken. This procedure was continued until constant weight was achieved. Table 1 outlines the physical characteristics of these tailings where it can be seen that according to the Unified Soil Classification System (Das, 2000), Musslewhite, Louvicourt, Golden Giant and Copper tailings are classified as silty sands whereas Noranda tailings are considered well-graded sand with silt and Mont Wright tailings are poorly-graded sand.

3.3 Specific Gravity

Representative samples were obtained from each of the six tailings types. Then they were oven dried for 24 hours at 105°C prior to determining the specific gravity. Subsequently specific gravity tests were performed according to ASTM D 854 (1998). Distilled water was used for these tests and by gently rotating and agitating the flasks, it was assured that all air bubbles were eliminated from within these samples before taking the weight measurements. Weight determinations were made using an electronic balance sensitive to 0.01 g.

Table 2 details the specific gravities of the tailings samples considered at 20 °C and the standard deviations of the samples selected for all tailings with the exception of Mont Wright and Golden Giant. Bowles (1986) states that for specific gravities measuring between 2.4-3, another procedure for determining the acceptable accuracy of the measurements was to have two readings differ by no more than 2 percent. Both Mont Wright and Golden Giant fall into this criterion as shown in Table 2. All other tailings samples satisfy the criteria of having a maximum standard deviation of 0.021 according to ASTM D854 (1998). Specific gravity results were within the range presented by other researches; (Mittal and Morgenstern, 1975; Qiu and Sego, 2001; Garand et al., 2000; Haile et al., 2000; Demers and Haile, 2003; and Crowder et al., 2000).

Table 1. Physical properties of the tailings used.

| Type of tailings | Nor-anda | Mussle-white | Golden Giant | Louvi-court | Copper | Mont Wright |
|------------------------------|----------|--------------|--------------|-------------|--------|-------------|
| D ₁₀ (mm) | 0.063 | 0.0045 | 0.004 | 0.005 | 0.02 | 0.147 |
| D ₅₀ (mm) | 0.81 | 0.016 | 0.039 | 0.0464 | 0.0622 | 0.255 |
| D ₆₀ (mm) | 1.19 | 0.023 | 0.055 | 0.0697 | 0.0844 | 0.3 |
| D ₃₀ (mm) | 0.398 | 0.012 | 0.0178 | 0.018 | 0.04 | 0.2 |
| C _u | 18.89 | 5 | 13.75 | 13.94 | 4.22 | 2.04 |
| C _z | 2.11 | 1.39 | 1.44 | 0.93 | 0.948 | 0.91 |
| P _{4.75mm} (%) | 92 | 100 | 100 | 100 | 100 | 100 |
| P _{0.075mm} (%) | 8.59 | 74.9 | 69.69 | 62.05 | 56.9 | 2.05 |
| Initial moisture content (%) | 17.04 | 30.15 | 19.71 | 28.1 | 22.33 | 4.27 |
| USCS | SW-SM | SM | SM | SM | SM | SP |

D_{10} = diameter corresponding to 10% finer, D_{50} = diameter corresponding to 50% finer, D_{60} = diameter corresponding to 60% finer, D_{30} = diameter corresponding to 30% finer, C_u = uniformity coefficient = D_{60} / D_{10} , C_z = coefficient of gradation = $D_{30}^2 / (D_{10} D_{60})$, $P_{4.75\text{mm}}(\%)$ = percentage passing sieve no. 4, $P_{0.075\text{mm}}(\%)$ = percentage passing sieve no. 200.

Table 2. Specific Gravities of the tailings used.

| Tailings type | Specific Gravity | Standard Deviation |
|---------------|------------------|--------------------|
| Copper | 3.4 | 0.021 |
| Mont Wright | 2.76 | 1.004* |
| Noranda | 3.68 | 0.014 |
| Golden Giant | 2.97 | 1.01* |
| Mussle white | 3.26 | 0.0071 |
| Louvi court | 3.33 | 0.0071 |

3.4 Unconfined Compressive Testing

Determining the strength of the tailings block is the first part to ensuring that they are suitable environmentally for disposal and for construction of service roads and containment dykes thereafter.

Type I Ordinary Portland cement was mixed with each type of tailings using a mechanical mixer. This type of cement is usually the least expensive and the most commonly used in chemical fixation and solidification applications, (Conner, 1990). In general, Portland cement systems produce stronger matrices than other inorganic binder systems, and they do it at lower mix ratios, which results in a smaller volume of waste requiring ultimate disposal, (Weitzman et al., 1988). In these tests it was desired to determine the effect of the change in water content on the compressive strength. Cement content was maintained constant during these tests. Each mix was poured subsequently in three different wooden molds with dimensions of (2.5 X 2.5 X 2.5) centimeters. These mixes were then left to cure at room temperature for 24 hours before placing them in the moisture chamber.

A moisture chamber placed inside an incubator was utilized for the storage of the cured specimens. Temperature inside the chamber was maintained at 23.5°C and the humidity at 98% (Wang and Vipulanandan, 1996; Diez et al., 1997; Zamorani et al., 1989). Having a pool of water at the bottom of the chamber ensured that humidity was maintained at this prescribed level. Figure 1 shows the tailings specimens inside the moisture chamber. For each type of tailings, density was maintained uniform since this parameter had to be constant during compression testing.



Figure 1. Tailings specimens inside the moisture chamber

Unconfined compression testing was performed by subjecting the cubes to one dimensional compression from a Com-Ten Industries™ uniaxial machine with a peak compression force of 8.896 kN applying a constant speed of descent. The peak force and peak deflection maintained during each test were recorded and used subsequently in calculations.

The speed of descent of the platen was kept constant at an average of 70 mm/minute and the test was continued until visual observation of failure of the cube. After which the machine was cleaned and made ready for another test. A total of 180 compression tests were performed in the prescribed manner.

4. RESULTS AND DISCUSSION

Figure 2 shows the results of the tests performed. Stress measured in mega Pascals is plotted in this figure against water/cement ratios. The uniaxial (unconfined) compressive strength corresponds to the maximum stress value observed during the compression test.

When varying water/cement ratio it is seen through Figure 2 that all the tailings tested experienced a drastic decrease in stress with increasing water content. It can also be seen that when increasing the water content Louvicourt had the highest stress while Noranda sustained the lowest recorded stresses and all other tailings had intermediate stress values between these two.

4.1 Effect of Water Content

It is well known that strength decreases as matrix porosity increases, and that porosity increases as the water to cement ratio increases above an optimal value (Lea, 1971 and Neville, 1995). Figure 2 illustrates that strength decreases with increasing water content for Portland cement products containing metal contaminants. The same conclusion was reached by Stegemann (2001). The

correlation coefficient of these plots is not high and the scatter is obvious indicating that they are nonlinear.

4.2 Estimation of Interlaboratory Error

A quality program conducted by Stegemann et al. (2001) in which the products prepared by the University of Rome (Dall'Aglio et al., 2001), the University of Cantabria (Fernandez Olmo et al., 2001) and the University of Surrey (Gervais and Ouki, 2001 and Hills and Ouki, 1999) were each tested in all three laboratories. The unconfined compression strength results from the quality control program have been used to calculate a pooled variance, which corresponds to an interlaboratory standard deviation of 3430 kPa; measuring the UCS of separately prepared batches increased the interlaboratory standard deviation to 4120 kPa (Stegemann, 2001).

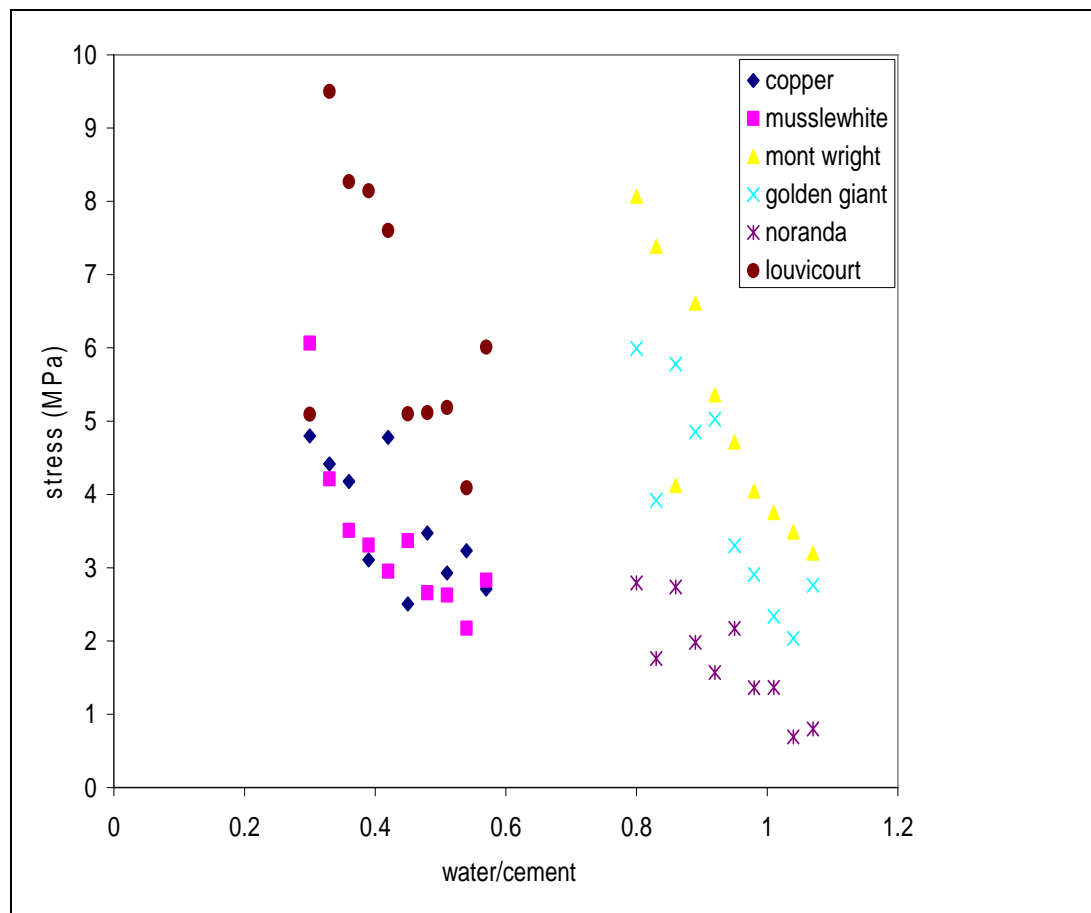

Figure 2. Stress versus water/cement ratio for all tailings

Neville (1995) also reports that for high strength concrete a typical intralaboratory standard deviation is in the range of 3500 to 5500 kPa. Table 3 shows the standard deviation range and variance for the unconfined compressive testing for the tailings considered in this study.

A comparison between the values of standard deviation reported in the literature and cited above and the values found in this work indicates that compression values for this study have much less variability and the scatter is typical for cement paste mortars and therefore could be considered accurate and applicable for design and calculation purposes.

4.3 Layer Coefficients

AASHTO highway design method requires knowledge of a structural number (SN), which is a function of several parameters including design traffic level, subgrade support, desired reliability and desired terminal serviceability, (AASHTO, 1986). The equation relating the structural number to the layer coefficients is the following:

$$SN = a_1 D_1 + m_2 a_2 D_2 + m_3 a_3 D_3$$

Where: SN = structural number; a_1, a_2, a_3 = layer coefficients for the surface, base and subbase, respectively; m_2, m_3 = drainage coefficients of the base and subbase, respectively; D_1, D_2, D_3 = thickness of the surface, base and subbase layers, respectively.

Hence it appears from the equation above that the thickness of any particular layer depends to a significant level on the layer coefficients. Thus in order to assess the suitability of the tailings for use in temporary access roads, an analysis was made to determine the layer coefficient for use when designing an access road with tailings as the base layer. Two different equations were used in this analysis; the first was developed by the University of Missouri-Rolla (Richardson, 1996):

$$E_c = 915.48 + 1314.9 q_u \dots\dots\dots(1)$$

Where E_c = Chord modulus of elasticity (MPa),
 q_u = the unconfined compressive strength (MPa).

And the second equation used was developed from data supplied by work performed by Felt and Abrams (1957), Reinhold (1955) and University of Missouri-Rolla (Richardson 1996);

$$E_c = -34.367 + 2006.8 (q_u)^{0.7784} \dots\dots\dots(2)$$

Then layer coefficients are computed by using the AASHTO nomograph. The equation for the relationship of layer coefficients and modulus was derived from the nomograph and is the following (Richardson, 1996):

$$a_2 = -2.7170 + 0.49711 \log E_c \dots\dots\dots(3)$$

Where a_2 = layer coefficient.

Figure 3 shows the layer coefficients for all tailings used. The coefficients for all tailings with the exception of Noranda at higher water contents, match reasonably well with values from 10 state departments of transportation reported in the literature, which range from 0.12 to 0.3 (ACI Committee, 1990), thus indicating that these mine tailings are suitable structurally for unpaved road construction. Layer coefficients for Noranda tailings with water contents more than 80% were lower than 0.12. These cubes had lower cohesion and faster disintegration when tested in compression. This could be due to higher sulphur content as indicated by the yellowish color of these hardened cubes.

Table 3. standard deviation range and variance for the unconfined compressive tests for all tailings used.

| Tailings type | Standard Deviation Range (kPa) | Variance |
|---------------|--------------------------------|-----------------------|
| Copper | 403-1461 | 162409-2134521 |
| Mont Wright | 247-1419 | 61009-2013561 |
| Noranda | 69.9-1289.7 | 4886.01-1663326.09 |
| Golden Giant | 187.9-1724.9 | 35306.41-2975280.01 |
| Musslewhite | 216.1-1795.1 | 46699.21-3222384.01 |
| Louvicourt | 445.6-3529.5 | 198559.36-12457370.25 |

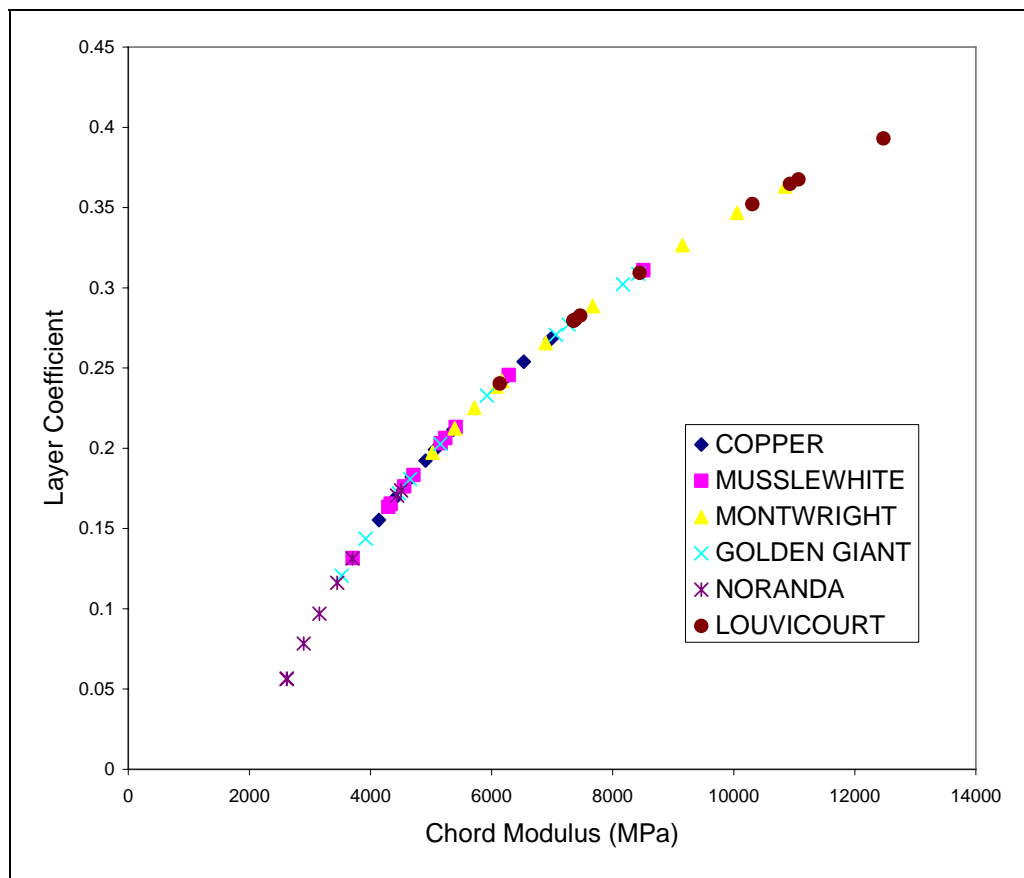

Figure 3. Layer Coefficients versus Chord Modulus for all tailings.

5. CONCLUSIONS

1. The values of the specific gravity of the tailings under study are within the typical ranges published for similar types of tailings.
2. All tailings considered exceeded the minimum limit required in strength for filling underground stopes.
3. Strength decreased as water/cement content increased for all tailings.
4. Unconfined compressive strength standard deviations for tailings specimens were lower than expected for cement paste mortars.
5. Layer coefficients determined suggest that all these tailings with the exception of Noranda can be suitable base materials structurally for building unpaved temporary access roads.

REFERENCES

- AASHTO (1986), Guide for design of pavement structures. American Association of State Highway and Transportation Officials (AASHTO), Washington, D.C.
- ACI Committee 230, (1990), State of the art report on soil cement, ACI Materials J., 87 (4), 395-417.
- ASTM D 422-63 (Reapproved 1998), Standard Test Method for Particle-Size Analysis of Soils, Annual Book of ASTM Standards, Volume 4.08, American Society for Testing and Materials, West Conshohocken, PA.
- ASTM D 854 (1998), Standard Test Method for Specific Gravity of Soils, Annual Book of ASTM Standards, Volume 4.08, American Society for Testing and Materials, West Conshohocken, PA.

- ASTM D 2216 (1998), Standard Test Method for Laboratory Determination of Water (Moisture) Content of Soil and Rock by Mass, Annual Book of ASTM Standards, Volume 4.08, American Society for Testing and Materials, West Conshohocken, PA.
- Benzaazoua, M., Belem, T., and Bussiere, B., (2002), Chemical factors that influence the performance of mine sulphidic paste backfill, *Cement and Concrete Research*, 32: 1133-1144.
- Bowles, Joseph E. (1986), *Engineering properties of soils and their measurement*, 3rd edition, McGraw-Hill book company, USA.
- Conner, Jesse (1990), *Chemical fixation and solidification of hazardous wastes*, Van Nostrand Reinhold, New York.
- Crowder, J.J., Grabinsky, M.W.F. and Landriault, D.A., (2000). Consolidation testing and S.E.M. images of tailings pastes for surface disposal. Proc., 53 Can. Geotech. Conf., Can. Geotech. Society, Montreal, Canada, pp. 625-632.
- Dall'Aglio, L., Polettini, A., Pomi, R. and Sirini, P. (2001), A fractional design to investigate on heavy metals and anions influence on cement hydration-Part 1-Physical and mechanical properties, submitted to *Environmental Science and Technology*.
- Das, Braja M., (2000), *Fundamentals of Geotechnical Engineering*, Brooks/Cole, a division of Thomas Learning™, CA, USA.
- Demers, B., and Haile, G., (2003), Management of tailings stabilized by lime and cement at Canadian electrolytic zinc, Valleyfield, Quebec, Proc. Sudbury 2003 Mining and the Environment, May 25-28, Sudbury, Ontario.
- Diez, J.M., Madrid, J. and Macias, A. (1997), Characterization of cement-stabilized Cd waste, *Cement Concrete Research*, Vol. 27, No.3, pp. 337-343.
- Fahey, M., Newson, T.A. and Fujiyasu, Y., (2002), Engineering with tailings, Proc., 4th International Conference on Environmental Geotechnics, Brazil, pp. 947-973.
- Felt, E.J., and Abrams, M.S. (1957), strength and elastic properties of compacted soil-cement mixtures, Bull. D16, Portland Cement Assoc. (PCA), Skokie, Ill., 26.
- Fernandez Olmo, I., Chacon, E. and Irabian, A. (2001) Influence of lead, Zinc, Iron (III) and Chromium (III) oxides on the setting time and strength development of Portland cement, submitted to *Cement and Concrete Research*, Manuscript 4400.
- Fourie, A.B., and Papageorgiou, G., (2001), Defining and appropriate steady state line for Merriespruit gold tailings, *Can Geotech. J.*, 38 (4), 695-706.
- Fourie, A.B., Blight, G.E., and Papageorgiou, G., (2001), Static liquefaction as a possible explanation for the Merriespruit tailings dam failure, *Can. Geotech. J.*, 38 (4), 707-719.
- Fourie, A.B., (2002), Thickened tailings: is it a revolution in the making, Proc., 4th International Conference on Environmental Geotechnics, Brazil, pp. 977-986.
- Garand, P., Vezina, S., and Bocking, K. (2000), Effects of flocculent on deposition of tailings sludge for upstream raise of impoundment dykes, Proc., 53 Can. Geotech. Conf., Can. Geotech. Society, Montreal, Canada, pp. 633-640.
- Gautam, R., Yanful, E.K. and Karamanev, D.G., (2000). "Laboratory scale sulphide tailings oxidation" Proc., 53 Can. Geotech. Conf., Can. Geotech. Society, Montreal, Canada, pp. 649-656.
- Gervais, C. and Ouki, SK. (2001), Performance study of cementitious systems containing zeolite and silica fume: Effects of 4 metal nitrates on the setting time, strength and leaching characteristics, submitted to *Journal of Hazardous Materials*, December 2001.
- Haile, G., O'Callaghan, W.B., Hartney, T.F., and Cameron, W., (2000), Experience with thickened red mud tailings (paste) stacking tropical and temperate climates and applicability of the technology to other tailings, Proc., 53 Can. Geotech. Conf., Can. Geotech. Society, Montreal, Canada.
- Hills, C.D. and Ouki, S.K. (1999), Microstructure of Portland cement pastes containing metal nitrate salts, waste stabilization and environment, 13-16 April, 1999, Lyon Villeurbanne, J. Mehu, G. Keck and A. Navarro, Eds. ISBN 2-905015-40-3, Societe Alpine de Publication, Grenoble, pp.225-254.
- Hilt, G.H., and Davidson, D.T. (1960), lime fixation in clayey soils, HRB Bulletin No. 262, Highway Research Board, National Research Council, Washington, D.C. 20-32.
- ICOLD (2003) International Commission on Large Dams report, 151, Boulevard Haussmann, 75008 Paris, France.
- Lea, F.M., (1971), *The Chemistry of Cement and Concrete*, Chemical Publishing Company, Inc. New York.
- Little, D.N., Males, E.H., Prusinski, J.R., and Stewart, B. (2000), Cementitious stabilization, 79th Millennium Rep. Series, Transportation Research Board, Washington, D.C.
- Mittal, H., and Morgenstern, N.R. (1975), Parameters for the design of tailings dams, *Can. Geotech. J.*, 12: 235-261.
- Murray, L., McLeod, H., and Plewes, H. (2000), Aging of tailings dams, Proc., 53 Can. Geotech. Conf., Can. Geotech. Society, Montreal, Canada.
- Neville, A.M. (1995), *Properties of Concrete*, Fourth and Final Edition, Longman Scientific and Technical, UK.
- Nguyen, Q.D. and Boger, D.V. (1998). Application of rheology to solving tailings disposal problems. *International Journal of Mineral Processing*, 54, 217-233.
- Petry, T.M. and Little, D.N., (2002), Review of stabilization of clays and expansive soils in pavements and lightly loaded structures-history, practice and future, *Journal of Materials in Civil Engineering*, Vol. 14, No.6, pp. 447-460.
- Qiu, Y., and Sego, D.C., (2001), Laboratory properties of mine tailings, *Can. Geotech. J.*, 38: 183-190.
- Reinhold, F., (1955), Elastic behavior of soil-cement mixtures, Bull. 108, Highway Research Board, Washington, D.C., 128-137.

- Richardson, D.N., (1996), AASHTO layer coefficients for cement-stabilized soil bases, *Journal of Materials in Civil Engrg.*, Vol. 8, No.2, pp. 83-87.
- Robinsky, E. (1978), Tailings disposal by the thickened discharge method for improved economy and environmental control, *Tailings Disposal Today, Proc.*, 2nd Int. Symp., 75-95.
- Robinsky, E.I. (1999). Tailing dam failures need not be disasters- The Thickened Tailings Disposal (TTD) system" E.I. Robinsky Associates Ltd., *CIM Bulletin*, 92 (1028), 140-142, Toronto, Ontario.
- Stegemann, J.A. (2001), *Neural Network Analysis of The Effects of Contaminants on Properties of Cement Pastes*, PhD Thesis, Imperial College of Science, Technology and Medicine, London, UK.
- Stegemann, J.A., Butcher, E.J., Irabien, A., Johnston, P., de Miguel, R., Ouki, S.K., Poletini, A. and Sassaroli, G., Eds. (2001), *Neural Network Analysis for Prediction of Interactions in Cement/Waste Systems - Final Report*, Commission of the European Community, Brussels, Belgium, Contract No. BRPR-CT97-0570.
- Theriault, J.A., Frostiak, J., and Welch, D., (2003), Surface disposal of paste tailings at the Bulyanhulu gold mine, Tanzania, *Proc. Sudbury 2003 Mining and the Environment*, May 25-28, Sudbury, Ontario.
- Vanicek, I. (2002), Tailings dams- practical problems of aging, *Proc.*, 4th International Conference on Environmental Geotechnics, Brazil, pp. 301-304.
- Wang, S.Y. and Vipulanandan, C. (1996), Leachability of lead from solidified cement-fly ash binders, *Cement and Concrete Research*, Vol. 26, pp. 895-905.
- Weitzman, L., Hamel, L.E. and Barth, E., (1988), Evaluation of solidification/stabilization as best demonstrated available technology, in *Proc. 14th Annual Research Symposium*, U.S. EPA, Cincinnati, Ohio.
- Zamorani, E., Sheikh, I. and Serrini, G. (1989), A study of the influence of nickel chloride on the physical characteristics and leachability of Portland cement, *Cement and Concrete Research*, Vol. 19, pp. 259-266.
- Zou, D.H. and Li, L.P. (1999), "Strengthening of solidified dilute tailings slurry", *Journal of Geotech. and Geoenviron. Engrg.*, ASCE, 125 (1), 11-15.

Chapter 11

SITES IN THE REPUBLIC OF SLOVENIA POLLUTED BY HEAVY METALS: STRATEGY AND ACTIONS PLANNED IN THE AREA

Branko Druzina¹ and Andrej Perc²

¹University College for Health Care, University of Ljubljana, Slovenia; ²E-NET Environment, Ljubljana, Slovenia

Abstract: In the Republic of Slovenia there are five large sites polluted with heavy metals. The largest one is the waste disposal site of a lead and zinc mine in the northern part of the country, Next in size is the waste and tailings disposal site of the world's second largest mercury mine. Both mines are now closed. The other three sites are smaller than those described above. They are as follows: the tailings disposal site of a uranium mine; the waste disposal site of an ironworks; and the waste disposal site of an aluminum processing plant. The article will present up-to-date data on the quantities of disposed wastes as well as measurements of some parameters connected with harmful effects on the environment and human health. Hazardous heavy metals from mines are monitored in the soil, flowing waters, groundwater and in the air. In some cases they are also monitored in some vegetables and human tissues and organs. The results of blood analysis for the content of heavy metals for mine workers and general population will be presented for two mining towns. On the largest sites, i.e. the waste disposal site of the lead and zinc mine and the waste disposal site of the mercury mine, some remediation activities are in progress. The results will be presented in graphs and tables.

Key words: Republic of Slovenia, heavy metals, polluted sites, disposed waste, measurements.

1. INTRODUCTION

In the Republic of Slovenia, with a surface area of over 20,000 km², there are five larger sites with increased levels of heavy metal pollution. This condition is the result of heavy metal mines or heavy metal processing at all five sites as follows: the waste disposal site of the lead and zinc mine at Mezica; the waste and tailings disposal site of the mercury mine in Idrija; the tailings disposal site of the uranium mine at Zirovski Vrh; the waste disposal site of the Jesenice ironworks; and the waste disposal site of the aluminium processing plant in Kidricevo.

In addition to these sites, there are another ten disposal sites containing waste from industries that are partly unregulated and represent a severe burden for the environment. These waste disposal sites are filled with various kinds of waste materials originating from various industrial branches. In these waste disposal sites measurements of leaching and measurements of emissions into the air are performed. In Slovenia, there is only one regulated active waste disposal site of harmful and hazardous waste materials. This is Metava in Maribor.

In addition to the active waste disposal sites there exists also a series of waste disposal sites that have arisen because of inadequate disposal of waste materials from industry in the period from 1950 to 1990. These waste disposal sites are: the disposal sites of acid tar in Pesnica, Studenci and Bohova near Maribor; the disposal site of industrial waste materials Globovnik near Ilirska Bistrica; the disposal site of red mud and ashes from the aluminium processing plant in Kidricevo; the disposal site of waste casting sands in Crnomelj, the area contaminated with PCB (polychlorinated biphenyls) in the surroundings of Semic.

This article presents data on the quantity of disposed waste at these sites, heavy metal concentrations in the waste, migration of these metals into the environment and the detected harmful

effects on humans. Values of individual monitoring parameters measured in each of these components of the environment are presented in the form of tables. The evaluation of values of the measured parameters corresponds to the maximum allowable quantities of these substances in the environment according to Slovenian legislation.

2. FIVE SITES POLLUTED WITH HEAVY METALS

The five sites polluted with heavy metals – Figure 1 – developed through the long centuries or decades respectively of the operation of mines and/or metal foundries: The mercury mine in Idrija operated for more than 500 years, the zinc and lead mine in Mežica for more than 300 years, the ironworks in Jesenica for more than 200 years. Therefore there are several disposal sites around these locations. In the past, the dumping of waste materials was spontaneous and occurred where some land was at disposal. The five disposal sites were unregulated and unprotected. With meteoric water metals washed away from the tailings and wastes, today it is recognized that a huge quantity of mercury from the disposal site of tailings near the the mercury mine in Idrija has migrated to the Adriatic Sea.

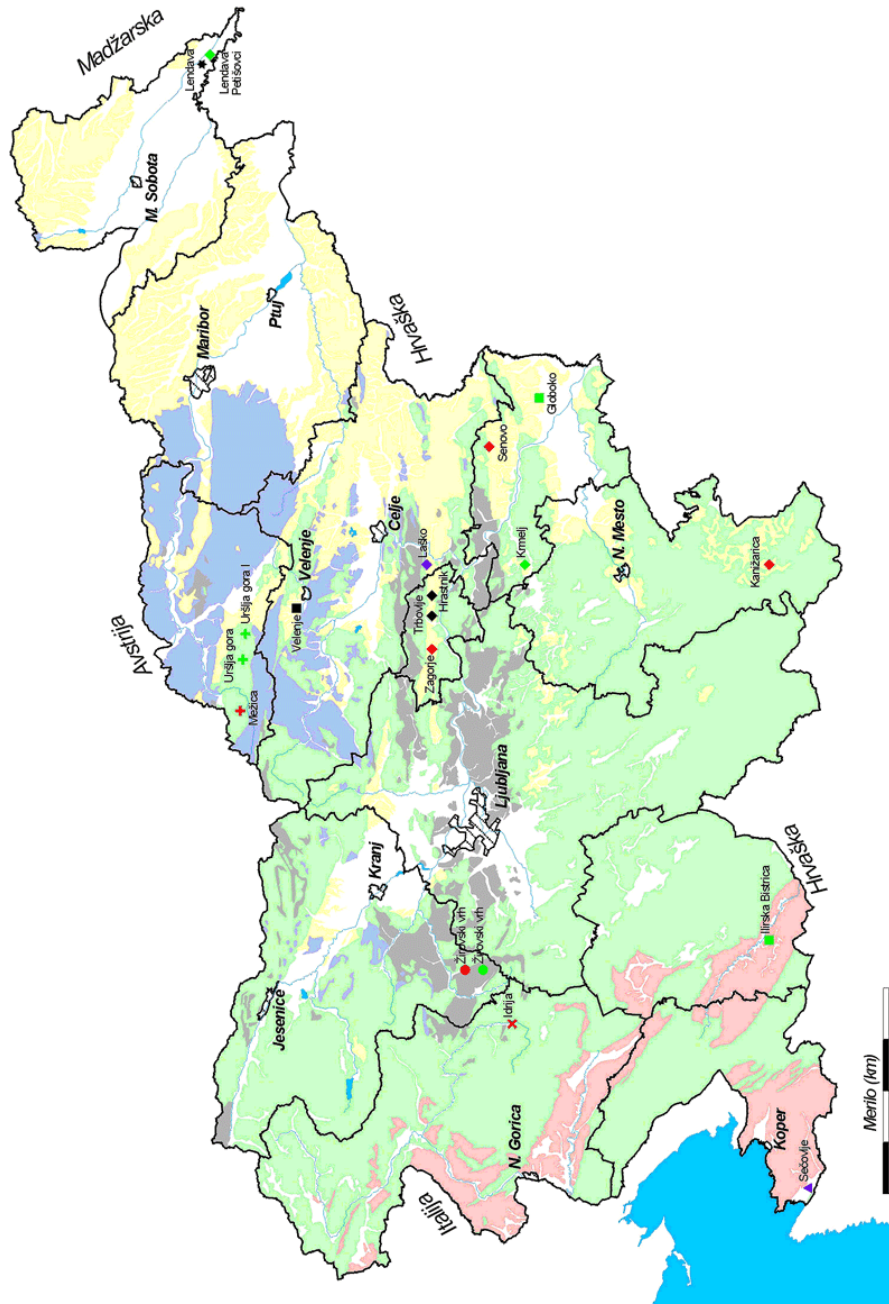

Figure 1. The five sites polluted with heavy metals

2.1 Waste Disposal Site of the Lead and Zinc Mine at Mezica

Tailing dumps represent a great burden for the environment because of their number and size. Tailing was dumped into valleys and partly on the slopes in the vicinity of the mine.

These tailing dumps are not planned; there are 31 of them in the mine area, spreading over 100 km². The estimated amount of tailing is around 20 million tons; the dump area is around 400,000 m². The tailing represents carbon material (mainly limestone and dolomite) with traces of ore and metal remains – the lead content is up to 3.8 %, zinc from 0.65 % to 7.7 %. The dump area is full of water, with numerous streams and springs, and even drinking water sources, as is evident from Table 1 (Presecnik, 2003).

The content of heavy metals in mine-waste landfills is continuously measured in tailings and leachate, and the content of natural radionuclides are periodically checked in tailings (uranium, radium, thorium).

At the Mezica mine, waste was created at first only because of extraction and the processing of ore in the smelting plant. After 1965, waste was also created as a result of the manufacturing of lead used in lead batteries. After 1989, the creation of waste was only the result of processing secondary materials.

According to Slovenian legislation, waste is dangerous if the values of zinc exceed 10,000 mg/kg; that is why seven of the old dumps are categorized as dumps with hazardous waste, and it is thus necessary to analyze out-going fluids constantly. According to data about the production of refined lead and the amount of created waste (scoria, gypsum, brick, hard rubber which amounts to about 5,763 tons of waste from 15,000 tons of pure lead) in the old dumps, it was calculated to be about 20 millions tons of waste

At that time, tailings were used for several purposes. Because of the appropriate grange and structure of the material, people removed it and used it for filling up sinking in the mine or even in construction of residential housing, for maintaining roads, etc. Usage of this material was the cause for analyses of contamination by natural radionuclides. Due to the dolomite basis, the content of radionuclides in tailings is relatively low, as shown in Table 2.

Table 1. Zinc content in old dumps in the mine area

| Name | % Lead | % Zinc |
|------------------------------|--------|--------|
| Zerjavaska halda | 0.85 | 3.24 |
| Stoparjeva halda | 0.80 | 2.86 |
| Andrejeva in Lukrecija halda | 0.66 | 0.56 |
| Halda na Zackovih peskih | 3.84 | 7.67 |
| Hildegardina halda | 1.12 | 4.45 |
| Terezija halda | 1.95 | 3.96 |
| Terezija podkop halda | 1.95 | 3.96 |
| Srce halda | 1.35 | 3.17 |
| Fridrih halda | 1.0 | 2.0 |
| Igrceva halda | 1.0 | 2.0 |
| Kavsakova halda | 0.15 | 0.65 |

Table 2. Content of radionuclides in tailings

| Location | ²²⁶ Ra (Bq/kg) | ²³⁸ U (Bq/kg) | ²³² Th (Bq/kg) | ⁴⁰ K (Bq/kg) |
|----------------------|---------------------------|--------------------------|---------------------------|-------------------------|
| Separation Zerjav | 10 | 10 | 1-3 | 10 |
| Tailing Kavsak | 10 | 10 | 1-3 | 10 |
| Pit Topla below Peca | 30 | 30 | 4 | 74 |
| Scoria from Zerjav | 6 | 6 | 2.8 | 25 |

2.2 Rehabilitation Program for Closure of the Mezica Mine

With the adoption of the Gradual Mine Closure Act (the Act Ensuring Part of the Funds Necessary for the Gradual Closure of the Mežica Lead and Zinc Mine, Official Gazette of the Republic of Slovenia No 5/88) mining operations started to be wound up. At the end of 1994 the last wagons of ore were brought from the mine for separation. As part of the closure, remediation programmes were drawn up for restoration of areas where residues from ore smelting had been deposited and where mine tailings had been dumped. One of the major remediation projects was the rehabilitation of the silt that had been released into the Meza River upon separation of the ore. In the 1980s the introduction of rehabilitation measures saw the start of silt disposal in abandoned parts of the mine. The remediation projects can be divided into three areas:

- rehabilitation of gangue heaps and landslips,
- protection of drinking water sources,

- correctly and safely arranged disposal of mine waste.

Gangue heaps are areas where mine tailings and residues from the separation process have been deposited. Remediation provided drainage of these areas and recultivation (planting and fences) with the planting of various plant species that should prevent erosion and the threat of tailings landslips. Problems arise primarily where people have located residential buildings or gardens and they cannot be systematically recultivated using one single methodology. There the tailings are flushed out by meteoric water, and this allows heavy metals to migrate into the groundwater. A full remediation of the existing gangue heaps and tailings dumps will also cover the preparation of new disposal sites and the transfer of the tailings together with the polluted ground from the old sites to a new one.

The remediation of drinking water sources served to protect accesses to potable water. The realistic prospects of rehabilitation in terms of protecting groundwater constitute primarily the covering of disposal sites, providing for the capture of underground water and the capture and treatment of leach water. Control and maintenance of these elements must also be carried out after recultivation of the disposal sites and gangue heaps.

The greatest difficulties are involved in the rehabilitation of wastes, both those from the pit and those left from ore smelting. In the production of 15,000 tons of lead, around 5,700 tons of waste is generated. A landfill site has been constructed for this waste.

2.3 Waste and tailings disposal site of the mercury mine in Idrija

The mercury mine in Idrija belongs to the greatest Hg mines in the world. Some 70 % of the ore is cinnabar and 30 % is native mercury. In the past the content of mercury in the ore was essentially higher. The greatest production, 820 tons of mercury, was reached in 1913. In the past the yield of winning was low, up to 75 % till 1948 and approximately 90 % after 1961. The burnt cinnabar was disposed near the devices. During a period of 500 years, over 12 mio tons of the ore were dug up and 153,000 tons of mercury were won, out of which 4,500 tons have contaminated the environment between Idria and the Gulf of Trieste (Dizdarevič, 2001). During the operation of the mine the emissions in the atmosphere were approximately 7 to 10 tons yearly. During the operation of the mine in the seventies the concentrations in the air were very high. They decreased, however, at the time of reduced operation, and today they are increased only at the mine ventilators and heaps of tailings. In the soil in the area of Idrija the concentration of mercury is very high (Gosar et al. 1997). The mine waters, rich in mercury, flew into the river Idrijca, and increased concentrations of iron and sulphate as a result of burning the ore are visible in the river Idrijca still today. Thus, the mercury in the river Idrijca is a result of the atmospheric deposition, sweeping away the soil and erosion of burnt remainders of the ore, which is reflected in high concentrations in the river, river sediments and the Gulf of Trieste. At the moment the mine is in the final phase of closing. (As the five hundredth anniversary of operation approached, the mine of Idrija, just when experiencing the greatest extension and technological and economical top, came to a crisis: with the awaked ecological consciousness in the world omitting of heavy metals and their replacement with substances more friendly to the environment and human being was started.) The procedure for closing the mine started in 1996 and it will definitely be completed in 2006.

The procedure for closing works can be divided into three steps:

1. Filling of mine objects (galleries, shafts, gravity-feed pipes, working sites given up) with pneumatic dyke and the use of lean concrete.
2. Injecting of inaccessible areas of old ore bodies. If necessary, also inaccessible galleries and blind shafts are injected with a special injecting mass. Reinforcing of coagulated dykes and destroyed stoneware by injecting is technically-technologically and also financially a very demanding part of closing the mine of Idrija. In 1991 a test-injecting on the third floor was performed. The injecting blend. 44 % of electro-filter ashes, 6 % of lime and 50 % of water. With this blend the required hardness (2 Mpa) was exceeded. Because of green movement protests against using electro-filter ashes, the composition of the blend was changed to 40 % of grounding dust of dolomite meal, 20 % of cement and 40 % of water. Up until the end of

1997, 8,620.95 m of injecting boreholes were made in 11,194.00 m³ of injecting mass were pushed into them.

3. In the final step, single floors are gradually poured with water under constant control of the closing works.

In 1995 the production of ore in the mine and its processing in the smelter was stopped. The standpoint was adopted that the separation and one rotation furnace would be preserved as a monument while other objects would be destroyed and the place ecologically remedied. In order to prevent the evaporation of mercury the complete area was covered with a one-meter layer of uncontaminated material. A landfill for the ecologically most polluted material was arranged on the lower part of the chimney stack. The bottom of the landfill was covered with a layer of clay and a drainage for meteoric waters was made. 7,180 m³ of material polluted with native mercury was put into the landfill and covered with 710 m³ of humus.

Although at the time of active mining of Hg in Idrija emissions of Hg into the environment were great, there are not many data on the past contamination at disposal. Systematic investigations of the influence of Hg on the environment have been started only in the last ten years. Before, the main concern was above all the protection of miners and inhabitants of Idrija from toxic action of Hg vapours. In this period two workshops were organized on the subject Hg in Idrija and the articles were published in two collections of scientific papers (Miklavcic, 1999). In our presentation we wish to summarize in short some important results of the investigations in the recent years.

2.3.1 River transport – entry of Hg into the rivers and sea

The hydrology of the Idrijca and Soca river and of the Gulf of Trieste is important for understanding the transport and distribution of mercury in the river basin and the gulf. The quantity of atmospheric precipitations in the river basin of the Idrijca and Soca rivers is high and varies strongly. Due to the configuration of the area the erosion is rather great; however, the transport of particles is limited because of the dams on the Soca river (Doblar, Plave, Solkan) – Figure 2.

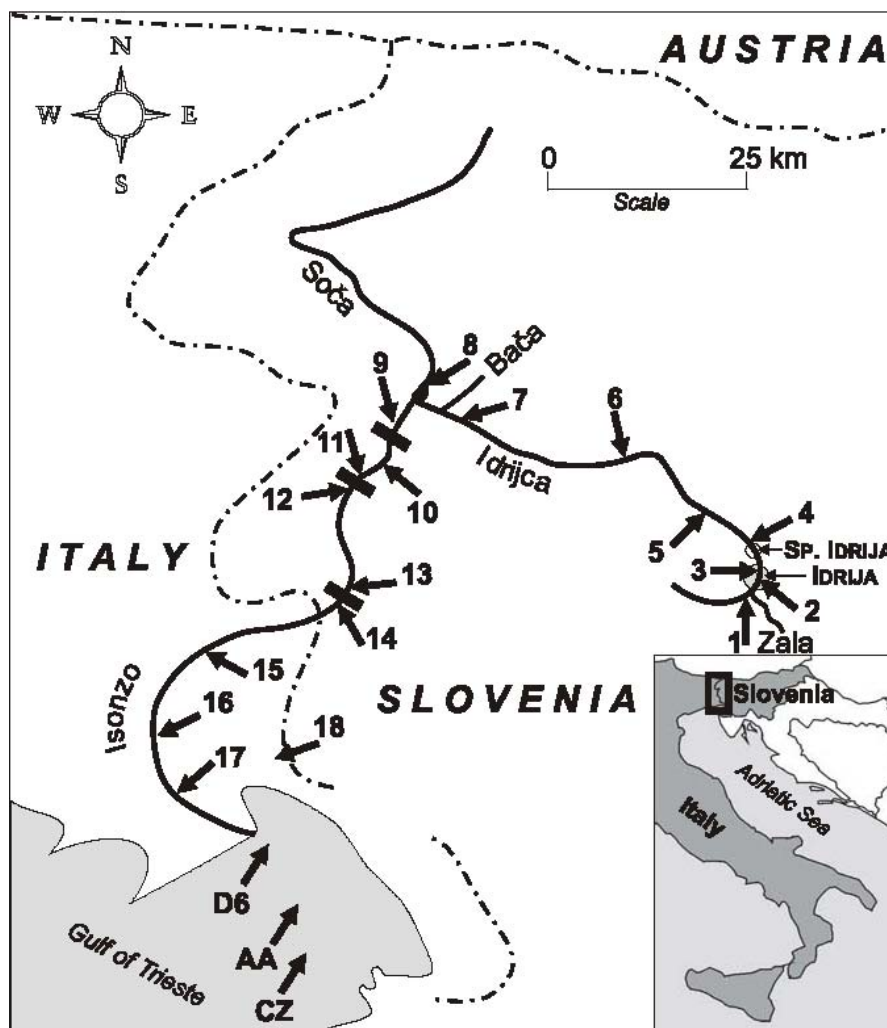

Figure 2. Leaching of Hg from disposal sites of the mercury mine in Idrija and migrating of Hg to Adriatic Sea

The hydrology of the Soca river is well known on the Slovenian side (Solkan) with the average overflow of some $100 \text{ m}^3/\text{s}$ with two expressive seasonal peaks: the longer one in the spring because of melting of snow in the Alps, and the shorter but stronger one, due to atmospheric precipitation, in the autumn.

In 2003 a repeated assessment of the transport of the suspended material and mercury in the river system Idrija/Soca was made that took into account the average seasonal flows and extreme phenomena. It is known that the majority of mercury is transported with the suspended material in the time of extremely high flows, which, as a rule, occur in this river basin at least once a year.

Detailed estimations of the definite entry of Hg into the Gulf of Trieste are uncertain and most probably underestimated. For instance, from the date of 1997 for the 5-year period of waters the estimation of the average entry of the suspended materials amounted up to $365 \text{ g}/\text{m}^3$, while the data from year 2002 for the measurements made at the time of moderate and low waters show variations between 4.6 and $20.3 \text{ g}/\text{m}^3$. On the basis of all the data known up till now the quantity of yearly entry of suspended materials into the Gulf of Trieste from the Soca is estimated to 150,000 tons.

After 1990 some measurements of Hg in water, both the dissolved and bound share, were made. Concentrations of monomethyl mercury, which is the most important form of Hg as regards the environmental and sanitary aspects, were also measured. The measurements have confirmed the fact that the largest quantities of Hg are transported with suspended particles. The measurements show a great variability of Hg concentrations, which is connected with the flow, hydrometeorologic parameters and sites. The Hg values mentioned in several reports and between <10 and up to $80 \text{ mg}/\text{kg}$ of the suspended material. In 2002, when systematic measurements in moderate and low

waters were carried out, the values varied between 1 and 4.5 mg/kg of sediment. The share of the methylated Hg is 0.2 to 3 % of the total Hg. The quantity of the average yearly entry of Hg over the Idrija river is 1500 kg. Anyway, it should be mentioned that occurrences of extreme events (large flood waves) can be essentially more fatal. Namely in a period of 5- to 10-year waters, great quantities of Hg can enter the waters, as was the case in November 1997, when at the time of the flood wave in the course of 8 days, the river Soca brought 4700 kg of mercury into the Gulf of Trieste.

Transport with the Soca is the far most important transport into the gulf. It makes 1.5 ton yearly, out of which 99.5 % is in a suspended form. The dissolved methyl mercury represents only 1.5 % of the total dissolved mercury in the transport. The great majority of the mercury brought in settles at the bottom of the Gulf of Trieste and remains there durably deposited (Operative program, 2004). An important result of the assessment of the mass balance indicates especially that the Soca is the main source of the anorganic mercury, while the main source of MeHg in the Gulf of Trieste is the sediment.

2.4 Remediation Program for Closure of the Idrija Mercury Mine

In 1987, a decision was adopted on the closure and the complete and permanent cessation of production at the Idrija mine. At the same time a decision was adopted regarding rehabilitation of the consequences of mining operations. Upon the decision being taken, a plan was drawn up in the same year for the conversion of part of the Idrija pit for tourism purposes. In view of the geological make-up of this area, the Idrija pit is separated into lower and upper sections. The lower section is composed of hard sedimentary rock. Owing to settling and surface slides above the upper section of the pit, which was caused by many years of intensive excavation, reinforcement works are being carried out – infilling of all pit levels in permocarbon shale, infilling of all shafts in this part of the pit, shoring up of uncompromised dykes by injection, filling the empty spaces above the dykes and injecting of destroyed mine pillars between excavations.

The urban area of Idrija is characterised by its mining history. Ore was smelted on the surrounding slopes, and the yield from this process was in the majority of cases below 50 %. The residues of smelting were dumped in the direct vicinity of the location where the heating and smelting of ore was carried out. The locations of unsmelted residues of rock and ore became mixed with the smelted residues. Thus there are known to be residues that in individual locations contain more than 80 tons of mercury. In the past these residues were used to build up first the immediate surroundings of the smelters and in this way the necessary work surfaces were created. Later various unwanted holes and morphological anomalies in the area of the town and its immediate surroundings were filled in. The dumping of smelter residues in the area of the town continued even in the 1950's and up to 1960. Owing precisely to the use of smelting residues as road-building base and aggregate, residues containing Hg are now found spread over a very wide area.

2.5 Tailings disposal site of the uranium mine at Zirovski Vrh

In Slovenia there are four locations where radioactive waste is disposed. This waste has been generated chiefly by the research, healthcare and industrial activities. The waste is kept in temporary storage facilities, whose technical features are not appropriate for the storage of the type of waste deposited. The largest volume of waste was generated primarily by a uranium mine and coal-fired power station (coal, ash) and aluminium processing plant. These locations are in the vicinity of Zirovski Vrh (uranium mine); Sostanj (coal-fired power station); Kidricevo (aluminium processing plant); and Kocevje (from other origins).

Slovenia used to have active uranium mine – Zirovski Vrh; it is now in the phase of closure and remediation of the landfill. There are now two landfills for radioactive waste from past mining activities and the processing of uranium ore:

- The first contains tailings produced in the uranium ore processing plant. This landfill covers an area of 4 hectares and contains around 600,000 tonnes of material containing 80 g U_3O_8 /t and 8.6 Bq/kg Ra-226,

- The second contains waste with red mud from ore processing. It contains around 1,500,000 tonnes of material with an average content of 70 g U_3O_8/t and total radioactivity of 15,200 GBq.

Radioactive waste is also produced by other industrial activities, primarily certain non-uranium mines, coal-fired power stations (coal ash), and aluminium and phosphate factories. This waste contains uranium and thorium levels higher than natural concentrations in the environment. These landfills are located in Sostanj, Kidricevo and Kocevje, and each covers several hectares. All five radioactive waste landfills, including those from non-uranium industrial sectors, are shown in Figure 3.

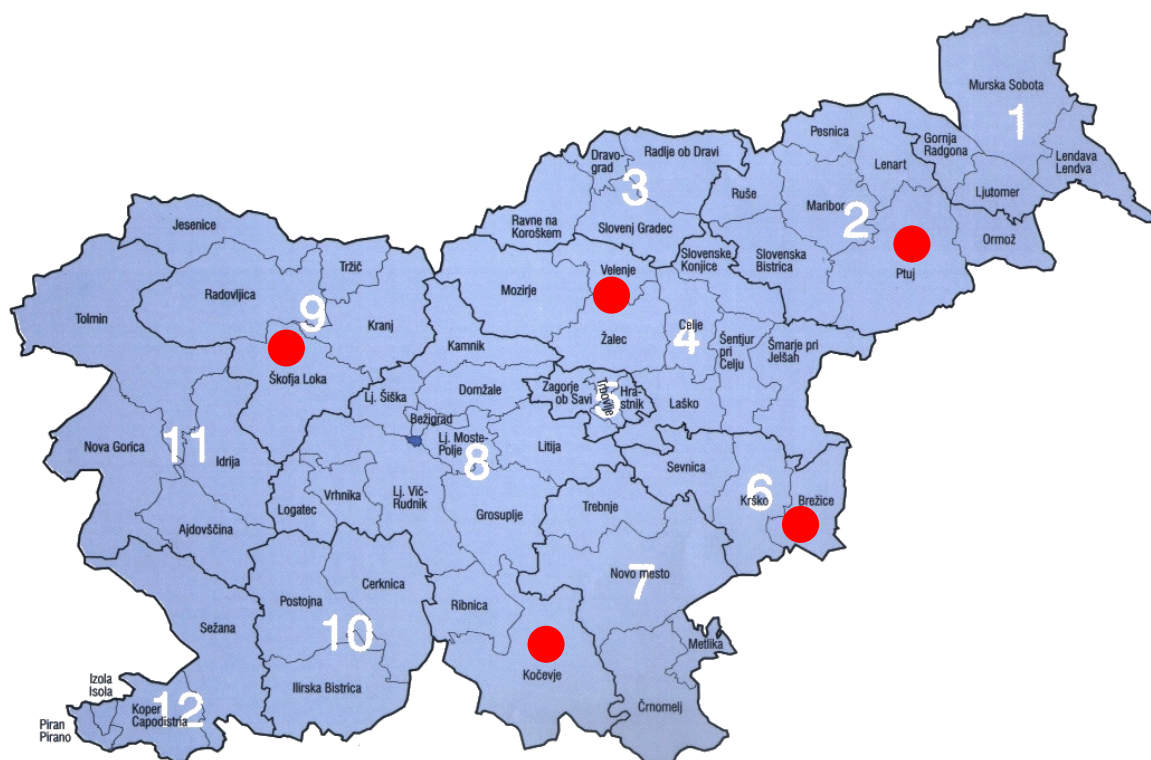

Figure 3. Shows the locations listed above.

2.6 Remediation Program for Closure of the Zirovski vrh Uranium Mine

The plan for the permanent arrangement of the tailings site of mine gangue envisages the transformation of the tailings body, primarily reducing the inclines, in order to increase the stability of slopes and reduce erosion. All surfaces will be covered with a suitable selection of grass. Emissions of radon and the intrusion of water into the tailings will be prevented through the installation of several layers of covering made from natural materials. The total thickness of the layers will be around 2 m. The project prioritizes natural materials and native plants, since they are more durable in the long term. A rainwater drainage system through channels will remove surface water in a controlled manner. A peripheral channel will protect the tailings from the threat of flood water. The Jazbec stream, which represents the biggest flooding threat, will be redirected along a new course around the tailings. Rainwater creates a groundwater stream in the tailings that for the most part flows out via a system of drainage pipes into a settlement pond, where it is cleared and also partly cleaned of uranium. Part of the groundwater stream that is not provided with a drainage system to the settlement pond flows out through drainage laid along the bottom of the infilled little valley and at the bottom of the gangue heap it flows into the stream. Another part of the groundwater stream, however, flows through a fissure in the rock base of the tailings and infiltrates the groundwater in the rock base,

thereby polluting it. This groundwater stream flows through a system of fissures into small springs and ponds below the tailings and above the Todrac stream.

As we have already mentioned, special attention was paid to stabilization of the subsidence 50 m deep under the tailings. Around 7 million tons have slowly slipped down the lateral slide plate at a speed of less than 1 mm a day. Construction of wells and a tunnel with two shafts has achieved adequate stability.

The plan for the permanent arrangement of the tailings site of hydrometallurgical gangue envisages the transformation of the tailings site, especially a visible reduction of inclines towards the north and west. This will increase the stability of the slopes and reduce the threat of erosion. All surfaces will be covered with a suitable selection of grass. Emissions of radon and the intrusion of water into the tailings will be prevented through the installation of several layers of covering made from natural materials, with a total thickness of around 2 m. The project prioritises natural materials and native plants, since they are more durable in the long term. A rainwater drainage system through channels will remove surface water in a controlled manner. A peripheral channel will protect the tailings from the threat of water. The course of the nearby stream will be regulated by reinforced banks in order to prevent any erosion of the ground towards the tailings.

The only anticipated environmental impact from the pit structure after its closure will be the water flowing from the pit. Concentrations of uranium will be below the permitted and authorised value of 0.25 mgU/L, and the activity of radium-226 will be below 60 Bq/m³.

After execution of the closure works, the tailings will affect the surroundings by air and water. By covering the material, the speed of the gamma radiation dose will be practically reduced to the level of the surroundings, i.e. below 0.15 µGy/h. Emissions of radon-222 through the surface of the tailings will be a source of environmental impact via the atmosphere. The speed of emissions will be below 0.1 Bq/m²s. This permitted limit value was established by the Slovenian Health Inspectorate. Owing to the reduced intrusion of surface water into the tailings, there will be reduced contamination of intrusion water and in particular reduced outflow. The permitted limit values are below 0.51 mgU/l for uranium and below 40 Bq/m³ for radium-226.

The impact of the Borst gangue heap on the surroundings via the atmosphere will be less than that of the Jazbec tailings. The reason for this is the higher situation of the Borst tailings above the temperature inversion boundary. Following installation of the covering, emissions of radon-222 will be below 0.7 Bq/m²s. By covering the material, the speed of the gamma radiation dose will be practically reduced to the level of the surroundings. The covering will also prevent the intrusion of rain and surface water into the tailings and the leaching of contaminants from the tailings. Gradually the outflow of drainage water will be reduced and stopped.

Taking into account all sources and paths of impact, the annual effective dose for critical population groups will be below 0.3 mSv, and probably between 0.1 and 0.2 mSv. For inhabitants further away in the Sora valley it will of course be even less, once all the envisaged mine closure works have been completed.

2.7 Waste disposal site of the Jesenice ironworks

The iron industry in Jesenice goes back to 1530: The first smeltery was opened in 1868. Since then, the smeltery waste (scoriae) has been deposited in the immediate vicinity of the foundry. The present state is alarming because all heavy metals are washed away into the underground water. The floor, where the waste was been deposited, is contaminated with antimony, copper, zinc, chrome, manganese, lead and dioxins.

At the time of greatest production, the foundry deposited some 10,000 tons of scoriae every year; scoriae are actually inert, the only problem are heavy metals. It was estimated that on the disposal sites in the surroundings of ironworks there are some 1,600,000 tons of waste from ironworks.

The present needs for the disposal sites are some 250,000 tons for the coming years of operating of the smeltery and rolling mill. It is foreseen that yearly some 8700 m³ of place would be needed.



Figure 4. Shows disposal site of the Jesenice ironworks

2.8 Remediation Plan of Waste Disposal Site of the Jesenice Ironworks

According to the local authorities the plan of remediation was made long years ago. Main activities in this plan are: monitoring of leaching water from disposal site, cleaning of leaching water before releasing in the river, monitoring of soil (periodically) and to set grass and some other plants on the site. Although the ironworks is due to lead remediation in reasonable period that are many problems with timing. The reason is a lack of money.

2.9 Waste Disposal Site of the Aluminum Processing Plant in Kidricevo

The building of the aluminum processing plant in Kidricevo was started in 1942 during the Second World War. In 1954 the trial production of the plant for the production of metallurgic bauxite was started, and at the end of the same year also the aluminum processing plant. Production increased annually and with it waste materials, both gaseous and solid, that were deposited on the disposal site inside the factory. The total production of metallurgic bauxite till 1991, when this plant was closed, amounted to some 3.4 mio tons. The total production of aluminum from 1955 to 2004 was slightly less than 2.6 mio tons.

During the described production a great number of waste materials were created. The following represent the greatest burden on the environment:

- fluorides - approx. 1,150 tons yearly,
- tar – approx. 90 tons yearly,
- remainders of cathodes - approx 2,500 tons yearly, and
- tailings of the bauxite ore, from which aluminum was leached – red mud - - 140,000 to 170,000 tons yearly.

Ash represents a special inert waste, namely as an energy supplier coal was used for years and 60,000 to 70,000 tons of ash were produced yearly. Since 1991 approx. 6.5 mio tons of red mud have

been produced. This mud contains alkaline metals. It is deposited on a disposal site of some 42 hectares (1 ha is 10,000 m²). The alkaline metals were washed into the underground water and came so also in the sources of drinking water.

2.10 Remediation of Waste Disposal Site of the Aluminum Processing Plant in Kidricevo

In 1986 the expertise for remediation of the red mud disposal site was prepared and in 1991 trial remediation of the disposal site was started. The expertise showed that at the contact with the sandy floor the layer of red mud had penetrated half a meter deep and the ground got choked with mud. Thus, under the deposit site a layer was formed that has a very low permeability.

The trial surface was divided into four parts, in which four different kinds of revitalization were carried out. With revitalization they tried to limit the influence of red mud on the environment, namely dusting and first of all trickling of meteoric waters through the layers of red mud and herewith transporting of alkaline metals and other toxic compounds in the groundwater.

To the first part or field of 15,000 m², first uncontaminated soil was carted and uniformly distributed, and then some 3000 young trees were planted, Scotch pine, Austrian pine, common spruce, larch and maple.

On the second field of 10,000 m², 5000 m³ of coal ash was carted and grass was sowed on it. Measurements showed that in one year pH of the surface decreased from 9.9 to 8.5.

The third trial field of 10,000 m² was covered with grass. The fourth trial field, also 10,000 m² large, was covered with the mud from the purifying plant for waste technological and communal waters and sowed with grass.

The results of these trial makings green showed that the most successful possibility of revitalization is covering with a layer of soil and planting of young trees. In this way the alkalinity of the surface of red mud is decreased and meteoric waters are retained in a great extend. Up till now some 200,000 m² of the disposal site - approximately one half of the total surface - has been successfully planted with trees and grass.

3. WORKING INDUSTRIAL WASTES LANDFILLS

In Slovenia there are 10 industrial wastes landfills and one disposal site for hazardous wastes. All site are shown on Figure 5.

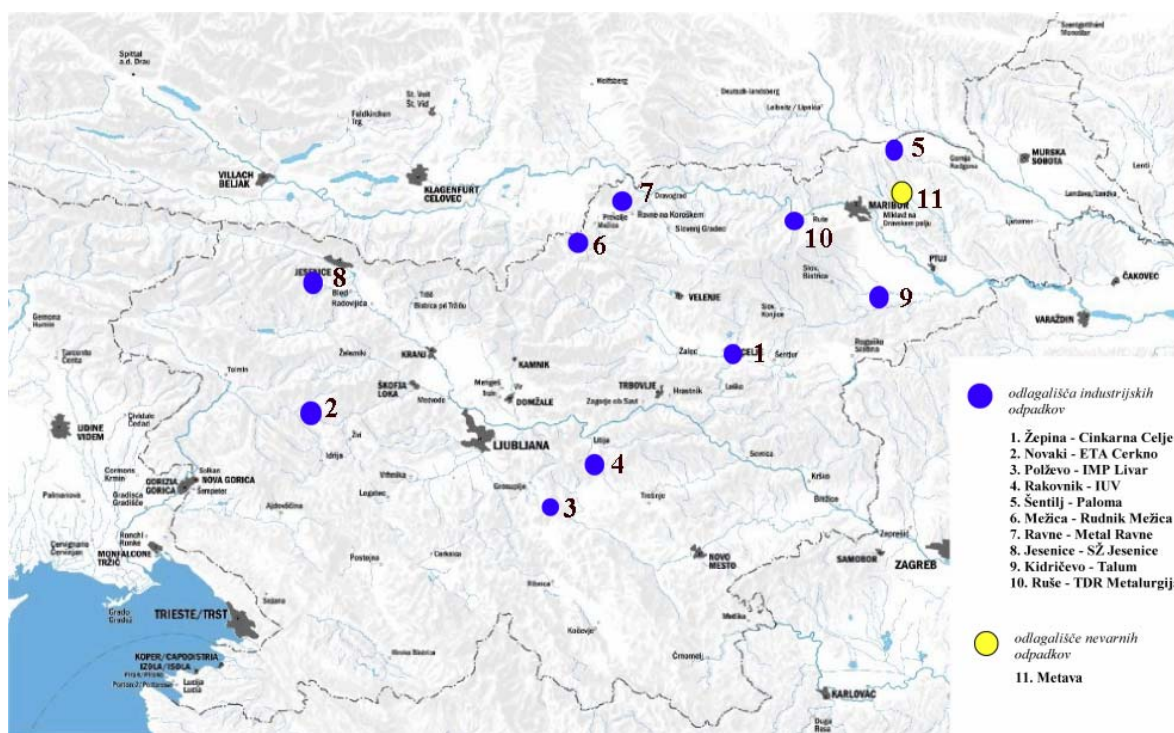

Figure 5. Sites of 10 industrial wastes landfills and one disposal site for hazardous wastes

Table 3. Shows quantities of wastes on individual of mentioned landfill or disposal site

| Activity | Name of the landfill/disposal site | Type of waste | Quantity (t) |
|-----------------------|---|-------------------------------|--------------|
| DG (On Figure 6 – 1) | Landfill of solid wastes in Zepina | Inert and nonhazardous wastes | 220 |
| DJ (On Figure 6 – 2) | Landfill of industrial wastes in Novaki | Inert and nonhazardous wastes | 3087,5 |
| DJ (On Figure 6 – 3) | Disposal site in Polzevo | Inert wastes | 5790 |
| DC (On Figure 6 – 4) | Disposal of leather working industry in Smartno - Rakovnik | Nonhazardous wastes | 4095,2 |
| DE (On Figure 6 – 5) | Landfill of industrial wastes in Paloma | Nonhazardous wastes | 10584 |
| DJ (On Figure 6 – 6) | Landfill of metallurgical slag and crushed plastics in Mežica | Inert and nonhazardous wastes | 1220 |
| DJ (On Figure 6 – 7) | Tailings disposal site of the lead and zinc mine in Ravne | Inert and nonhazardous wastes | 30284 |
| DJ (On Figure 6 – 8) | Tailings disposal site Javornik of the Jesenice ironworks | Inert and nonhazardous wastes | 28950 |
| DJ (On Figure 6 – 9) | Ash disposal site of the aluminum processing plant in Kidricevo | Inert wastes | 1283,1 |
| DJ (On Figure 6 – 10) | Landfill of industrial wastes in Ruše | Inert and nonhazardous wastes | 4475,7 |

Legend of designations for activities:

DG – Manufacture of chemicals, chemical products and man-made fibers

DJ – Manufacture of metals and metal products

DC – Manufacture of leather and leather products

DE – Manufacture of pulp, paper, cardboard, paper and cardboard products, printing

Table 4. Type and quantity of industrial wastes produced in different activities for the year 2000

| Activity | Quantity of all wastes of industry in the year 2000 (tons) | Quantity of wastes in bigger industrial factories in the year 2000 (tons) |
|----------|--|---|
| CA | 141.151 | 11.601 |
| CB | 43.033 | 0 |
| DA | 126.066 | 84.576 |
| DB | 5.141 | 406 |
| DC | 16.195 | 426 |
| DD | 61.226 | 0 |

| Activity | Quantity of all wastes of industry in the year 2000 (tons) | Quantity of wastes in bigger industrial factories in the year 2000 (tons) |
|----------|--|---|
| DE | 144.910 | 115.557 |
| DF | 3.143 | 3.125 |
| DG | 221.571 | 214.448 |
| DH | 12.778 | 3.020 |
| DI | 39.269 | 26.069 |
| DJ | 91.238 | 66.708 |
| DK | 41.755 | 0 |
| DL | 41.491 | 3.370 |
| DM | 31.706 | 0 |
| N | 445.620 | 24.762 |
| Total | 1.466.293 | 554.068 |

Legend of designations for activities:

- CA – Quarrying of energy producing materials
- CB – Mining and quarrying except energy producing materials
- DA – Manufacture of food products, feeding stuffs, verages and tobacco
- DB – Manufacture if textiles and textile and fur products
- DC - Manufacture of leather and leather products
- DD – Manufacture of wood and wood products
- DJ - Manufacture of metals and metal products
- DK – Manufacture of machinery and equipment
- DL – Manufacture of electrical and optical equipment
- DM – Manufacture of transport equipment
- DN – Manufacture of furniture and other processing equipment

In recent years the quantity of waste materials from industry has been decreasing due to the discontinuation of the operation of some mines (the lead and zinc mine in Mežica is in the phase of closing, as is the mercury mine in Idrija); the change of technologies in some industrial branches (ironworks in Jesenice, aluminium processing plant in Kidricevo); and the removal of certain industrial activities to Asia.

In Slovenia there is only one regulated harmful waste disposal site, that is Metava (on the Figure 5, marked with 11). This waste disposal site was built in 1984. Its total capacity is 95,000 m³. For the waste materials deposited on this site there is a list of kinds, quantities and analyses of assay of individual harmful substances. There prevail scoriae from the aluminum factory containing ammonia compounds, casting sands (containing phenols), remaining of dyes and varnishes (containing various organic solvents) and metallic oxides and slimes (containing chrome, nickel, copper and zinc compounds).

Table 5. Shows the quantities of landfilled wastes from 1984 to 2000 on disposal site for harmful and hazardous wastes Metava near Maribor

| Year | Quantity (m ³) |
|------|----------------------------|
| 1984 | 755 |
| 1985 | 2531 |
| 1986 | 1520 |
| 1987 | 1696 |
| 1988 | 957 |
| 1989 | 1525 |
| 1990 | 1327 |
| 1991 | 1034 |
| 1992 | 1065 |
| 1993 | 1047 |
| 1994 | 536 |
| 1995 | 547 |
| 1996 | 530 |
| 1997 | 375 |
| 1998 | 549 |
| 1999 | 588 |

| Year | Quantity (m ³) |
|-------|----------------------------|
| 2000 | 569 |
| TOTAL | 17156 |

4. OMITTED WASTE DISPOSAL SITES

The omitted disposal sites of harmful waste from different industrial branches arose between 1950 and 1990, because of inadequate and uncontrolled disposing of harmful waste from industry. Today they represent an extraordinary danger for the environment. Special technical solutions are required for these old burdens and in some places their remediation has already been running. These disposal sites are:

- the disposal site of acid tar in Pesnica, Studenci and Bohova near Maribor (Figure 6, designation of disposal sites 1, 2, 3),
- disposal site of waste materials arisen in the production of organic acids (tartaric acid, lactic acid, citric acid) in Globocnik near Ilirska Bistrica (Figure 6, designation of the disposal site is 4),
- disposal site of red mud and ashes from the aluminium processing plant in Kidricevo (Figure 6, designation 5)

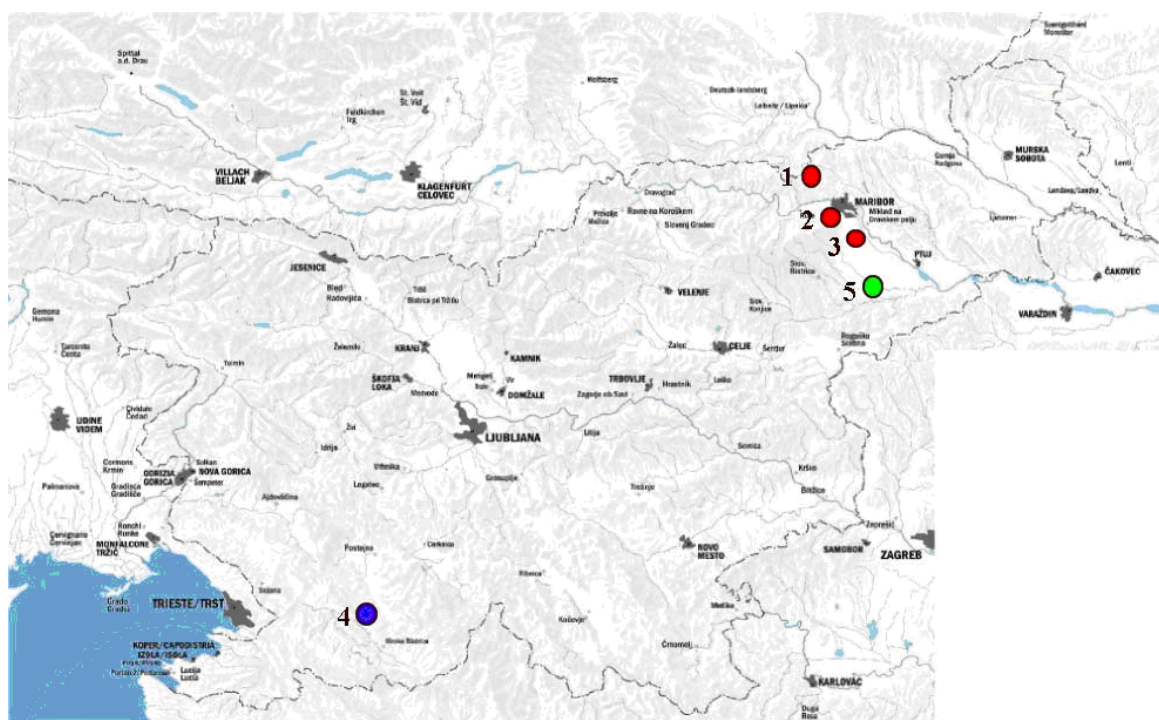

Figure 6. Old burdens disposal sites

Some similar waste disposal sites from the past have already been remedied. However, there still exists a series of so-called »illegal waste disposal sites« that have been discovered by inspection services. In most cases, the persons responsible for these disposal sites are unknown or cannot be found, therefore legislation has been passed that allows for such sites to be remedied from budget funds designated for environmental protection.

4.1 Short Survey and Characteristics of the Mentioned Old Waste Disposal Sites

Ad 4a) On the disposal sites of old acid tar in Pesnica, Studenci and Bohova in years 1955 to 1985, the remainders from the reworking of used motor industrial oils with sulphuric (VI) acid were deposited. The sites were badly selected, namely ground water was leaching in which increased deposited tar levels. The remediation of these disposal sites was started in 1986 and was divided into three steps. As of now, two of these steps have been carried out, namely, works for the protection of disposal sites, the purifying plant for leakages and waste waters was built up – one purifying plant for the three disposal sites. Up till now nearly 5500 m³ of the liquid waste phase has been processed, and some 500 tons of oil and 500 m³ of waste water polluted with tar were removed. It was important that the liquid layers of the waste materials were removed as they risked overflowing into the environment.

Ad 4b) At the end of the 1950s, waste materials arising from the production of organic acids, such as the tartaric, lactic and citric acid, were deposited on the disposal site of communal waste materials in Ilirska Bistrica. In 1965, the disposal site for these waste materials was sited at Globovnik near Ilirska Bistrica. The disposal site operated for 25 years and during this period 120,000 to 150,000 m³ of waste materials were deposited. The status of the omitted disposal site is poor. Although covered with soil and strewing materials, it is exposed to emissions and is washed out with meteoric waters into the near brook. The polluted waters contain increased concentrations of individual elements, such as bromine, calcium, mercury, potassium. Remediation is foreseen in the following decade.

Ad 4c) The omitted disposal site of red mud and ashes in the area of the aluminium processing plant in Kidričevo represents a risk because of the pollution of underground waters. The washing away of individual substances with the meteoric water threatens the underground waters which represent the source of drinking water in that area. The substances that were analysed in the underground waters are characteristic for the substances that remain in the red mud after the production of aluminum from boxite. These substances are: alkaline elements, aluminium, iron, cyanides, fluorides, vanadium and mineral oils. The remediation of this disposal site has been running for some years already, however, it will not be finished before 2015.

5. CONCLUSIONS

In the “Slovene National Program of Environmental Protection”, adopted by the National Assembly of the Republic of Slovenia in 1999 and in the Waste Management Strategy of the Republic of Slovenia, the gradual elimination of old burdens of the environment is foreseen, i.e. remediation of the described contaminated disposal sites. In most of the described locations, it was already started ten or even twenty years ago, and in some of them even earlier.

This remediation has been running relatively satisfactorily above all on the disposal site of the uranium mine at Zirovski vrh and also on other locations where radioactive wastes were deposited.

Also the remediation of disposal sites at heavy metals mines, i.e. in Mezica (Pb, Zn) and Idrija (Hg) has been running for years, albeit slower than expected and as required by the inhabitants in the affected surroundings

The running of the remediation of the waste disposal site of the Jesenice ironworks has been faster than the above mentioned remediations.

The remediation at the waste disposal site of the aluminum processing plant in Kidricevo has been running very poorly or extremely slowly respectively. Also the remediation of the omitted old disposal sites such as:

- disposal site of acid tar in Pesnica, Studenci and Bohova,
- disposal site of waste from the production of organic acids in Ilirska Bistrica, and
- disposal site of red mud in the area of the aluminum processing plant in Kidricevo

has been running very, very slowly and at some locations, it has been previously predicted that it would come to an ecological catastrophe – disposal site of acid tar in Pesnica.

REFERENCES

- Presecnik S., 2003, Diploma thesis, University College of Health Care, University of Ljubljana.
- Sitar S., 1993, Antonijev rov. RZS Idrija. (Antony' s gallery, Idrija Mercury Mine).
- Gosar M., Pirc S. and Bidovec M., 1997, Mercury in the Idrija River sediments as a reflection of mining and smelting activities of the Idrija mercury mine. *Journal of Geochem.*; 58: 125-131.
- Dizdarevic T., 2001, The influence of mercury production in Idrija mine on the environment in the Idrija region and over a broad area. *RMZ Materials*, 48, 1, 56-64.
- Rezun B. and Dizdarevic T., 1999, Zapiralna dela v RZS Idrija s tehnologijo injektiranja. (Closing works in the Idrija Mercury Mine with technology of injecting). *RMZ Materials*, 46, 2, 303-310.
- Miklavcic V., 1996, Idrija kot naravni in antropogeni laboratorij, živo srebro kot glavni onesnaževalec. Srečanje raziskovalcev, Zbornik referatov. (Idrija as a natural and anthropogenous laboratory, mercury as the main polluting agent. Meeting of Investigators, Collection of papers).
- Novelacija dolgoročnega programa popolnega in trajnega zapiranja Rudnika živega srebra Idrija, 1992. (Amendments of the long-term program of complete and durable closing of the Idrija Mercury Mine, 1992).
- Operativni program zmanjševanja onesnaževanja vodnega okolja z emisijami živega srebra iz razpršenih virov onesnaževanja v Republiki Sloveniji, Ministrstvo za okolje in prostor, 2004, (Operative program for the reduction of polluting the water environment with the emissions of mercury from dispersed sources in the Republic of Slovenia, Ministry of Environment and Physical Planning, 2004).
- Druzina B., 2004, Short survey of waste management in Slovenia and possibilities to improve it. European municipal waste partnerships congress. London: Public private finance. P. 1-46.

Chapter 12

MATHEMATICAL MODELING AND EXPERIMENTAL STUDIES ON BIOCHEMICAL CONVERSION OF CR(VI) OF TANNERY EFFLUENT TO CR(III) IN A CHEMOSTAT

K. Samanta, P. Bhattacharya, and R. Chowdhury

Chemical Engineering Department, Jadavpur University, Kolkata-700032, India

Abstract: Biodegradation of hexavalent chromium present in tannery waste has been studied using *Pseudomonas* sp. (JUBTCr1) and *Bacillus* sp. (JUBTCr3) isolated from their native source. A 5L double-jacketed chemostat with 4L working volume has been used as contacting device for the kinetic investigation of the biodegradation process. Varying the feed volumetric rate from 118-133 ml/h for different inlet hexavalent chromium concentrations (30 to 90 mg/dm³), an attempt has been made to study the reaction engineering behavior of the system. It is observed that Haldane-type substrate inhibited model can satisfactorily be used to predict the extent of bioconversion for different dilution rate. Using the kinetic parameters of proposed Haldane equation, a CSTR model was developed. Model prediction agreed well with experimental data.

Key words: Tannery waste; Hexavalent chromium removal; Microbial route; Growth kinetics; Haldane type inhibition, mathematical-modeling.

1. INTRODUCTION

Hexavalent chromium (Cr⁺⁶) is often found in soil and ground water due to its wide spread industrial use in several process industries (Ganguly and Tripathi, 2002, Stern, 1982), such as tannery, electroplating, steel industries etc. Cr⁺⁶ are highly toxic (Zhang et al., 2001, Flores and Perez, 1999), carcinogenic (Lurie and Wolfe, 2002, Losi et al., 1994) and mutagenic (Brien et al., 2001, Stearns et al., 1995) pollutant even at very low concentration (Venitt and Levy, 1974, EPA, 1998, McLean and Beveridge, 2000). As many aerobic and anaerobic microorganisms are capable of reducing Cr⁺⁶ to Cr⁺³, bioremediation may play an important role for the detoxification from Cr⁺⁶ even at very low (ppm or ppb) level.

It has already been reported that due to the presence of some enzymes called chromium reductases (Gu and Cheung, 2001), different microorganisms belonging particularly to the genus, *Pseudomonas* can reduce Cr⁺⁶ to Cr⁺³. The reduction of transformation capacity of Cr⁺⁶ by microorganisms at higher initial concentration of Cr⁺⁶ has been observed by other researchers (Arellano et al., 2004, Middleton et al., 2003) and the phenomenon has been explained by the presence of inhibitory effect of Cr⁺⁶ at high concentration level (Turick et al, 1997). A detailed literature search reveals that although a considerable quantum of investigation has been reported on bioremediation techniques, a meaningful bioprocess study is still awaited.

In the present investigation bacterial strains, namely, *Pseudomonas* sp. and *Bacillus* sp isolated from tannery effluent, have been used for the microbial transformation of hexavalent chromium to trivalent one. Experimental studies have been conducted in batch mode to obtain different intrinsic kinetic parameters of growth of Cr⁺⁶-reducing bacteria. Simultaneously treatment of tannery waste has been done using the same microbial strains in a chemostat with an intension to achieve the high bioconversion. The initial Cr⁺⁶ concentrations in the effluent and the dilution rate have been

considered as process parameters. Starting from differential mass balance, judiciously combined with the Haldane equation, a semi-deterministic mathematical model equation has been developed which is capable of predicting the extent of bioconversion as a function of dilution rate in the chemostat. The simulated equation contains no adjustable parameter and the constants have been computed. The experimental data obtained through a comprehensive and programmed study have been used to verify the proposed equation.

2. MATERIALS AND METHODS

2.1 Materials

2.1.1 Bacterial strains

Microorganisms, namely, *Pseudomonas* sp. and *Bacillus* sp., isolated and purified from polyculture, collected from the liquid effluent of local tanneries, situated in Kolkata, India, has been used for the present investigation.

2.1.2 Chemicals

NH₄Cl (Ranbaxy), MgSO₄, 7H₂O (E. Merck), FeSO₄, 7H₂O (E. Merck), CaCl₂, 2H₂O, (E. Merck), CH₃COONa, 3H₂O (E. Merck), K₂HPO₄ (E. Merck), Yeast extract powder (LOBA chemie), S-diphenylcarbazide (E. Merck), Acetone, AR (E. Merck), H₂SO₄ (E. Merck), MOPS-NaOH buffer (Sigma), K₂Cr₂O₇ (E. Merck) have been used.

2.2 Analytical Instruments

Electronic balance (Afcoset FX-300), B.O.D Incubator-shaker (S.C.Dey & Co., Kolkata), Laminer flow (Bhattacharya & Co., Kolkata), Cold centrifuge (Remi Instrument Pvt. Ltd., Mumbai), Hot air oven (Bhattacharya & Co., Kolkata), Autoclave (G.B. Enterprise, Kolkata), UV shower (Bhattacharya & Co., Kolkata), Furnace (Bhattacharya & Co., Kolkata), Double beam UV-VIS spectrophotometer (Chemito) have been used.

2.3 Methods

2.3.1 Bacterial enrichment

Isolation of monoculture of the individual genus of microorganisms and their subsequent enrichment has been carried out in Lurea broth (acetate-minimal medium) (Pattanapitpaisal, 2001a, 2001b) composed of (per litre) NH₄Cl (1 g), MgSO₄, 7H₂O (0.2 g), FeSO₄, 7H₂O (0.001 g), CaCl₂, 2H₂O (0.001 g), CH₃COONa, 3H₂O (5 g), K₂HPO₄ (0.5 g) and yeast extract powder (0.5 g)). The phosphate source was autoclaved separately in 10 ml distilled water. It was cooled and then added to the rest of the medium. Initially the inoculum of each bacterium (1ml) was inoculated in 20 ml of sterile (0.2 M.Pa., 121⁰C, 15 min) selective media. The growth medium was supplemented with K₂Cr₂O₇ solution at a concentration of 1 mg /dm³ of Cr⁺⁶.

Adaptation of the monoculture consortium to the new microenvironment was carried out for seven days by incubating at 28⁰C in a rotary shaker at 150 rpm. Enriched culture was obtained by repeated inoculation of preceding bacterial culture in fresh selective medium containing K₂Cr₂O₇.

2.3.2 Batch Experiments

To determine the growth kinetics of the microorganisms with respect to different initial Cr⁺⁶ concentration in culture medium, batch experiments (Turick et al, 1997, Bajt et al., 1993) were

conducted in Erlenmeyer flasks with constant shaking. For each run the working hold up volume was maintained at 20 dm³ containing 10 % of inoculum. A constant temperature of 32^oC was maintained. Samples were withdrawn at an interval of 4 hours with a total time span of 48 hours. Two separate batch experiments were conducted with different initial Cr⁺⁶ concentration ranging from 30 mg/dm³ to 90 mg/dm³.

2.3.3 Chemostat

A 5 dm³ double-jacketed Continuous stirred tank reactor (CSTR), fitted with a mechanical agitator was filled with 4 dm³ of sterile tannery effluent. The reactor content was initially inoculated with 0.4 dm³ of inoculum and kept for 10 hours at an ambient temperature of 30^oC to allow the cell growth to reach the exponential phase. A stirrer speed of 200 rpm was maintained. The individual feed solution was then sent continuously to the chemostat through a rotameter. The content was well stirred at 200 rpm and the temperature was maintained at 30^oC. The products were withdrawn continuously. For each initial Cr⁺⁶ concentration, the volumetric flow rate of the feed was varied from 117-137 dm³/hr and steady state was allowed to attain. Liquid effluent of the reactor was analyzed after the attainment of the steady state.

The Cr⁺⁶ concentration in different feed solutions was varied from 70 mg/dm³ to 90 mg/dm³ in the chemostat studied.

2.3.4 Determination of Biomass Concentration

The concentration of bacterial mass in the reaction broth of batch type experiments and the CSTR under steady state was determined both spectrophotometrically and by dry weight method (Shuler, and Kargi, 1992). In this method 20 ml nutrient broth, enriched with bacterial strains, was centrifuged at the rate of 10,000 rpm for 15 minutes and the bacterial mass was washed with buffer solution. The washed wet cell mass was then transferred to a pre-weighed aluminum cup and was dried at 80^oC for 24 hours. The exact weight of the bacterial mass was determined by subtracting the weight of dry cup from that of the cup containing dry bacterial mass. Cell concentration of bacterial suspensions withdrawn at different time intervals was also determined at 600 nm, spectrophotometrically.

2.3.5 Hexavalent Chromium Analysis

The sample under investigation was centrifuged at 10,000 rpm for 15 minutes and the supernatant was collected to measure the residual Cr⁺⁶ concentration. The analysis of Cr⁺⁶ concentration was carried out spectrophotometrically using Cr⁺⁶ specific colorimetric reagent S-diphenylcarbazide (Pattanapitpaisal, 2001a, 2001b). Initially 0.025 g S-diphenylcarbazide was dissolved in 9.67 ml acetone (AR) to prepare S-diphenylcarbazide solution. The test solution was prepared by combining 200 µl sample under investigation, 400 µl 20 mM MOPS-NaOH buffer, 33 µl 3M H₂SO₄, 40 µl S-diphenylcarbazide solution and 327 µl distilled water. The optical density of the above solution was measured at 540 nm using a spectrophotometer.

A standard curve of Cr⁺⁶ concentration against optical density was prepared in the similar way except that in this case 20 µl of known concentration of K₂Cr₂O₇ was used in place of the supernatant. Using this standard curve the residual Cr⁺⁶ concentration of batch experiments or Cr⁺⁶ concentration of chemostat effluent were determined.

3. THEORETICAL ANALYSIS

3.1 Determination of Kinetic Parameters

Determination of intrinsic growth kinetic parameters, viz., substrate saturation constant, maximum specific growth rate and inhibition constant, if any, can conveniently be done from the analysis of

batch performance data. From the results, reported by earlier investigators, it is understood that the bioconversion reaction of Cr^{+6} to Cr^{+3} is inhibited by the substrate when the former is used at a higher concentration level. Since in the present investigation the range of initial concentration is fairly high (70-90 mg/dm³) the reaction rate may logically be assumed to be inhibited by the initial Cr^{+6} concentration. Under such situation the most classical semi deterministic model equation proposed by Haldane is still an important tool for prediction of cell growth rate. The classical substrate inhibited Haldane equation for cell growth rate is given by

$$\mu = \frac{\mu_{\max} C_A}{K_S + C_A + \frac{C_A^2}{K_i}} \quad (1)$$

The above equation contains three kinetic parameters, viz., μ_{\max} , K_S , K_i . More over, the concentration of substrate at which the maximum growth of microorganisms occurs ($C_{A_{\max}}$) is also an important parameter for growth kinetic study. Shuler and Kargi (Shuler and Kargi, 1992) have given an expression for obtaining the magnitude of $C_{A_{\max}}$ from the known value of kinetic parameters as follows

$$C_A = \sqrt{K_S K_i} = C_{A_{\max}} \quad (2)$$

Eq. (1) clearly shows that the specific growth rate is strongly dependent upon the initial substrate concentration and a plot of μ vs C_A can be used to identify the substrate uninhibited regime and substrate inhibited regime. The point of inflexion of the curve will indicate the substrate concentration for maximum growth rate ($C_{A_{\max}}$). The data lying in the region of substrate uninhibited section can be used to determine μ_{\max} and K_S from the double reciprocal plots of $1/\mu$ against $1/C_A$. On the other hand experimental data lying in the substrate inhibited region can be used to determine the substrate inhibition constant K_i from the plot $1/\mu$ against C_A . In the present investigation the above exercise has been meticulously done and the magnitude of each kinetic parameter has been determined. These are shown in Table 1.

3.2 Model Equation for Chemostat

The mathematical model equation for predicting the substrate concentration in the reactor effluent has been carried out using following assumptions:

1. Microorganisms follow the same intrinsic growth kinetics.
2. The density of reaction mixture is reasonably constant.
3. Ideal mixing condition exists in the Chemostat.

The schematic of the flow pattern in the chemostat used in the present investigation for the transformation of Cr^{+6} to Cr^{+3} is shown in Fig. 1.

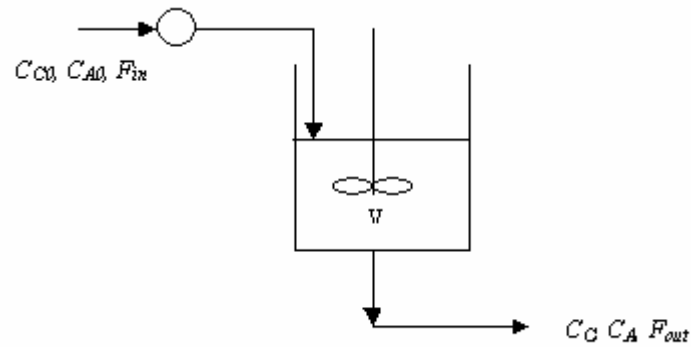

Figure 1. Schematic representation of chemostat

The material balance equation for substrate in chemostat of constant reaction volume under dynamic condition may be written as:

$$V \frac{dC_A}{dt} = F_{in} C_{A_0} - F_{out} C_A - \frac{1}{Y_{C/A}} \mu C_C V \quad (3)$$

Under the steady state condition when the Eq. (3) becomes:

$$D C_{A_0} - D C_A - \frac{1}{Y_{C/A}} \mu C_C = 0 \quad (4)$$

$$\text{where } D = \frac{F}{V} \text{ and } F_{in} = F_{out} = F \quad (5)$$

Similarly the differential mass balance equation for biomass under dynamic state is given by:

$$\frac{dC_C}{dt} = -D C_C + \mu C_C \quad (6)$$

Under steady state condition $\frac{dC_C}{dt} = 0$, giving an important relation between the specific growth rate and the dilution rate as follows:

$$D = \mu \quad (7)$$

Comparing Eq. (1) and Eq. (7) one gets:

$$D = \frac{\mu_{max} C_A}{K_S + C_A + \frac{C_A^2}{K_i}} \quad (8)$$

A simple calculation on Eq. (8) gives a simulated equation for C_A as follows:

$$C_A = \frac{-(DK_i - K_i\mu_{\max}) - \sqrt{(DK_i - K_i\mu_{\max})^2 - 4D^2K_iK_S}}{2D} \quad (9)$$

Thus knowing the kinetic parameters and form a preset value of dilution rate one can predict the chromium concentration in the reactor effluent and consequently one can calculate the extent of conversion as well.

4. RESULTS AND DISCUSSION

The cell growth time history curves and Cr^{+6} depletion as a function of initial Cr^{+6} concentration, derived from batch mode reaction, are shown in Fig.2 and Fig.3 for *Pseudomonas* sp. and *Bacillus* sp. respectively. The simulated values of the above variables for both the above mentioned monocultures have been computed using Haldane equation and have been plotted on the same figure. The figures clearly indicate the presence of an insignificant lag period followed by the usual exponential phase. Lag phase is not very clear probably due to prior adaptation of the microbes during purification stage. Analysis of substrate depletion curves reveals that at higher Cr^{+6} concentration, the trend of the exponential decay is not followed. This nature is an indication of substrate inhibition of cell growth at higher initial Cr^{+6} concentration as observed also by other investigators.

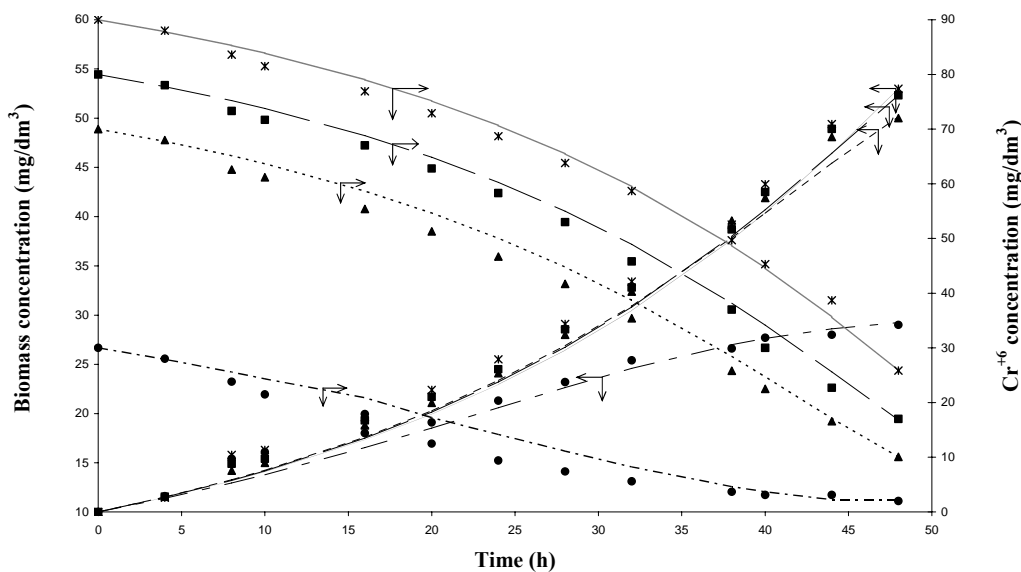

Figure 2. Time history of hexavalent chromium and biomass (*Pseudomonas* sp.) concentration with initial Cr^{+6} concentration as a parameter. (* 90mg/dm³ Experimental; ■ 80mg/dm³ Experimental; ▲ 70mg/dm³ Experimental; ● 30mg/dm³ Experimental; _____90mg/dm³ Simulated; - - - - 80mg/dm³ Simulated; - · - · - 70mg/dm³ Simulated; · · · · · 30mg/dm³ Simulated)

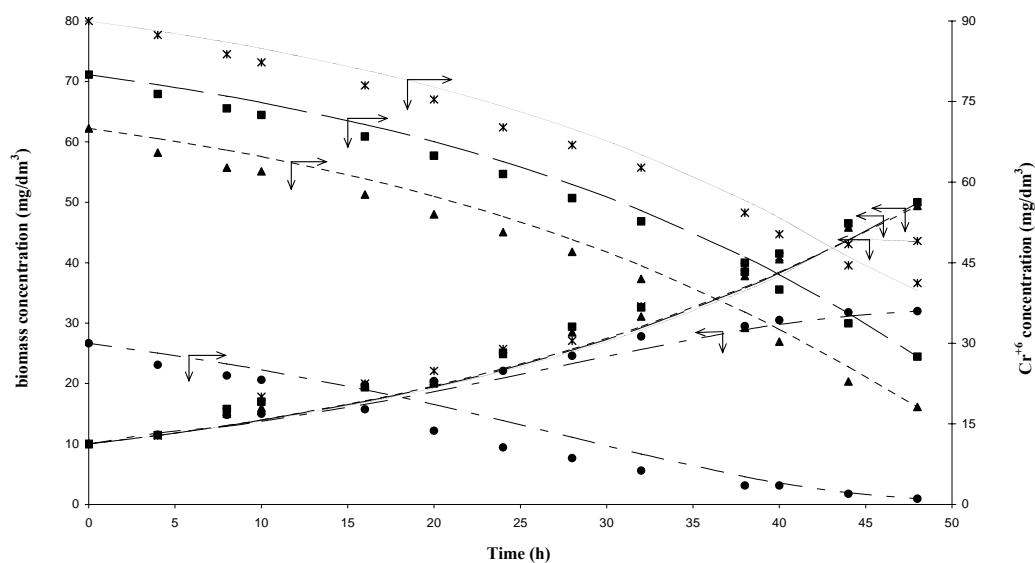

Figure 3. Time history of hexavalent chromium and biomass (*Bacillus* sp.) concentration with initial Cr^{+6} concentration as a parameter. (* 90mg/dm^3 Experimental; ■ 80mg/dm^3 Experimental; ▲ 70mg/dm^3 Experimental; ● 30mg/dm^3 Experimental; — 90mg/dm^3 Simulated; - - - 80mg/dm^3 Simulated; - - - - 70mg/dm^3 Simulated; - - - - - 30mg/dm^3 Simulated)

The initial specific cell growth rate (μ) has been computed and plotted against the corresponding initial Cr^{+6} concentration, which is shown in Fig.4. Both the figures shown in Fig.4 show that μ increases up to a particular Cr^{+6} concentration, beyond which the value of μ declines with increasing initial Cr^{+6} concentration. This is the clear indication of the presence of substrate inhibition. In such case, Haldane substrate inhibited model equation has been proposed and different kinetic parameters have been determined following the technique, discussed under theoretical analysis section.

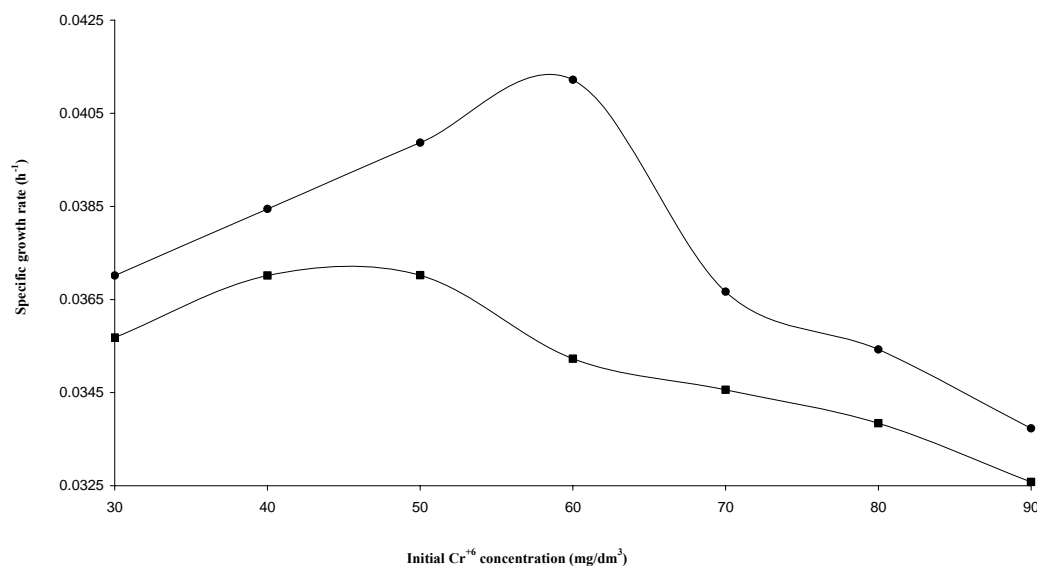

Figure 4. Dependence of specific growth rate of *Pseudomonas* sp and *Bacillus* sp. on hexavalent chromium. (● *Pseudomonas* sp.; ■ *Bacillus* sp)

Experiment on chemostat as the contacting device for the bioconversion of Cr^{+6} to Cr^{+3} has been conducted under steady state condition by varying initial Cr^{+6} concentration from 70 – 90 mg/dm^3 and

by setting a fixed dilution rate by adjusting suitable volumetric flow rate. For each fixed dilution rate and for a particular inlet substrate concentration the reactor effluent has been analysed for its Cr^{+6} concentration. The percentage conversions computed from the knowledge of initial substrate concentration have been plotted against the corresponding dilution rate for both the monoculture, *Pseudomonas* sp. and *Bacillus* sp. using Cr^{+6} concentration as parameter. These are shown in Fig.5 and Fig.6.

As expected the conversion of Cr^{+6} increases with the decreasing dilution rate due to longer residence time of the reactant inside the reactor. The simulated value of Cr^{+6} concentration has been calculated using Eq.(9) and the same has been plotted on Fig. 5 and Fig. 6 for comparison. It is observed that the experimental data fit reasonably well with the simulated values. It may therefore be concluded that the proposed model equation from computation of C_A and C_C as given in Eq.(9) and Eq.(4) respectively can conveniently be used for predicting the substrate conversion and the corresponding biomass concentration. From the analysis of Fig.5 and Fig. 6 it is observed that the maximum Cr^{+6} reduction takes place at dilution rate 0.029 h^{-1} for *Pseudomonas* sp. (77.21%) and *Bacillus* sp. (79.22 %).

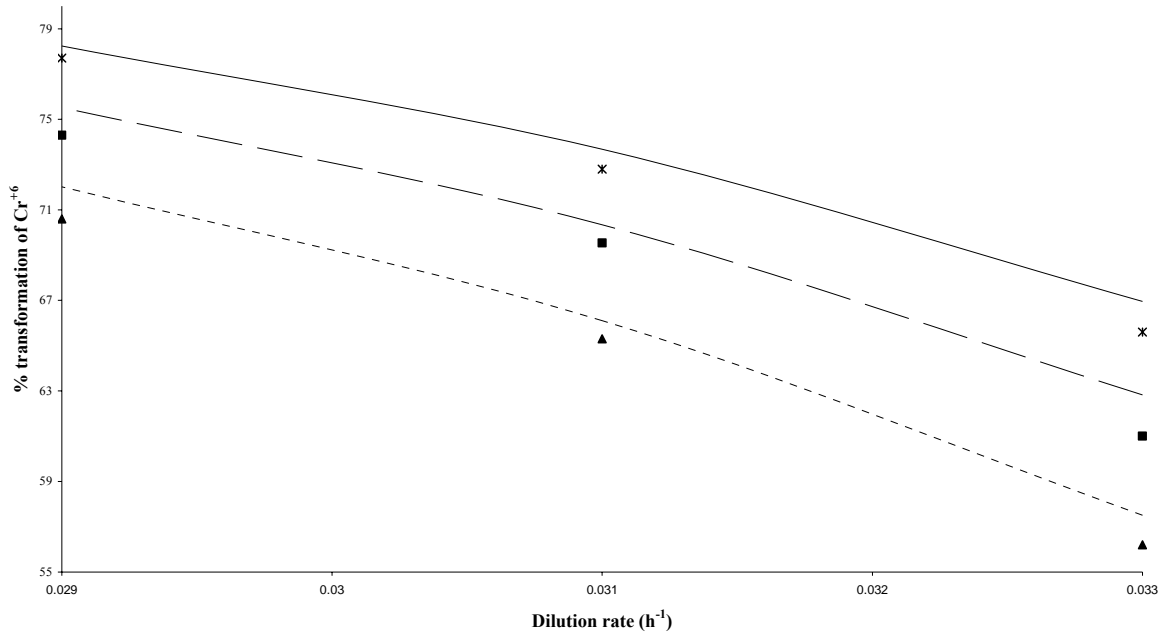

Figure 5. Dependence of percentage transformation of Cr^{+6} on dilution using *Pseudomonas* sp. (* 90 mg/dm^3 Experimental; ■ 80 mg/dm^3 Experimental; ▲ 70 mg/dm^3 Experimental; _____ 90 mg/dm^3 Simulated; - - - - 80 mg/dm^3 Simulated; - . - . - 70 mg/dm^3 Simulated)

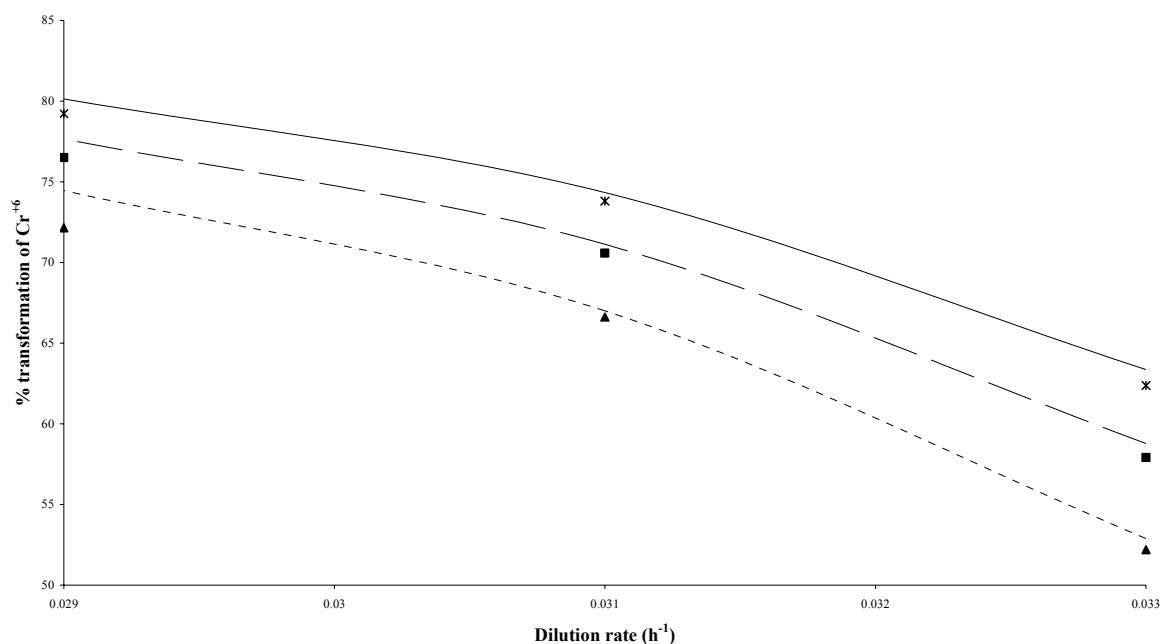

Figure 6. Dependence of percentage transformation of Cr⁺⁶ on dilution using *Bacillus* sp. (* 90mg/dm³ Experimental; ■ 80mg/dm³ Experimental; ▲ 70mg/dm³ Experimental; _____ 90mg/dm³ Simulated; - - - - 80mg/dm³ Simulated; - · - · - 70mg/dm³ Simulated)

5. CONCLUSION

Studies on bioconversion of Cr⁺⁶ to Cr⁺³ have been conducted using *Pseudomonas* sp. and *Bacillus* sp. separately. Initially the microorganisms have been isolated from the local tannery effluent and later have been purified and identified regarding their genera. Growth kinetics of each of the above microorganisms has been studied using a batch fermentor and the information obtained from this experiment has been utilized to determine the kinetic parameters using Haldane type substrate inhibited model equation. The process engineering study has been extended to a chemostat with an intention to predict the reactor performance. In the present investigation, a judicious simulation work has been carried out to develop semi-deterministic model equation for predicting Cr⁺⁶ concentration in the reactor content as well as the corresponding biomass concentration. Comparison of experimental data with the simulated values indicates the validity of the simulated equation.

Table 1. Growth kinetic parameters of two different bacterial cultures

| Microbial strain | Mmax (hr-1) | KS (mg/dm3) | Ki (mg/dm3) | Camax (mg/dm3) | YC/S |
|------------------------|-------------|-------------|-------------|----------------|-------|
| <i>Pseudomonas</i> sp. | 0.046 | 16.32 | 200.37 | 57.18 | 0.665 |
| <i>Bacillus</i> sp. | 0.056 | 9.43 | 305.29 | 53.66 | 0.776 |

ACKNOWLEDGEMENTS

Authors gratefully acknowledge the financial support received from the Department of Science and Technology, Govt. of India to carry out this research work.

NOMENCLATURE

Cr⁺³ Trivalent chromium

| | |
|------------------|---|
| Cr^{+6} | Hexavalent chromium |
| C_C | Biomass concentration, mg/dm^3 |
| C_A | Substrate concentration, mg/dm^3 |
| $C_{A_{\max}}$ | Substrate concentration at which the maximum growth of microorganisms occurs mg/dm^3 |
| $Y_{C/A}$ | Yield coefficient of cell mass with respect to substrate concentration = Mass of cells produced / mass of substrate consumed |
| K_S | Monod constant, mg/dm^3 |
| K_i | Inhibition constant |
| V | Working volume of Reactor, dm^3 |
| F | Flow rate, ml/h |
| F_{in} | Inlet flow rate, ml/h |
| F_{out} | Outlet flow rate, ml/h |
| D | Dilution rate |
| μ | Specific cell growth rate, h^{-1} |
| μ_{\max} | Maximum specific cell growth rate, h^{-1} |

REFERENCES

- Arellano, H.G., Alcalde, M. and Ballesteros, A. 2004. Use and improvement of microbial redox enzyme for environmental purposes. *Microbial Cell Factories*. 3(10), doi: 10.1186/1475-2859-3-10.
- Bajt, S., Clark, S.B., Sutton, S.R., Rivers, M.L. and Smith, J.V. 1993. Synchrotron x-ray microprobe determination of chromate content using x-ray absorption near-edge structure. *Anal. Chem.* 65, 800-1804.
- EPA (Environmental Protection Agency). 1998. Toxicological Review of Hexavalent Chromium. US Environmental Protection Agency, Washington DC.
- Flores, A., Perez, J.M. 1999. Cytotoxicity, apoptosis, and in vitro DNA damaged induced by potassium chromate. *Toxicol Appl Pharmacol.* 161, 75-81.
- Ganguly, A., Tripathi, A.K. 2002. Bioremediation of toxic chromium from electroplating effluent by chromate-reducing *Pseudomonas aeruginosa* A2Chr in two bioreactors. *Appl Microbiol Biotechnol* 58, 416-420.
- Gu, J.D. and Cheung, K.H. 2001. Phenotypic expression of *Vogesella indigofera* upon exposure to hexavalent chromium, Cr^{6+} . *World Journal of Microbiology and Biotechnology*. 17, 475-480.
- Losi, M.E., Amrhein, C. and Frankenberger, W.T. 1994. Environmental biochemistry of chromium. *Rev Environ Contam Toxicol.* 136, 91-121.
- Lurie, P. and Wolfe, M.S. 2002. Continuing exposure to hexavalent chromium, a known lung carcinogen: An analysis of OSHA compliance inspections. *American journal of Industrial Medicine.* 5, 378-383.
- McLean, J. and Beveridge, T.J. 2000. Chromate reduction by a Pseudomonad isolated from a site contaminated with chromate copper arsenate. *Applied and Environmental Microbiology.* 2, 611-619.
- Middleton, S.S., Latmani, R.B., Mackey, M.R., Ellisman, M.H., Tebo, B.M. and Criddle, C.S. 2003. Cometabolism of Cr(VI) by *Shewanella oneidensis* MR-1 Produces Cell-Associated Reduced Chromium and Inhibits Growth. Wiley InterScience(www.interscience.wiley.com) doi: 10.1002/bit.10725.
- O'Brien, Xu, J. and Patierno, S.R. 2001. Effect of glutathionine on chromium-induced DNA crosslinking and DNA polymerase arrest. *Molecular and Cellular Biochemistry.* 222, 173-182.
- Pattanapitpaisal, P., Brown, N.L. and Macaskie, L.E. 2001. Chromate reduction and 16S rRNA identification of bacteria isolated from a Cr(VI) -contaminated site. *Appl Microbiol Biotechnol.* 57, 257-261.
- Pattanapitpaisal, P., Brown, N.L. and Macaskie, L.E. 2001. Chromate reduction by *Microbacterium liquefaciens* immobilized in polyvinyl alcohol. *Biotechnology Letters* 23, 61-65.
- Shuler, M.L. and Kargi, F. 1992. How cells grow. In: *Bioprocess Engineering Basic Concepts*, pp 169-170, 151. (Acricos, A., Dahler, J., Hanratty, T.J., Prausnitz, J.M. and Scriven, L.E. Eds.). Prentice-Hall, Inc., New Jersey Press.
- Stern, R.M. 1982. Chromium compounds: production and occupational exposure. In: *Biological and Environmental Aspects of Chromium*, pp. 547. (Langard, S., Ed.). Amsterdam: Elsevier Press.
- Stearns, D.M., Kennedy, L.J., Courtney, K.D., Giangrande, P.H., Phieffer, L.S. and Wetterhahn, K.E. 1995. Reduction of chromium (VI) by ascorbate leads to chromium-DNA binding and DNA strand breaks in vitro. *Biochemistry.* 34, 910-919.
- Turick, C. E. and Apel, W.A. 1997. A bioprocess strategy that allows for the selection of Cr(VI) -reducing bacteria from soils. *Journal of industrial Microbiology & Biotechnology.* 18, 247-250.
- Venitt, S. and Levy, L.S. 1974. Mutagenicity of chromates in bacteria and its relevance to chromate carcinogenesis. *Nature.* 250, 493-495.

Zhang, Z., Leonard, S.S., Wang, S., Vallyathan, V., Castranova, V., and Shi, X. 2001. Cr(VI) induces cell growth arrest through hydrogen peroxide. *Molecular and Cellular Biochemistry* 1(2), 77-83.

Chapter 13

SORPTION OF ANTIMONY IN STREAM WATER BY WEATHERED AND ALTERED ROCK

Sakae Sano¹, Masayuki Sakakibara², Etsuko Chiba² and Rie Hori²

¹Earth Science Laboratory, Faculty of Education, Ehime University, Matsuyama, 790-8577 Japan; ²Graduate School of Sciences and Engineering, Ehime University, Matsuyama, 790-8577 Japan

Abstract: The ionic migration of antimony in various weathered and country rocks during chemical weathering was studied. The Ichinokawa abandoned mine of Shikoku Island, Japan is famous for the production of stibnite. The antimony deposits are mainly in Sambagawa metamorphic rocks and the brecciated rocks (Ichinokawa breccia) formed through a hydro-fracturing process associated with hydrothermal fluid related to Tertiary igneous activity around the area. Antimony content in stream water around the mine was extremely high (over 200 $\mu\text{g/L}$), which indicates that antimony dissolves into the water from the country rocks by chemical weathering. We examined the antimony contents in variously weathered and altered country rocks in the streambed, to understand the transfer of the element into the stream water. Consequently, antimony content in brown-colored, strongly weathered and altered part of the rocks was higher than that in the unweathered (or weakly weathered) part. The antimony content in the strongly weathered part was several tens to hundreds ppm, although the content in unweathered part was significantly low, sometimes under the detection of XRF. This may indicate that the antimony in the stream water is adsorbed selectively in the strongly weathered and altered part of the streambed rock. The strongly weathered and altered rocks contain many iron hydroxides, which may trap antimony ion from the water. A similar phenomenon was observed in the other area. This suggests that a high distribution of antimony ion into the strongly weathered and altered rocks including iron hydroxides against the water is ubiquitous.

Key words: antimony, stibnite, Ichinokawa, Tobe, hydrothermal alteration, chemical weathering, iron hydroxide.

1. INTRODUCTION

Chemical behavior and toxicity of antimony is similar in principle to that of arsenic (Gurnani et al., 1994; WHO, 1996; Filella et al., 2002). Because of the toxicity, antimony and its compounds are considered as priority pollutants by the European Union (Council of the European Communities, 1976) and the Environmental Protection Agency of the United States (USEPA, 1979). More detailed examinations are needed to understand the chemical behavior of antimony, since the toxicity depends on the various environmental conditions. The upper limit of the concentration of antimony in drinking water is defined as 5 $\mu\text{g/L}$ by WHO (1996) and CEU (1998), and 6 $\mu\text{g/L}$ by USEPA (1999). Stream waters around the studied area, Ichinokawa and Tobe stibnite mine areas, Shikoku, Japan, include $>200 \mu\text{g/L-Sb}$ by solvated out of antimony from the country rocks by chemical weathering (Sano et al., 2005, 2006; Ohno et al., 2006). There is a great possibility that the water originating from the stream at the downstream of the densely populated area and arable land will be contaminated. Therefore, the effect of the pollution is a major concern for the human health in the area.

Although chemical behavior at common surface water environment of arsenic belongs to the same group as antimony of metalloid elements and is therefore relatively well studied (Bowell, 1994; Smedley and Kinniburgh, 2002), the detailed behavior of antimony is still not well known (Filella et al., 2002). Based on our study, antimony contents in stream waters in a finite area vary from one locality to another (Sano et al., 2006). This is expected because of the chemical interactions between

the water and rocks or sediments of the streambed. In this paper, we reported the phenomena of selective sorption of antimony by the rocks of the streambed during chemical weathering at oxidized surface conditions. Moreover, we showed that chemical weathering is a function of natural purification of antimony in the stream water.

2. MATERIALS AND METHODS

2.1 Geologic background

Study areas of Shikoku Island in southwestern Japan are shown in Figure 1. Large amounts of Tertiary volcanic rocks are distributed along the Median Tectonic Line (MTL), which divide southwestern Japan into inner and outer zones. Hydrothermal activity related to the Tertiary volcanism developed some ore deposits at Ichinokawa and Tobe mines along the southern part of the MTL.

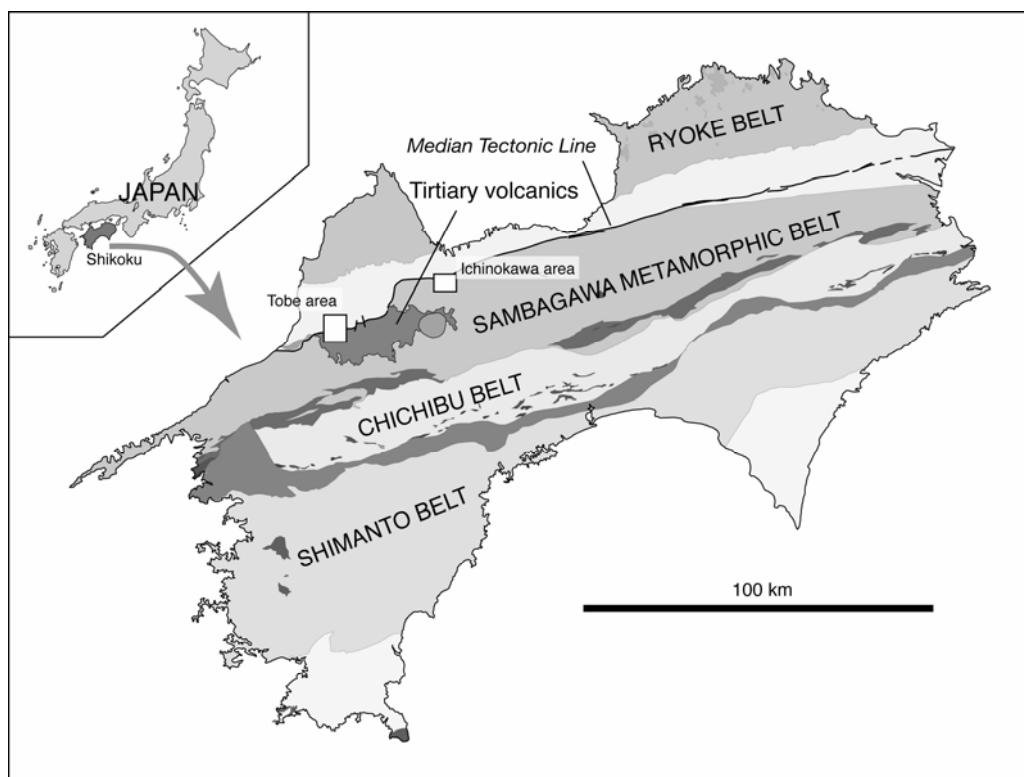

Figure 1. Geologic outline of Shikoku Island, Japan. Studied areas are shown as open squares with “Ichinokawa area” and “Tobe area”. Both areas locate to just southern border of Median Tectonic Line. Tertiary volcanics are widely distributed around the studied areas.

2.1.1 Ichinokawa area (Figure 1)

Ichinokawa mine is a famous stibnite yielding mine in Japan. The host rocks of the ore deposit are Mesozoic Sambagawa metamorphic rock and Ichinokawa conglomerate. Rocks around the ore deposit suffer severe hydrothermal alteration. The conglomerate, country rock of the stibnite deposit, can be divided mainly into fracture-filling breccia in the Sambagawa pelitic schist and carbonaceous sandstone with andesite pebbles. The brecciated rocks are formed by a hydraulic fracturing process of

the Tertiary hydrothermal influx into the fault zone related to MTL movement in the Sambagawa metamorphic rocks (Sakakibara et al., 2005a). Stibnite precipitates from the hydrothermal fluid.

2.1.2 Tobe area (Figure 1)

Many small mines of sulfide minerals such as pyrite, chalcopyrite, arsenopyrite and stibnite were developed in the Tobe area located in the southern part of the MTL. The ore deposits of the Tobe area were developed in the Tertiary andesite body and surrounding Mesozoic Sambagawa metamorphic rocks. The country rocks of the deposits also suffer severe Tertiary hydrothermal alteration (Chiba et al., 2005; Sakakibara et al., 2005b), which is also the case in the Ichinokawa area.

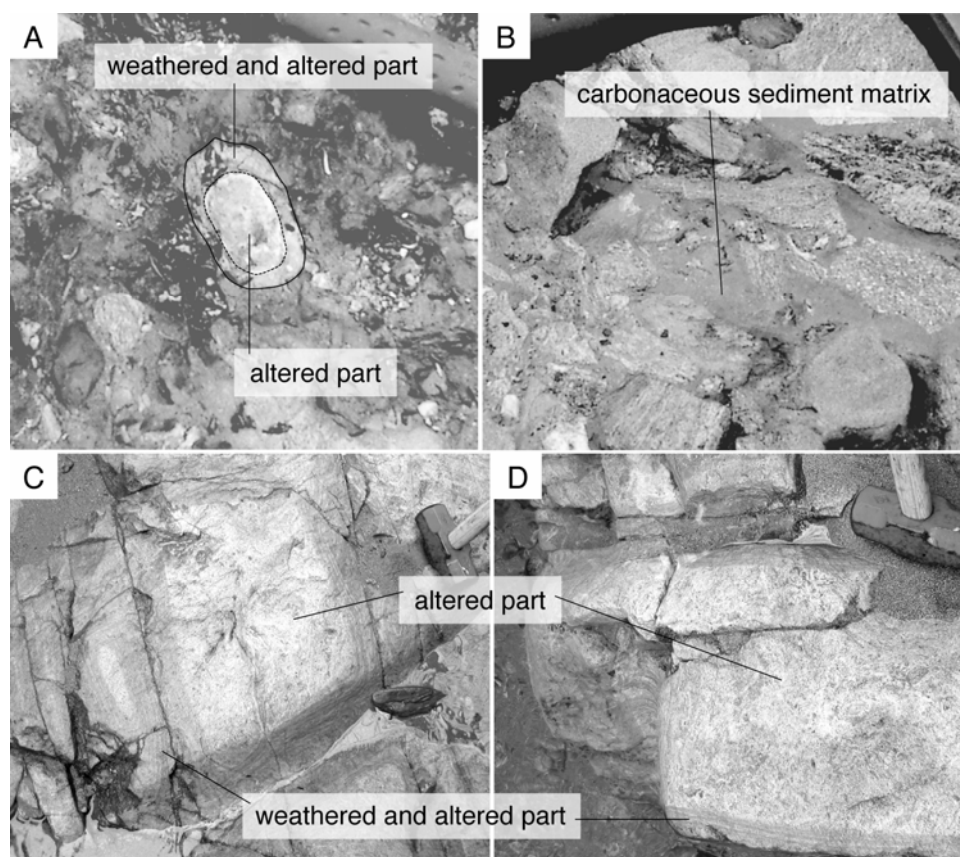

Figure 2. Photos of rock surface condition in fields. A & B: Ichinokawa area, and C & D: Tobe area. A: hydrothermally-altered andesite pebble in carbonaceous sediment matrix. Thick weathered crust surrounds unweathered part. B: carbonaceous sediment matrix. C & D: streambed of altered andesite. The hydrothermally-altered rocks are rimmed by brown colored weathered parts.

Hydrothermally altered rocks, including sulfide minerals, undergo chemical weathering due to the oxidation conditions at the surface. Consequently, it has been shown that stream waters around the Ichinokawa and Tobe areas contain high concentrations of arsenic and antimony liquated from the rocks of the streambeds (Sano et al., 2005, 2006; Ohno et al., 2006). High contents of antimony ($>200 \mu\text{g/L-Sb}$) were detected from the waters downstream of the adit portals of the both mines. At the Tobe area, stream water contained locally $>700 \mu\text{g/L-Sb}$. The pH values of the stream water from both areas were about 7 and did not show extreme features of acid mine drainage (AMD).

2.2 Rock Description

The color of hydrothermally altered andesites without significant weathering is whitish. They include sulfides as secondary minerals. The primary minerals of the altered andesites are completely replaced by secondary products. Based on the pseudomorphs of primary minerals at weakly altered parts and the secondary mineral assemblages, we estimate primary minerals to include the following: plagioclase, orthopyroxene, opaque mineral, and apatite. Identified secondary minerals are quartz, opal, carbonates (calcite/dolomite), chlorite, titanite, anatase, illite, kaolinite, pyrite, marcasite, arsenopyrite, stibnite, chalcopyrite, and/or iron hydroxide. Although sulfides can be visible by eye at the unweathered (or weakly weathered) part, it is difficult to recognize the sulfides at the weathered part because they are replaced by iron hydroxides. The weathered part displays brownish color due to the formation of abundant iron hydroxides. Quartz, kaolinite, chlorite, anatase, and illite are also formed in the weathered part.

Carbonaceous sandy sediments including the andesite pebbles are mainly composed of quartz and white mica fragments originating from pelitic schists, and interstitial carbonates such as rhodochrosite, siderite, and calcite/dolomite.

2.3 Samples and analytical methods

We collected rock samples of pairs of weathered and unweathered parts of andesite pebbles and the carbonaceous matrix of streambeds from the Ichinokawa area (Figure 2A and B). As shown in Figure 2A, hydrothermally altered andesite pebble has an unweathered and whitish core with a weathered and brownish crust. Unweathered and surrounding weathered parts of the altered andesites of the streambed, which intrudes into Sambagawa pelitic schist, were collected from the Tobe area (Figure 2C and D). We also acquired drilled core samples from the hydrothermally altered andesite body. The depth was 15–23 m from ground level. We distinguished each level rock as weathered and unweathered. We determined major and trace element abundances for rocks of streambeds from the lower reaches of the Ichinokawa and Tobe mining areas, utilizing the XRF of Ehime University. Detailed analytical procedures and accuracy results are described in Yoshizaki et al. (1996) and Hori and Higuchi (1996).

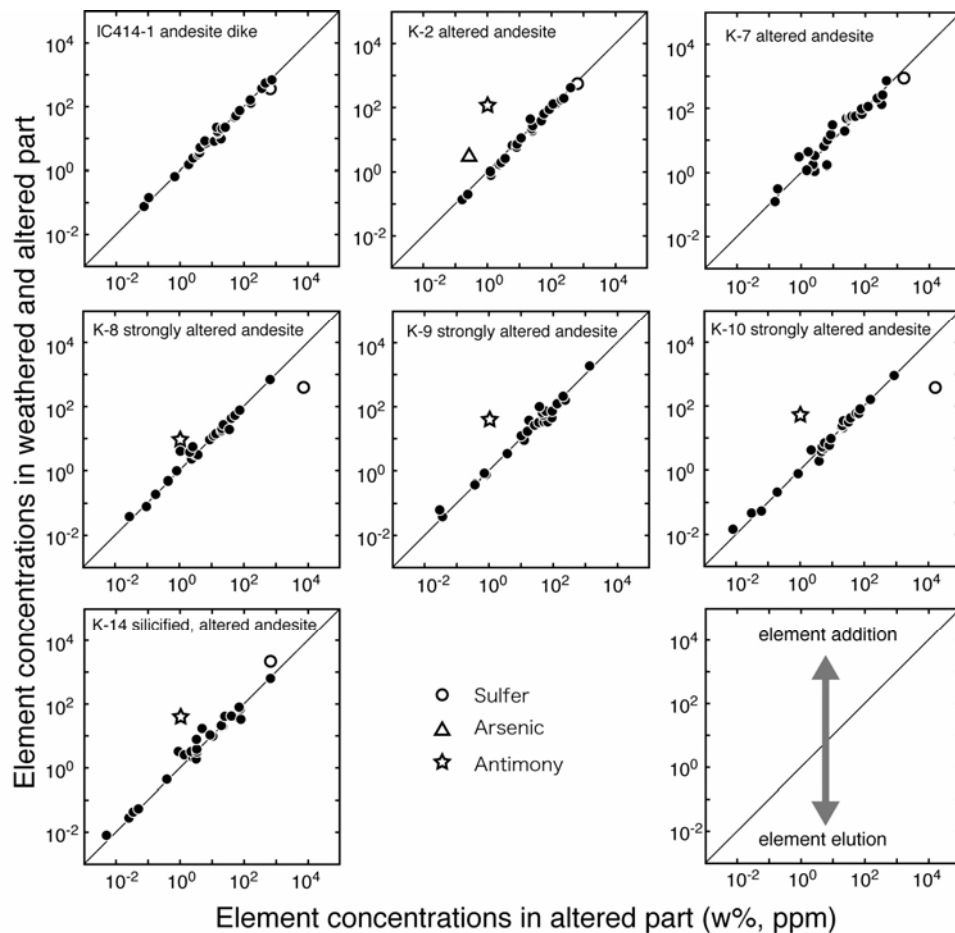

Figure 3. Plot of major and trace elements abundance of pairs of weathered/alternated and unweathered/alternated andesite pebbles from the Ichinokawa streambed.

3. RESULTS

Relatively high antimony content was detected on weathered rocks as compared with unweathered parts. On the Ichinokawa altered andesite pebble, although antimony contents of most unweathered core parts were under the lower limit of detection (LLD: ca. 1 ppm Sb), the contents of weathered crust part were 9.2–119 ppm. Weathered parts of carbonaceous sandy sediment matrix of the altered andesite pebble contained antimony of 32–54 ppm, while the antimony of the weakly weathered part was under the detection. Furthermore, on the Tobe altered andesite, although antimony contents of unweathered parts were from LLD to 13 ppm, the contents of weathered parts were 3–27 ppm. The antimony contents of weathered parts of drilled samples from the altered andesite body were 13–190 ppm, while the unweathered parts contained antimony of 3–33 ppm. It has been reported that the average antimony content in the upper continental crust was 0.2 ppm (Taylor and McLennan, 1995). If we compare the antimony content of the upper continental crust to that of a common andesite, antimony of the weathered and altered andesites in this study enriches to ca. 1000 times of common andesite.

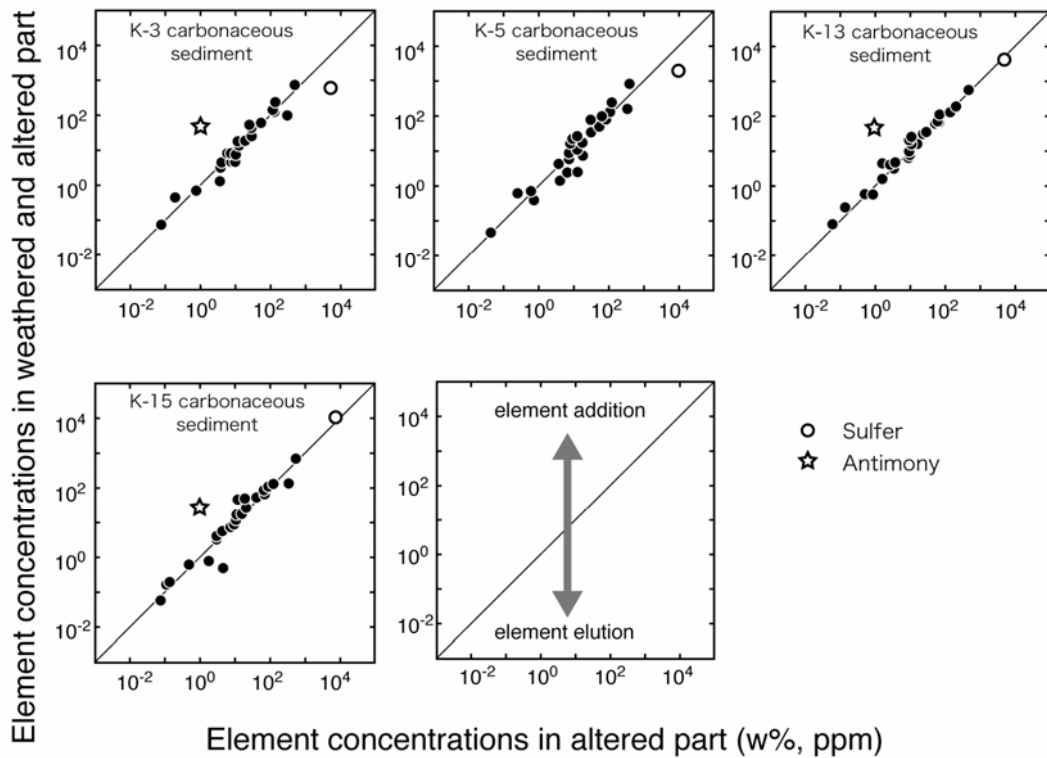

Figure 4. Plot of major and trace elements abundance of pairs of weathered/alternated and unweathered/alternated parts of carbonaceous sediment from Ichinokawa streambed. These rocks form matrix of the andesite pebbles (Figures 2A & B).

To examine the element behavior during chemical weathering, analytical results of paired data sets of weathered and unweathered parts are plotted in Figures 3–5. The horizontal axis represents contents of major (wt%) and trace elements (ppm) for unweathered but altered rock, and the vertical axis represents those for weathered and altered rock. That is, the plot on the 1:1 line means that the element does not show significant removal during chemical weathering. On the contrary, plot above the 1:1 line indicates an increase of the content, and the plot below the line indicates a decrease of the content during weathering. Plots in Figure 3 display the results of samples from the streambed of Ichinokawa altered andesite pebbles in the carbonaceous sediment matrix. On the five pairs, increase of antimony and decrease of sulfur are apparent. Figure 4 shows the results of carbonaceous sandy sediments. Three of four samples indicate the increase of antimony. On the other hand, relative increases of antimony are also observed in the altered andesite from the Tobe area (Figure 5), although result of the Tobe area was not as clear compared with that of the Ichinokawa area. In the same figure, results of altered andesite from the drilled core are consistent with other results. Altered andesite samples of 15–23 m from the ground display increase of antimony and decrease of sulfur during chemical weathering. Consequently, it is clear that the increase of antimony and decrease of sulfur are ubiquitous phenomena during chemical weathering.

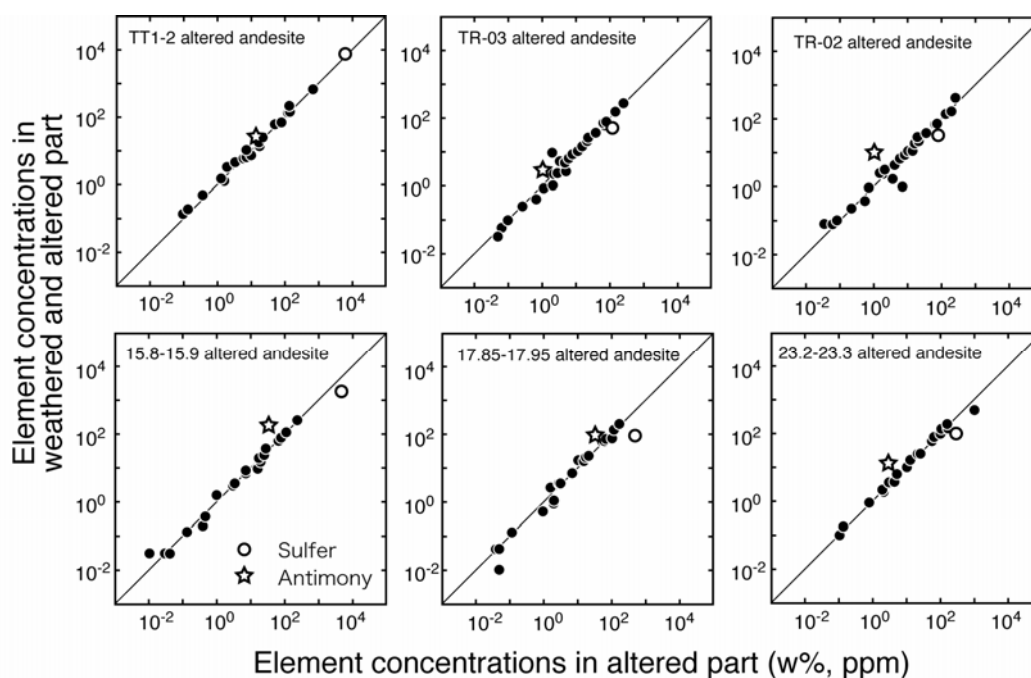

Figure 5. Plot of major and trace elements abundance of pairs of weathered/alternated and unweathered/alternated andesites of streambed from the Tobe area.

4. DISCUSSION

4.1 Mobilization of antimony during weathering

Sorption of metals dissolved in water by iron oxyhydroxides is well documented. Metalloids such as arsenic and antimony especially are adsorbed effectively by iron oxyhydroxides (Thanabalasingam and Pickering, 1990; Bowell, 1994). The weathered crust of the altered andesites and the pebbles from the Ichinokawa and Tobe areas exhibit brownish color by formation of a large amount of iron hydroxides. It is expected the selective sorption of metalloids dissolved in water to weathered part of the rocks. The relationship of elemental distribution between the brownish weathered part and the whitish unweathered part, do not show apparent migration during the weathering, except for sulfur, arsenic, and antimony (Figure 3–5). Migration of arsenic is not very obvious. Because antimony contents of unweathered and altered andesites often could not be detected by the XRF, we plotted the contents as 1 ppm instead of the LLD (ca. 1 ppm) on these figures (Figure 3–5). Andesites, in this study, suffered severe hydrothermal alteration. Rock color changed to a whitish color and many sulfide minerals were formed. Therefore, sulfur contents of the rocks as a whole are higher than that of usual andesite. Though arsenic and antimony contents of sulfide concentrated parts were high, the contents of other normal parts were almost the same level with common andesites. Many rock samples from the unweathered part had low antimony contents under the LLD. However, antimony contents of weathered and altered parts were significantly higher than the LLD level. To consider the mobilization of elements during the chemical weathering, we estimated the mobilization factors (MF). The factor is defined as follows:

$$\text{MF for element } i = (C_{i,w} - C_{i,uw}) / (C_{i,uw}) * 100$$

where, $C_{i,w}$ and $C_{i,uw}$ represent concentrations of element i in the weathered part and unweathered part, respectively. Results of element mobilization during chemical weathering are shown in Figure 6. Each diagram represents averaged value on every rock types, Ichinokawa altered andesite pebbles (conglomerate), Ichinokawa carbonaceous sediments (matrix of the conglomerate), and Tobe altered

andesites (body). Based on the diagram, it is clear that the increasing elements are iron, manganese, arsenic, and antimony, and the decreasing elements are magnesium, calcium, and sulfur. Especially, the mobilization factor of antimony was exceptionally large at approximately 260–5300 times of unweathered rocks compared with that of other elements. Arsenic and antimony belong to a same metalloid group. However, the chemical behavior during weathering of antimony must be different from that of arsenic.

Tighe et al. (2005) reported sorption of Sb(V) effectively by amorphous iron (III) hydroxide and humic acid in organic matter rich soils. Mueller et al. (2006) considered the major and trace element abundances in stream waters and the sediments on the streambeds around gold mine areas of Alaska and Yukon districts. They showed the possibility that the chemical behavior between arsenic and antimony is different under certain conditions, because the oxidation state of antimony adsorbed on sediment is Sb(V), while that of arsenic exists as mixture of As(III) and As(V), at the surface environmental condition. Under the condition of existence of amorphous iron oxyhydroxide, Sb(III) is oxidized to Sb(V), and adsorbed on the oxyhydroxide (Belzile et al., 2001). Furthermore, it has been reported that antimony in stream water is adsorbed selectively on the co-existing amorphous iron hydroxides under the pH of around 7 (Sano et al., 2006).

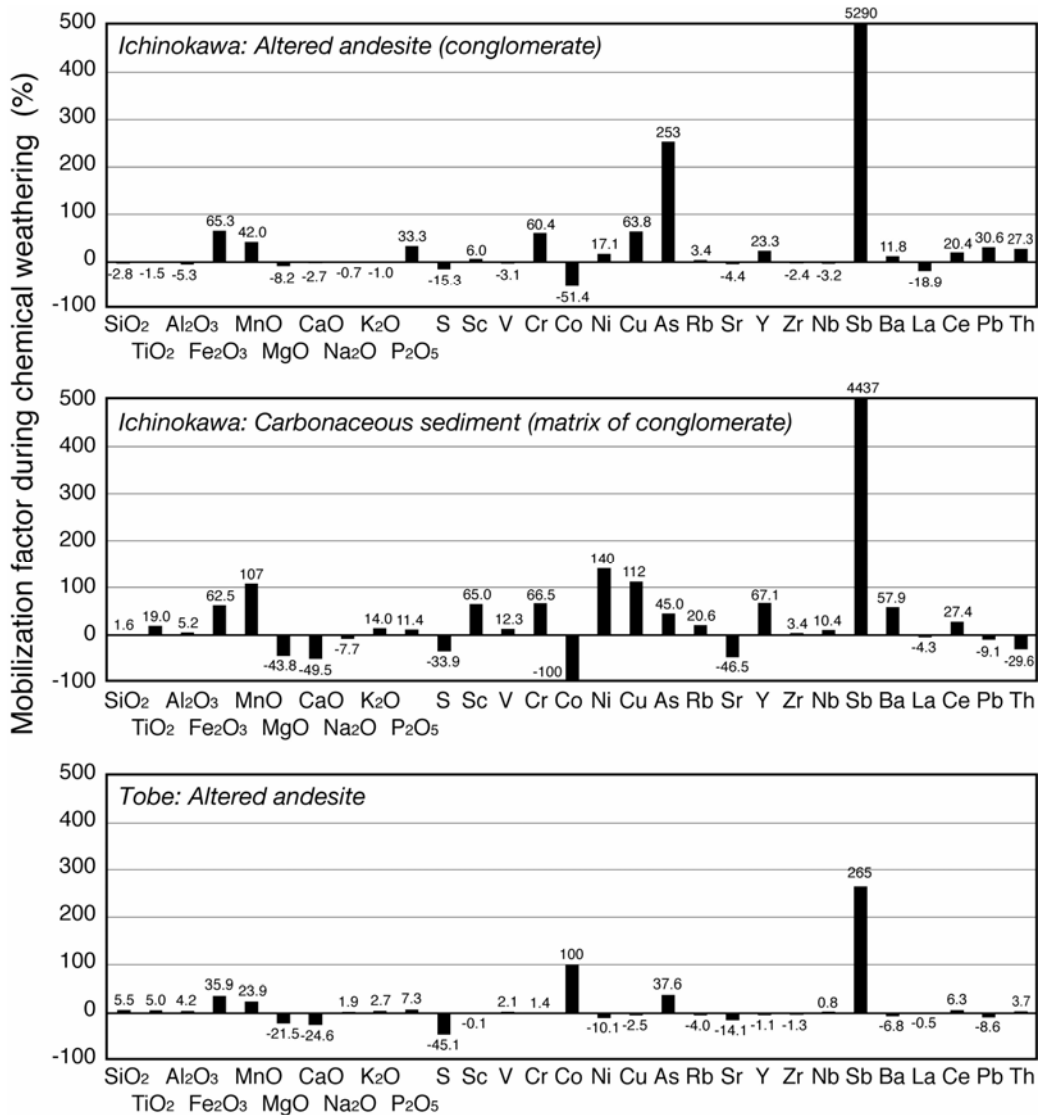

Figure 6. Mobilization factors for major and trace elements in streambed rocks. The factor means the mobilization of elements during the chemical weathering. That is, bars showing positive side mean high mobility into weathered parts as compared with relatively unweathered parts of the rocks. Each bar graphs represent averaged value on rock type, Ichinokawa

altered andesite pebbles (conglomerate), Ichinokawa carbonaceous sediments (matrix of the conglomerate), and Tobe altered andesites, respectively. Note the special positive mobilization of antimony to weathered part.

Sano et al. (2006) observed some precipitation of amorphous iron hydroxides at the stream downward of the Ichinokawa stibnite mine area. At the lower reaches of appearance of the hydroxides, the antimony contents in the water decreased drastically from >200 µg/L at the upper reaches to 3.6 µg/L with the appearance of the amorphous iron hydroxides. They showed that the amorphous iron hydroxides have high distribution for antimony. Iron hydroxides are common in oxidized, natural earth's surface environment. The weathered rock surface consisting of abundant iron hydroxides of streambeds might be a natural and efficient purification system for antimony dissolved in stream water.

5. CONCLUSION

In this study, we mainly reported sorption of antimony in stream water by weathered and altered rocks composing the streambed. Element mobilization during chemical weathering was considered by results of the major and trace element abundances in hydrothermally altered/weathered or unweathered andesites and carbonaceous sediments. Iron, manganese, arsenic, and antimony distribute to the weathered part of the rocks, but magnesium, calcium, and sulfur are removed to the stream water. The mobilization factor of antimony is exceptionally high as compared with other element such as arsenic. Antimony distributes strongly into amorphous iron hydroxides under the common stream water environment. Because the abundant iron hydroxides are often formed in weathered rocks, the chemical weathering process contributes naturally to purification of antimony from the stream water.

ACKNOWLEDGEMENTS

We thank the Grant for Research and Development Assistance of Ehime University for their support.

REFERENCES

- Belzile, N., Chen, Y.-W. and Wang, Z. 2001. Oxidation of antimony (III) by amorphous iron and manganese oxyhydroxides. *Chem. Geol.* 174, 379-387.
- Bowell, R.J. 1994. Sorption of arsenic by iron oxides and oxyhydroxides in soils. *Appl. Geochem.* 9, 279-286.
- CEC (Council of the European Communities). 1976. Council Directive 76/464/EEC of 4 May 1976 on pollution caused by certain dangerous substances discharged into the aquatic environment of the Community. *Official Journal L* 129, 18/05/1976, 23-29.
- CEU (Council of the European Union). 1998. Council Directive 98/83/EC of 3 November 1998 on the quality of water intended for human consumption. *Official Journal L* 330, 05/12/1998, 32-54.
- Chiba, E., Sakakibara, M., Sano, S., Hori, R., and Nakai, Y. 2005. Behavior of major and trace elements of the Mannen altered andesite during chemical weathering in the Tobe Town, Ehime Prefecture, Japan. *Mem. Fac. Sci. Ehime Univ.* 11, 39-46. (in Japanese with English abstract)
- Filella, M., Belzile, N., and Chen, Y.-W. 2002. Antimony in the environment: a review focused on natural waters I. Occurrence. *Earth Sci. Rev.* 57, 125-176.
- Gurnani, N., Sharma, A., and Tulukder, G. 1994. Effects of antimony on cellular systems in animals: a review. *Nucleus* 37, 71-96.
- Hori, R.S., and Higuchi, Y. 1996. Quantitative analysis of trace elements in rock samples by X-ray fluorescence spectrometry, using Rh anode tube. *Mem. Fac. Sci., Ehime Univ.* 2, 27-36. (in Japanese with English abstract)
- Mueller, S., Trainor, T., Ritchie, V., and Newville, M. 2006. Antimony mobility and speciation associated with the oxidation of stibnite-bearing waste rock from the eastern Tintina gold province, Alaska and Yukon. 102nd Annual Meeting of the Cordilleran Section, GSA, 81st Annual Meeting of the Pacific Section, AAPG, and the Western Regional Meeting of the Alaska Section, SPE, Paper No. 18-9.

- Ohno, H., Sano, S., and Sakakibara, M. 2006. Trace element abundance in river water of the Tobe River system, Tobe Town, Ehime Prefecture, Japan. *Mem. Fac. Sci. Ehime Univ.* 12, 11-18. (in Japanese with English abstract)
- Sakakibara, M., Hiraoka, Y., Hori, R., Kimura, K., and Nakajima, K. 2005a. Behavior of arsenic and antimony in Ichinokawa breccia formed by Miocene hydrothermal activities, Saijo City, Ehime Prefecture, Japan. *Mem. Fac. Sci. Ehime Univ.* 11, 65-80. (in Japanese with English abstract)
- Sakakibara, M., Chiba, E., Chikaishi, S., and Nakai, Y. 2005b. Geology and hydrothermal alteration of Mannen altered andesite in the Tobe Town, Ehime Prefecture, Japan. *Mem. Fac. Sci. Ehime Univ.* 11, 19-26. (in Japanese with English abstract)
- Sano, S., Okada, T., Sakakibara, M., and Chiba, E. 2005. Trace element abundance in river water around the Mannen altered andesite body, Tobe-town, Ehime Prefecture, Japan. *Mem. Fac. Sci. Ehime Univ.* 11, 47-57. (in Japanese with English abstract)
- Sano, S., Sakakibara, M., and Chiba, E. 2006. Arsenic and antimony abundances in river water and the environmental mobility by iron hydroxide: Case study of Ichinokawa mine area. *Jour. Geo-pollution Sci., Medical Geol, Urban Geol.* (submitted) (in Japanese with English abstract)
- Smedley, P.L. and Kinniburgh, D.G. 2002. A review of the source, behaviour and distribution of arsenic in natural waters. *Applied Geochem.* 17, 517-568.
- Taylor, S.R. and McLennan, S.M. 1995. The geochemical evolution of the continental crust. *Reviews in Geophysics* 33, 241-265.
- Thanabalasingam, P., and Pickering, W.F. 1990. Specific sorption of antimony (III) by the hydrous oxides of Mn, Fe, and Al. *Water, Air, Soil Pollut.* 49, 175-185.
- Tighe M, Lockwood P, Wilson S. 2005. Adsorption of antimony(V) by floodplain soils, amorphous iron(III) hydroxide and humic acid. *J Environ Monit.* 1177-1185.
- USEPA (United States Environmental Protection Agency). 1979. *Water Related Fate of the 129 Priority Pollutants*, vol. 1. USEPA, Washington, DC, USA, EP-440/4-79-029A.
- USEPA (United States Environmental Protection Agency). 1999. *National Primary Drinking Water Standards*. USEPA Office of Water, Washington, DC, USA, Doc. 810-F-94-001.
- WHO (World Health Organization). 1996. *Guidelines for Drinking-Water Quality: Volume 2. Health Criteria and Other Supporting Information* (2nd ed.). World Health Organisation, Geneva. 973.
- Yoshizaki, T., Tamura, Y., Sano, S., Hori, R., and Komatsu, M. 1996. X-ray fluorescence analysis of major elements for silicate rocks. *Mem. Fac. Sci., Ehime Univ.* 2, 15-25. (in Japanese with English abstract)

PART VI: Miscellaneous

Chapter 14

SOYBEAN DERIVED FUEL LIQUIDS AS ADDITIVES FOR MIDDLE DISTILLATE TRANSPORTATION FUELS

George W. Mushrush, Douglas G. Mose and Joy W. Bauserman
Chemistry Department, George Mason University, 4400 University Drive, Fairfax, VA 22030; Corresponding Author: George Mushrush, Phone (703) 993-1080, Fax (703) 993-1055, E-mail gmushrus@gmu.edu

Abstract: Biodiesel liquids are increasingly being used as blending stocks with middle distillate ground transportation fuels or as a fuel itself. However, an upper limit of 20% biodiesel is common for a soy derived biodiesel blending stock with petroleum diesel fuels. It is important for operational consideration to look at the many problems this could present. Among the more important considerations are storage stability, filterability, temperature ranges, fuel compatibility, oxidative stability, and induced instability reactions. We compare the soy methyl esters to the untreated soy cooking oil for compatibility with petroleum fuels.

Key words: Biodiesel, Soybean fuels, Middle distillate, Methyl esters, Instability

1. INTRODUCTION

It is environmentally enticing to consider replacing or blending petroleum derived middle distillate fuels with biofuels for many reasons. Major considerations include the soaring world-wide price of petroleum products, especially diesel fuel and home heating oil, the toxicity of the petroleum-derived fuels and the environmental damage that leaking petroleum tanks can cause. For these reasons, it has been suggested that domestic agricultural renewable energy sources be considered as replacements, or at the least, as blending stocks for middle distillate fuels. If recycled soy restaurant cooking oils could be employed for this purpose, this would represent a further environmental advantage. Renewable plant sources of energy tend to be less toxic than their petroleum counterparts. This is an important consideration when tank leakage occurs. In proposing such a replacement, considerations must be given to the many problems that could arise. Problems to be studied include fuel storage stability, fuel solubility, oxidative stability, and seawater stability.

Truck fleet operators are one of the largest consumers of middle distillate fuels and this has ramifications throughout the fuel market especially in the winter months when home heating oil competes with diesel for limited refinery capacity. Many schemes have been proposed to decrease the nation's dependence on imported foreign crude oil. Most non-renewable sources, such as used automobile and truck tires or consumer plastic residues, produce products that require a great amount of additional processing to be useful. Renewable sources including plants, i.e., corn, soybeans or other vegetable oils, provide a viable resource as long as they can be produced and refined in suitable

quantities. Of these plant derived materials, soybeans provide the most oil, up to 20% by weight, and the oil produced is cheaper than that of any other plant source, 17-20 cents/pound.

Diesel fuel specifications are very restrictive as to the quality of the product and the additives permitted. It is thus with great care that additives are considered. Important considerations in the use of additives include fuel solubility in the fuel at ambient and low temperatures, flash point, effect on cetane number and storage stability (ASTM, 1997). A critical point, however, is that the blending stock should not induce chemical instability in the fuel itself (Mushrush and Speight, 1998).

In the present research, we report on two different soybean derived blending stocks. Both were added in 10% and 20% blends with a known stable and then a known unstable petroleum middle distillate fuel. The blending stocks were obtained from different manufacturers and were commercially available. We examined the storage stability and the instability reactions. We looked at the fuel stability of these blends under both ambient and accelerated storage conditions.

2. EXPERIMENTAL

2.1 General Methods

Unless otherwise stated, chemicals were reagent grade and were obtained from commercial sources and used without additional purification.

2.2 Storage Stability Tests

The soy-fuel blends, 10% and 20%, were tested for storage stability and chemical instability reactions. They were tested by a gravimetric technique described in ASTM D5304-99a. A brief description of this method is: 100 mL sample of the blends in 125 mL borosilicate brown glass bottles were subjected to a 16 hour, 90°C time-temperature regimen at 100 psig overpressure of pure oxygen. After the reaction period, the samples were cooled to room temperature. The samples were filtered and the sediment determined by a gravimetric procedure.

2.3 Ambient Oxidative Stability Tests

The biodiesel liquids were subjected to a steady stream of ambient air for a one-week time period. The reaction was carried out in a one liter flask connected to an aspirator protected by a safety bottle. The air was filtered through a drying tube filled with anhydrous CaSO₄ with fiberglass plugs before passing through the soy derived liquid.

2.4 Soy Derived Biodiesel Fuel

Ag Environmental Products, 9804 Pflumm Road, Lenexa, KS 66215, supplied soy-derived biodiesel (SoyGold®) fuel A. This material was light yellow in color, had a boiling point greater than 400°F, negligible water solubility, a specific gravity of 0.88, a flashpoint of 425°F and a cetane number > 40. An eastern U.S. company distributed soy-derived biodiesel fuel B. It had a boiling point greater than 400°F, negligible water solubility, a specific gravity of 0.86, and a flashpoint greater than 300°F. No information on its cetane number was supplied. Both soy fuels, as supplied, had been converted to the methyl ester. No acidic material remained. This was confirmed by gc/ms as shown in Table 1.

2.5 Middle Distillate Fuels

All storage stability testing was done by ASTM D-5304. The petroleum middle distillate fuels were from our extensive inventory of well-characterized fuels. The stable fuel (No. 2 diesel) was an

American refined fuel that has been used as a stable fuel for comparison in our laboratory. This fuel yielded 0.2-mg of solids/100 mL fuel, and was therefore characterized as a very stable fuel. The unstable fuel was a Spanish refined number 2-diesel fuel. This fuel has historically been an unstable fuel, forming 2.5 mg of solids/100 mL fuel. This yield of solids ranks this fuel as very unstable.

3. RESULTS AND DISCUSSION

Petroleum derived diesel fuel has an average carbon number range of about C₁₃ up to about C₂₁ and a distillation range of about 150-400°C (300-750°F). To be acceptable by the military, a diesel fuel must meet many other specifications (ASTM, 1999b; MIL Spec., 1995). These include, for example, API gravity, flash point, pour point, water solubility, cetane number, acid number, total sulfur, filterability, and color test (ASTM, 1999b, 1999c). The soy-derived fuel meets many of these specifications such as flash point, API gravity, boiling point, cetane number and water solubility. These values were listed in the Experimental Section. The identity and concentration of the soy-derived methyl esters were confirmed by gc/ms analysis as shown in Table 1. No evidence of organosulfur or organonitrogen or other hetero-atomic compounds was detected. It was observed that only soy fuel (A) would pass the ASTM Color Test (ASTM, 1999b). Soy fuel (B) was a darker colored yellow liquid. It has been observed that this darkening may be related to degradation.

Table 1. Concentration in weight percent of the soy methyl esters in the biodiesel sample

| Soy Methyl Ester | Carbon Number | Concentration in wt% |
|-------------------|-----------------|----------------------|
| methyl linoleate | C ₁₈ | 53 |
| methyl oleate | C ₁₈ | 24 |
| methyl stearate | C ₁₈ | 10 |
| methyl palmitate | C ₁₆ | 10 |
| methyl linolenate | C ₁₈ | 3 |

Table 2 illustrates the storage stability results for the soy-derived blending stocks. The storage stability ASTM-D5304 procedure yields results that are indicative of a one to two-year storage life for the fuel. Any fuel or fuel blend that gives gravimetric results of more than 2 mg of sediment/100 mL of fuel represents an unstable fuel. Table 2, depicts the results for diesel ground transportation fuels containing 10% and 20% blends of the methylated biodiesel soy liquids that were investigated. The results show that the soy fuel, SoyGold[®] (A), contained an antioxidant, which enhanced the stability for both the stable and unstable diesel fuels. For the 10% blends, 0.3 mg of solids/100 mL fuel formed and for the 20% blends, 0.2 mg of solids/100 mL fuel formed with the stable fuel. However, this was not the case for the second soy blending stock, (B), which contained no antioxidant. This soy liquid proved unstable for both the 10% and 20% blends. Results for the 10% blends yielded 3.0 mg of solids for the 10% soy blends and 4.6 mg of solids for the 20% soy blends.

The unstable petroleum derived diesel consistently has failed ASTM D-5304 storage test procedure with 2.5 mg of solids/100 mL of fuel. When this unstable fuel was blended with 20% soy liquid (A), a very dramatic change was noted.

Table 2. Storage stability of petroleum derived fuel and soy-petroleum and cooking oil-petroleum blends

| Fuels | Gravimetric Sediment/100mL Fuel | |
|----------------------------------|---------------------------------|-------------|
| | Methyl Esters | Cooking Oil |
| Stable petroleum diesel | 0.6 | 0.6 |
| Unstable petroleum diesel | 2.5 | 2.5 |
| Fuel blends | | |
| 10% soy A – 90% stable diesel | 0.3 | 2.7 |
| 20% soy A – 80% stable diesel | 0.2 | --- |
| 20% soy A – 80% unstable diesel | 0.5 | --- |
| 10% soy B – 90% stable diesel | 3.0 | 4.4 |
| 20% soy B – 80% stable diesel | 4.6 | --- |
| 10% soy B – 90 % unstable diesel | 3.0 | --- |

This unstable fuel easily passed the storage stability test with only 0.5-mg of solids/100mL of fuel. This was the first time that we observed such a drastic change. Our laboratory has not noted this type of change with any other biofuel (corn, peanut, canola, etc.) blending stock. However, these observations were not duplicated in the case of soy-derived fuel liquid (B). When this biodiesel fuel liquid was blended with both petroleum derived fuels, the results were not very good. The stable petroleum diesel, both 10% and 20% soy (B) blends, failed the ASTM D-5304 Storage Stability test procedure. Both of these blends would thus lead to filter and injector plugging and other serious mechanical engine problems. The situation was even worse for the unstable petroleum fuel. The 10% soy (B) blend with the unstable petroleum diesel gave 3.0 mg of solids/ 100 mL and thus, unlike soy liquid (A) observations, the fuel remains unstable.

The presence of an antioxidant also had another effect on the two biofuel liquids studied in this work. It was observed that soy fuel (A) did not darken with exposure to light and air while soy fuel (B) darkened significantly. Several literature reports note that a color change may or may not be indicative of fuel oxidation reactions (Mushrush and Speight, 1995; Hiatt, 1971).

The same ASTM stability procedure was followed for another series of runs employing new soybean restaurant cooking oil. The results in Table 2 clearly show that this oil should not be used by large fuels users that buy fuels in bulk and store the fuel for any significant length of time. The 20% soy runs were not measured since the 10% soy oil did not pass the ASTM D-5304 stability procedure. Individual consumers that use a petroleum fuel cooking oil mixture immediately upon blending should not have any significant mechanical or operational problems.

4. CONCLUSION

Two soy bean derived blending stocks were obtained from two different manufactures. Both claimed to meet military specifications. Soy fuel A and Soy fuel B both appeared similar by GC and ¹H NMR. Soy blending stock A passed with ease all of the chemical tests while soy blending stock B failed all of the same procedures. Since both biodiesels had similar chemical and physical properties the differences in both storage stability and oxidative behavior may be attributed to the presence of antioxidants or to the presence of an ineffective antioxidant. New or filtered used soy derived cooking oils are satisfactory for individual consumers, but not large fleet operators that buy fuels in bulk and store them for any significantly length of time.

REFERENCES

- ASTM, American Society for Testing Materials. 1997. Standard Specification for Fuel Oils, Annual Book of ASTM Standards;ASTM:Philadelphia, Part 05.01 ASTM D975-96, pp. 165-168.
- ASTM, American Society for Testing Materials. 1999a. Standard Test Method for Assessing Distillate Fuel Storage Stability by Oxygen Overpressure, Annual Book of ASTM Standards; ASTM: Philadelphia, Part 05.03, ASTM D5304-99, pp. 569-572.
- ASTM, American Society for Testing Materials. 1999b. Standard Test Method for Determining Color of Petroleum Products, Annual Book of ASTM Standards; ASTM: Philadelphia, Part 05.01, ASTM D1500-98, pp. 547-551.
- ASTM, American Society for Testing Materials. 1999c. Standard Test Method for Determining Filterability of Distillate Fuel Oils, Annual Book of ASTM Standards; ASTM:Philadelphia, Part 05.03, ASTM D5304-99, pp. 6426-99.
- Hazlett, R. N., J. M. Hall in *The chemistry of engine combustion products*. L. B. Ebert (ed), New York: Plenum Press, p. 245.
- Hiatt, R. R. 1971. in *Organic peroxides*, Volume II. New York:Wiley Interscience, Chpt 1.
- MIL Spec., 1995. Military Specification MIL-T-83133D.
- Mushrush, G. W., J. G. Speight. Reviews in Process Chemistry & Engineering, 1998, 1(1) 5-29.
- Mushrush, G. W., J. G. Speight, 1995 in *Petroleum Products*. Taylor and Francis: Philadelphia, PA.

PART VII: Perchlorate

Chapter 15

REMOVAL OF PERCHLORATE FROM DRINKING WATER AND ION-EXCHANGE REGENERANT BRINES

Chulheung Bae, Brian Dougherty and Stephen Harrison

Electrochemical Design Associates Inc., 5705 Hollis Street, Emeryville CA 94608

Abstract: Perchlorate ions from rocket fuel, flare and munitions manufacture and use have escaped into groundwater in several states in the USA. Perchlorate causes alarm because it mimics iodine physiologically and is adsorbed by the thyroid gland, subsequently interfering with the endocrine systems of the brain. Removal of perchlorate to very low ppb is difficult on two fronts: competing ions such as nitrate, sulfate, carbonate etc. are often present at 1000 times higher concentration than perchlorate, and perchlorate is surprisingly stable considering its reputation as a rocket fuel oxidant. Direct electrochemical reduction of perchlorate in the parts per billion range is too slow and expensive to be viable. Ion exchange produces a troublesome disposal problem: either a perchlorate laden ion exchange resin or a brine stream containing high concentrations of perchlorate, nitrate, sulfate and bicarbonate. Electrochemical redox reduction of perchlorate, coupled to ion exchange capture and concentration is an economic and elegant method of dealing with both nitrate and perchlorate, particularly if the kinetics of the reduction process are fast. Perchlorate is surprisingly stable to reduction at a reducing cathode and with common reducing redox ions such as Cr^{2+} , Fe^{2+} . The reaction of perchlorate with Ti^{3+} is well documented in the literature, but the kinetics are slow in common solutions. In our latest study we have discovered that the reaction of perchlorate with titanium ions in methanesulfonic acid is very fast. We describe the laboratory experiments and pilot plant field trials in California that demonstrate the utility of this method for removing perchlorate and nitrate directly from drinking water and from regenerant brines from ion exchange systems.

Key words: perchlorate; ion-exchange; brine; removal; electrochemical destruction; groundwater.

1. INTRODUCTION

Electrochemical Design Associates, Inc. has developed a series of electrochemical technologies to deal with toxic oxyanions in drinking water. Our target ions have been arsenic, nitrate, perchlorate, borate and chromate. Two of these technologies are now commercial and are described elsewhere (Clarke et. al. 2002; Clarke et. al. 2004). The common thread in these developments has been the use of electrons to collect and minimize the waste from the process by collecting or destroying the toxic anion. In this paper, the removal and destruction of perchlorate are described and discussed.

Perchlorate is a common constituent in rocket fuels and munitions manufacture and has escaped into the ground water in many states in the USA. This is causing alarm as perchlorate mimics iodine physiologically and is taken up by the thyroid gland in humans. The EPA has set a limit for perchlorate at 24.5 ppb; several states have set lower limits. California, in particular, has an action

limit of 6 ppb for drinking water supplies. In several parts of CA, notably the San Gabriel Valley region, perchlorate has been detected in the drinking water supply at concentrations as high as 50-100 ppb.

Remediation of ground waters and surface waters contaminated with perchlorate is difficult:

1. Removal is required down to parts per billion of perchlorate;
2. The ion is not easily destroyed in an aqueous environment;
3. Nitrate and other anions, which are usually present at concentrations several orders of magnitude higher than perchlorate compete with it during the reduction process.

Ion-exchange (IX) is one possible solution to the perchlorate problem. Non-selective IX resins can be used, but these merely transfer the perchlorate to a waste brine stream which must itself be treated or disposed of. In addition, these resins strip almost all ions from solution, so that the water produced while of high quality must have non-toxic ions added to reduce wear on the downstream piping & plant which deliver water to homes. Perchlorate selective IX resins have a high capacity for perchlorate, but these are not easily regenerated and must be disposed of after a single use.

Direct electrochemical reduction of perchlorate, that is in-situ reduction of perchlorate to chloride on an electrode even if possible, is too expensive, due to the limitations of dealing with very dilute target ions on a two dimensional surface, the electrode. This is a classical dilemma for electrochemical processing. As reactants become dilute mass transfer limitations of electrolytic reactions follows the path of diminishing returns as current efficiency declines and cell voltages increase.

The approach taken is to capture perchlorate by selective IX, concentrate it in the IX column regenerant, and then destroy the perchlorate via reduction to chloride using a redox agent present in the regenerant. The redox reagent can then be regenerated electrochemically, allowing the IX regenerant to be reused.

2. DESCRIPTION OF TECHNOLOGY

2.1 Perchlorate Selective Ion Exchange

Perchlorate selective ion exchange media such as Purolite A530E and Rohm & Haas PWA2 have been widely demonstrated to have high selectivity and capacity for perchlorate. In drinking water applications, these media typically remove perchlorate and some nitrate from drinking water, but do not absorb other ions to any great extent. They are difficult to regenerate, however their capacity for perchlorate is high enough that a use once & discard philosophy is viable in some situations. A second advantage of these resins is that they can capture perchlorate from brine solutions, allowing an additional application for secondary treatment of waste brine regenerant streams from IX systems which use non-selective resins to treat perchlorate contaminated drinking water.

2.2 DePerc™

EDA has developed a two stage process that elutes perchlorate from a perchlorate-selective IX resin and then reduces the eluted perchlorate to chloride using Ti^{3+}/Ti^{4+} redox chemistry. The Ti is cycled electrochemically, giving a closed loop process. This process is the subject of a US Patent Application (Clarke et. al, 2005).

3. LABORATORY STUDIES

3.1 Column Studies

The laboratory phase of the work was performed primarily using column studies to determine the effectiveness of different reagents as regenerants. The IX resins used were Purolite's A530E and Rohm & Haas' PWA2 which offered high selectivity for perchlorate. These resins are considered to be single use resins due to their high selectivity for perchlorate, and are usually incinerated once used.

3.1.1 Preparation of IX Columns

IX columns were prepared by weighing 20 g of the IX resin to be tested into a 2.5 cm diameter, 15 cm tall column. The resin bed depth was 5.5-6 cm. Deionized (DI) water was poured onto the media to assist the initial packing of the column. The resins were used as-received, with no pre-conditioning, other than rinsing with DI water. Between 20 ml and 50 ml of liquid, either the perchlorate inlet solution or DI water, was maintained over the beads at all times.

3.1.2 Loading Solutions

Loading solutions used in the lab phase of the study were prepared from DI water and sodium perchlorate ($\text{NaClO}_4 \cdot \text{H}_2\text{O}$, EM Science, AR grade). Due to the high capacity for perchlorate of the resins chosen, in order to minimize cycling times, loading solutions typically contained 40 mg/l perchlorate. This is 500-1000 times higher than perchlorate concentrations typically found in drinking water, and about 10 times higher than concentrations typically found in regenerant brines. Nevertheless, the data are still relevant since they demonstrated the effectiveness of the regeneration process.

3.1.3 Regenerant Solutions

Solutions tested as regenerants included baseline materials such as 20 wt% sodium chloride, 2M sulfuric acid, 4M methanesulfonic acid, and titanium salts of sulfuric and methanesulfonic acid (MSA). These were prepared by dissolving titanium oxysulfate (TiOSO_4 , Alfa) in DI water, and then acidifying with either sulfuric or methanesulfonic acid (1M Ti, 4M H^+). The TiOSO_4 salt was supplied as a complex with sulfuric acid; the nominal composition was $\text{TiOSO}_4 \cdot 2\text{H}_2\text{O} \cdot \text{H}_2\text{SO}_4$. In addition, to eliminate the effect of sulfate, titanium powder was dissolved in methanesulfonic acid to give titanium methanesulfonate (1M Ti, 4M MSA).

3.1.4 Electrolysis of Ti Regenerant Solutions

A two-chamber electrochemical cell, constructed from polyethylene, was used to reduce the titanium in the regenerant solution from Ti^{4+} to Ti^{3+} . The anode was platinized titanium and the cathode was carbon felt attached to a titanium mesh current collector. The anolyte was 4M methanesulfonic acid; the catholyte was the regenerant solution. A Nafion membrane separated the anode and cathode chambers. Both anolyte and catholyte solutions were pumped through the cell at about 200 ml/min using a peristaltic pump. The nominal electrode surface area was 100 cm^2 ; the current was 4 A. The electrolysis proceeded with nearly 100% faradaic efficiency until most of the Ti^{4+} was reduced to Ti^{3+} ; the end point can be detected by an increase in gas evolution and a change in the color of the solution.

This regenerant solution was used until 2 to 3 g of perchlorate had been desorbed from the IX resin; this was equivalent to 20% to 30% of the Ti^{3+} in solution. It was then returned to the electrochemical cell and electrolyzed until gas was evolved at the cathode. The regenerant was then used for additional regenerations.

3.1.5 Column Cycling

The perchlorate solution was pumped from the reservoir through the IX column from top to bottom, at a flow rate of 60-80 BV/hr. This corresponds to a flow velocity of about 3 m/hr. Loading continued until the perchlorate concentration in the effluent was equal to that of the influent. The resin bed was gravity drained, and the column connected to the regenerant system.

The regenerant solution was placed in a stirred, heated reservoir maintained at 45 °C throughout the regeneration. In most experiments, the regenerant was pumped from the bottom to the top of the column; i.e counter current to loading. The flow rate was about 60 BV/h and regeneration proceeded for 24-25 hours. The total volume of regenerant was about 30 BV. A few experiments were performed in single pass mode, and the effluent from the top of the column was collected in a separate container. The flow rate was the same as for the recirculating case, but the total number of bed volumes of regenerant used was larger, 120 BV.

After regeneration, the IX column was pumped dry of regenerant and rinsed with one to two BV of DI water to remove traces of the regenerant solution. This step was repeated until the pH of the effluent was between 3 & 4. Altogether, depending on how well the IX resin is drained each time, this requires 5 to 10 BV of DI water.

Samples were taken at intervals throughout the process and analyzed for perchlorate using Ion Chromatography.

3.2 Results & Discussion

The column tests used high inlet perchlorate concentrations as a means to speed up the loading process. A530E was loaded at 40 ppm influent perchlorate; PWA2 was loaded at 100 ppm for the first four cycles, and at 40 ppm for the others. Columns were loaded until the perchlorate concentration in the effluent equaled that in the influent. Whilst the difference between loading at 40 ppm and 100 ppm is not particularly significant, except that the equilibrium capacity of the resin will be slightly lower at 40 ppm, results at 40 ppm are not necessarily indicative of the capacity of the resin at lower concentrations of perchlorate.

Typical loading curves for Purolite A530E and Rohm & Haas PWA2 IX resins following regeneration via various regenerants are shown in Figures 1 & 2, respectively. It is apparent from these figures that the regeneration efficiency for both resins is fairly poor when NaCl, Ti[IV]OSO₄-H₂SO₄ or Ti[IV]OSO₄-MSA are used. For all three of these regenerants, A530E recovers about 35% of its initial capacity whereas PWA2 recovers about 10%. When the Ti[IV]OSO₄-MSA regenerant is reduced to its Ti[III] form, the regeneration efficiency of A530E improves to about 70%, however no change is seen for PWA2. The best result for both resins was obtained when the Ti regenerant is prepared directly from Ti powder dissolved in MSA. The regeneration efficiency of A530E was close to 100%, while that of PWA2 improved to 45%. It is also apparent from these tests that the A530E IX resin is more easily regenerated in general than the PWA2 resin. Note that the column reload for Ti[III]-MSA in Figure 2 has a lower inlet concentration than the other curves in this figure, so that it takes more bed volumes to load the column in this case.

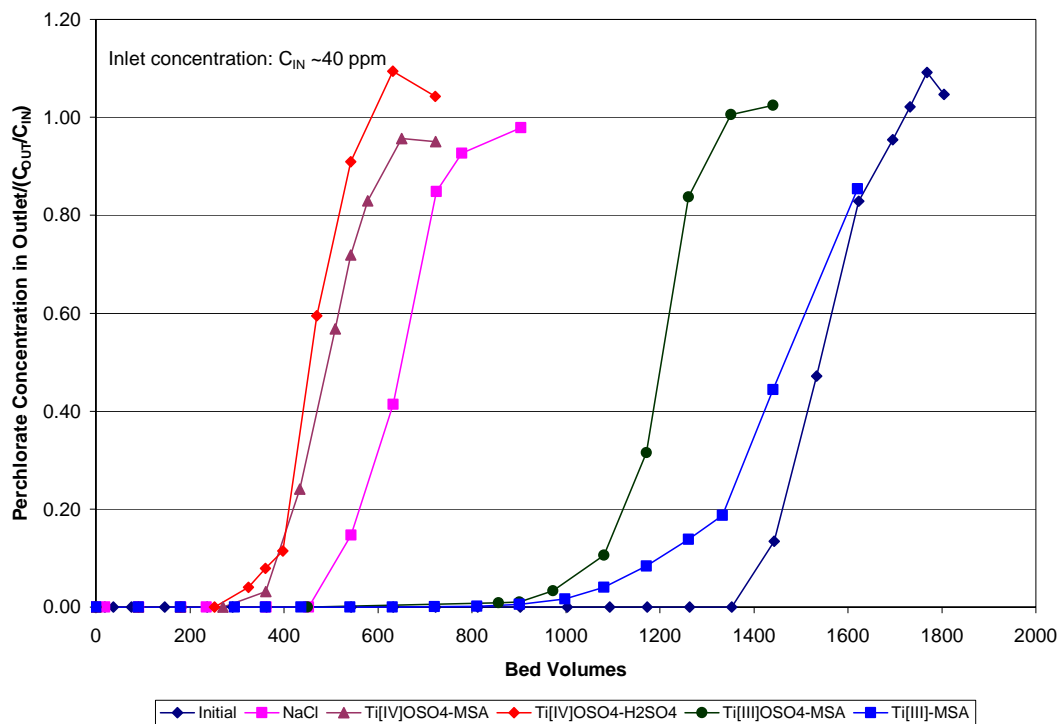

Figure 1. Perchlorate loading curves for Purolite A530E IX resin

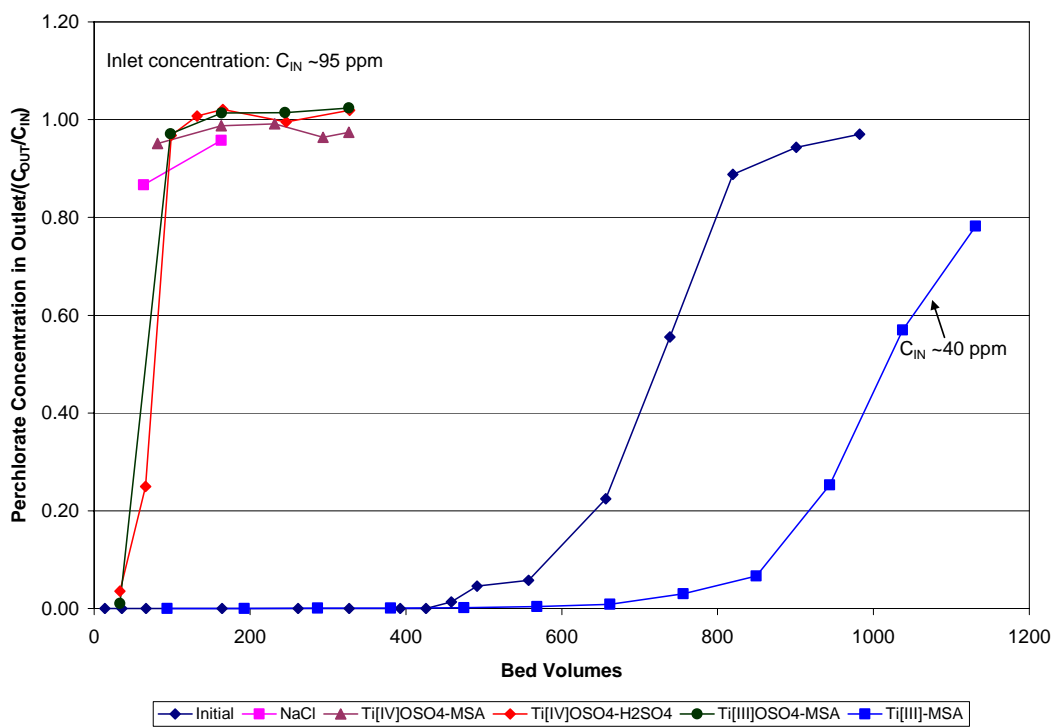

Figure 2. Perchlorate loading curves for Rohm & Haas PWA2 IX resin

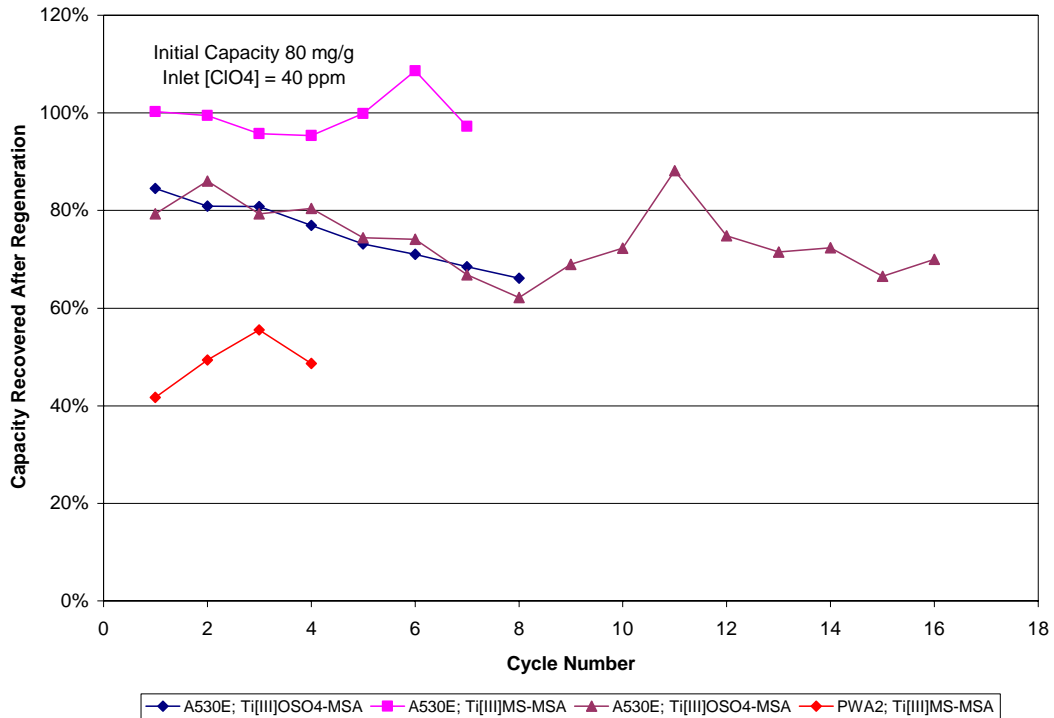

Figure 3. Capacity of IX resin on cycling

Figure 3 shows the effect of repeated cycling on the capacity of the two IX resins studied. For Ti[III]OSO₄-MSA, the efficiency of regeneration of A530E was about 80% on the first cycle, but decreased to about 70% after 8 cycles, where it remained through at least 16 cycles. Figure 3 shows the first eight cycles for two different columns of the A530E IX resin for this regenerant. After 8 cycles, one column was switched to TiMS₃-MSA. Using this regenerant, 95%-100% of the initial capacity was recovered through 8 cycles. For the PWA2 resin, the regeneration efficiency is about 50% using the TiMS₃-MSA regenerant, and varies a more during cycling.

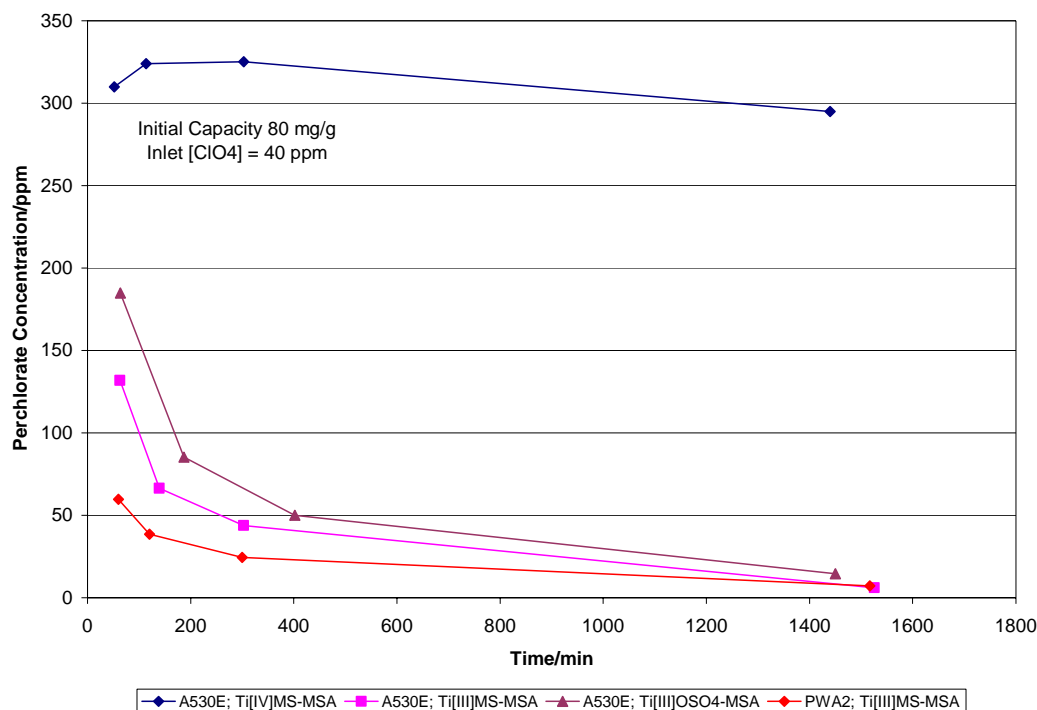

Figure 4. Perchlorate concentration in regenerant

Figure 4 shows the concentration of perchlorate measured in the regenerant during regeneration of the A530E resin. When the Ti[IV] form of was used, perchlorate was not reduced and reached a maximum concentration of 300-320 ppm after less than 60 minutes of contact with the IX resin. Presumably this represents the steady state concentration of perchlorate in the regenerant, for this resin, loaded at 40 mg/l perchlorate. When the Ti[III] version was used, the maximum perchlorate concentration was achieved at the start of the regeneration cycle, and decreased with time as the perchlorate is reduced, ultimately to chloride. The reduction in perchlorate concentration is significantly faster when only MSA is present (i.e. no oxysulfate), implying that the reaction rate between Ti^{3+} and perchlorate is faster in this case. For PWA2, the perchlorate concentrations are lower because the regeneration is less efficient.

4. PILOT-SCALE FIELD TRIALS

Baldwin Park Operable Unit LLC (BPOU) operates a water treatment system known as ISEP to remove perchlorate from groundwater as part of a process to produce potable water. This process generates a 25-70 gpm waste brine stream that contains 4 to 5 ppm perchlorate in addition to other ions. This waste stream is currently untreated and sent to the local sewer. Regulatory changes in the near future mean that this practice needs to be modified, and the perchlorate must be removed from the brine prior to discharge to the sewer.

4.1 Pilot Plant Description

In collaboration with Rohm & Haas, an IX system was designed to remove perchlorate from the brine waste stream using Rohm & Haas's PWA2 perchlorate selective resin. Figures 5 through 7 are pictures of this system as installed at BPOU. The system comprised two 1.3 ft³ IX vessels, each containing 1.1 ft³ of resin. The columns were operated in series. Only the first column was regenerated; the second was used as a polishing column. The objective of the test was to operate the system through ten regeneration cycles with no perchlorate leakage from the second IX unit.



Figure 5. Ion-exchange subsystem of unit deployed at Baldwin Park

Waste brine from the ISEP process was preconditioned by feeding it into a holding tank to allow dissolved gasses (mainly carbon dioxide) to escape. It was then pumped through the ion exchange system at an average flow rate of 38 BV/h. After loading for eight hours, the first second IX column was isolated from the rest of the system, and the first IX column was drained of brine and connected to the regenerant system. Regenerant was pumped from its storage tank through the first IX column for 16 hours. At the end of the regeneration cycle, the regenerant was displaced back to the storage tank using DI water. Column 1 was then rinsed with DI water, and ready for the next cycle.



Figure 6. Electrochemical destruction unit for regenerant recycle

The regenerant was recycled by electrolysis in the electrochemical destruct unit (EDU). The EDU was essentially a larger sized version of the lab cell described above. For this demonstration, the regenerant was prepared from the TiOSO_4 salt described earlier, acidified with methanesulfonic acid.

4.2 Results & Discussion

Three series of tests were run at BPOU. The first two series demonstrated that perchlorate could be removed from brine using selective ion-exchange, that the IX resin could be regenerated, and that the perchlorate could be destroyed in the regenerant. However, these two series did not meet the project objective due to premature leakage of the perchlorate. This was due in part to poor design of the IX system and because of contamination of the IX resin. Thus the system was redesigned before the third series of experiments.

The perchlorate concentrations at the inlet and the outlets to each of the IX columns during the third series of tests are presented in Figure 7 with respect to elapsed loading time. It should be remembered that loading cycles lasted for eight hours, so Figure 7 summarizes the results for all ten cycles.

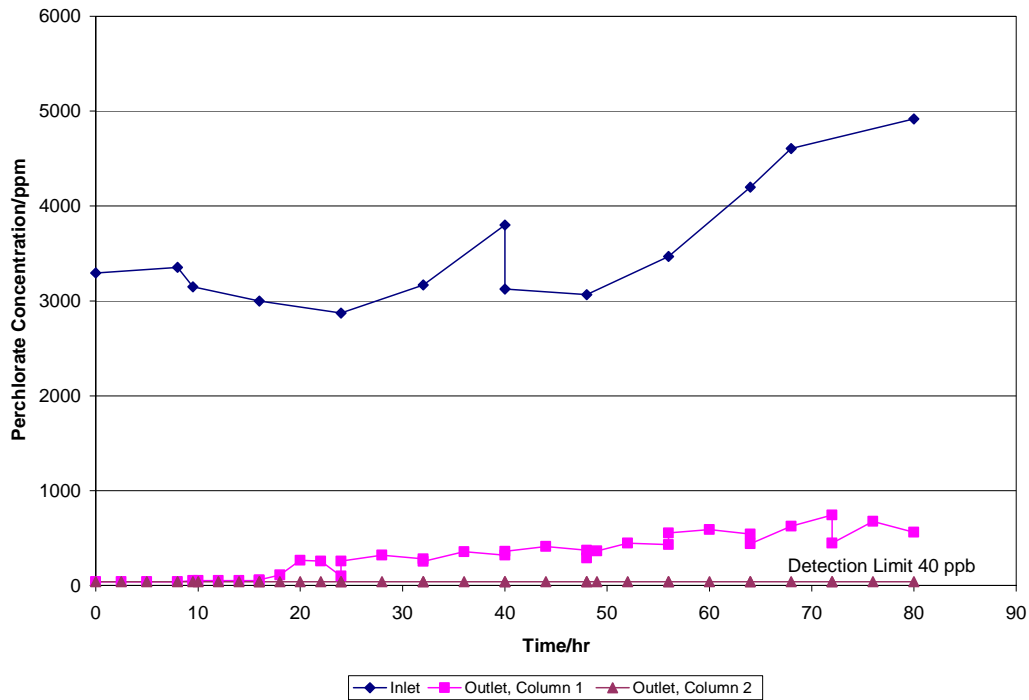

Figure 7. Perchlorate concentrations in brine during loading cycles

The feed concentration ranged from 3000 ppb to 5000 ppb, and was higher towards the end of the test, especially the last three cycles. The concentration of perchlorate in the outlet from the second IX column was less than 40 ppb, the detection limit for this trial. (The detection limit of the IC is 4 ppb, but the high background conductivity of the brine matrix requires a dilution factor of ten to obtain quantitative data, hence the 40 ppb detection limit).

The perchlorate concentration at the outlet from the first IX column was at the detection limit for the first two cycles, but subsequently the bleed increased to about 600 ppb by cycle 8, at which point it stabilized during the last two cycles despite the higher inlet concentration. Figure 8 shows the bleed rate as a percentage of the inlet concentration. The small amount of bleed shown in these data is typical of a process in which the column is undergoing an incomplete regeneration. It also appears from the data that the bleed rate has begun to approach a steady state, although more cycles are needed to confirm this. The perchlorate leaking from column 1 can therefore be captured on a second ion exchange unit which could be regenerated or disposed of, depending on economics.

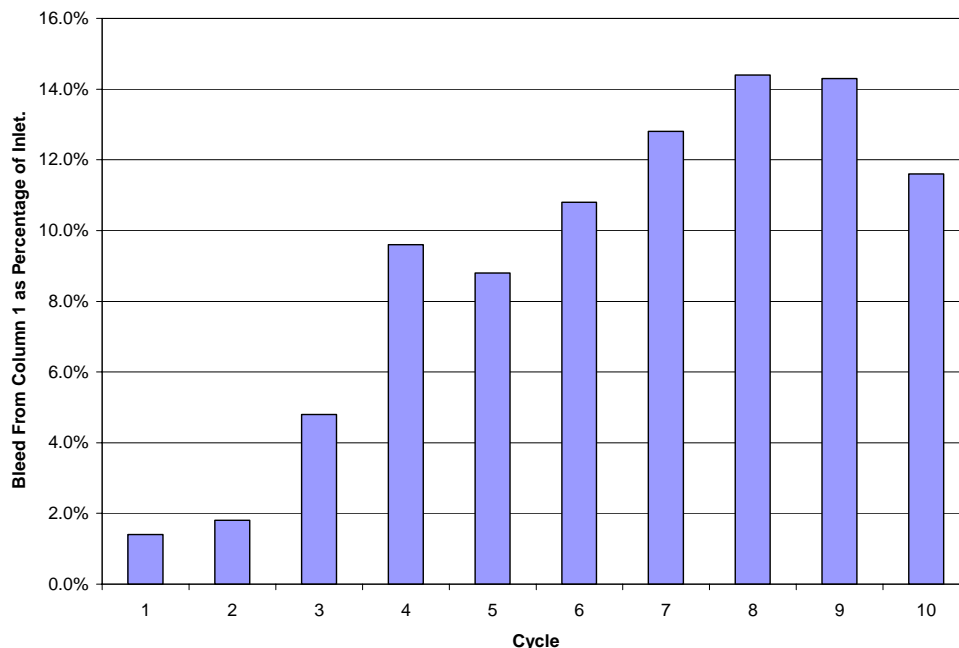

Figure 8. Bleed of Perchlorate From IX Column 1

During this series, the average inlet concentration of perchlorate was 3.6 ppm perchlorate. Given the flow rate (19 lpm) and total operating time (80 hours), the total volume treated was around 91,000 liters. Therefore, the total quantity of perchlorate passed through the IX system was 328 g. Analysis of the resin from the two IX columns following the test showed that the amount of perchlorate remaining on column 1 was 1.5 g/l of resin, or 57 g, and the amount remaining on column 2 was 0.78 g/l or 23 g. Thus of the 328 g of perchlorate which entered the system, 80 g remained on the columns while 248 g of perchlorate was removed during regeneration. This would be the equivalent of 70 ppm perchlorate in the regenerant (3500 liters) if the perchlorate did not react with Ti, well above the 1.2 ppm detection limit for this solution. No perchlorate was detected in the regenerant. It can therefore be concluded that the ion-exchange resin was regenerated, and that a significant portion of the perchlorate captured by the resin was destroyed during the process.

5. CONCLUSIONS

On the basis of these data, the demonstration achieved the project success criteria (zero bleed from column 2). It is however recognized that the process needs further improvement, in particular to minimize bleed from Column 1 so that the size of any polishing column can be reduced. In particular, a more complete regeneration of the IX resin would lower the bleed significantly. It should be noted that the regenerant used in the field study was not the best one from the lab data, due to the lack of commercially available TiMS_3 salts.

In our opinion, the process has been successfully scaled-up from the laboratory in the most difficult of effluents – perchlorate-containing brine. The process is even more effective when used with water rather than brine. In this case the perchlorate leakage is non-existent and a polishing column, though desirable, is not essential to the process.

ACKNOWLEDGEMENTS

The authors would like to thank Rohm & Haas for their collaboration during the field trial portion of this work. We would also like to thank Geomatrix and BPOU LLC for funding the study, and RC Forster for logistical support at the site. We also acknowledge the support of Scott Stevenson, Roderick Murdock and others who operated & installed the equipment at BPOU.

REFERENCES

- Clarke S.R., Clarke R.J., Murdock R., Butler, C., Mohanta, S. 2002. Water Treatment Method and Apparatus. US Patent #6383395.
- Clarke R.L., Harrison, S., Jain, S. 2004. Electrochemical Nitrate Destruction. US Patent Application PCT/US2004/042961 B1
- Clarke R.L., Harrison, S., Dougherty, B.J., 2005. Perchlorate Destruction. US Patent Application PCT/US2005/0239632 A1

Chapter 16

LESSONS LEARNED FOR FUTURE DESIGNS FROM THERMAL TREATMENT OF PERCHLORATE IN SOIL

Shouvik Gangopadhyay¹, Paul Nixon², and Scott C. Michalak³

¹ECC, PB 519 Gaffney Road, Camp Edwards, MA 02542; ²Impact Area Groundwater Study Program, 1803 West Outer Road, Camp Edwards, MA 02542; ³United States Army Corps of Engineers New England District, 696 Virginia Road, Concord, MA 01742-2751

Abstract: A soil remediation project using *ex-situ* thermal desorption to remove explosive compounds was modified at the latter stages of planning to include treatment of perchlorate. The design-build approach consisted of a bench scale study, which verified the treatability of perchlorate at baseline treatment conditions, and pilot scale studies, which helped refine the process parameters for full-scale treatment. During initial full-scale operations, a high number of treated soil batches failed to meet the project treatment criteria. Analytical results of samples collected from various stages along the treatment train indicated a potential for perchlorate contamination to by-pass the primary treatment process. Slower feed rates and higher operating temperatures did not show any conclusive positive impact on treatment efficiency. Recycling the particulates from the air pollution control equipment back into the feed soil was initially considered, but was deemed infeasible with the current equipment design configuration. A cost-effective solution was achieved by reducing the size of the treated soil sample batch volume, thereby reducing the amount of soil requiring re-treatment when occasional failures occurred. Future plant designs intended for treatment of perchlorate could potentially improve destruction efficiency by recycling particulates to the beginning of the process instead of the treated soil discharge.

Key words: soil remediation, treatment, pilot-scale, process improvement, explosive compounds, RDX, HMX, perchlorate.

1. INTRODUCTION

Several sites at a military installation were found to contain surface and sub-surface contamination consisting of perchlorate and the explosive compounds hexahydro-1,3,5-trinitro-1,3,5-triazine (RDX) and octahydro-1,3,5,7-tetranitro-1,3,5,7-tetrocine (HMX) in a wide range of concentrations. Remediation of these sites was deemed necessary as the groundwater beneath the sites is classified as a sole source drinking water aquifer.

Once the soils were excavated, several alternatives were available for managing the excavated soils. These included landfill disposal, soil washing, and thermal desorption. Taking into consideration the expected volume of soil requiring treatment, the thermal desorption alternative became the more economically attractive alternative. Additionally, soil washing was expected to be ineffective for chunks of explosive materials found in some of the source area sites. Furthermore, on-site treatment eliminated the potential liabilities typically associated with landfill disposal.

The volume of soil excavated from the sites and treated by a thermal desorption process was approximately 40,000 cubic yards (cy). The remediation goal was agreed on with the regulatory community and set based on the reporting limit of the available laboratory analyses— 4 ppb for perchlorate based on EPA Method 314.0 and 120 ppb for the explosive compounds RDX and HMX based on EPA SW846/Method 8330. Since that time, the remediation soil standards proposed by the

state regulatory agency for perchlorate and explosives compounds (RDX and HMX) are orders of magnitude higher than the agreed on remediation goals for this project.

Environmental Chemical Corporation (ECC) was contracted by the United States Army Corps of Engineers (USACE) to mobilize and operate a Thermal Treatment Unit (TTU) at the site. This paper provides a general description of the system, the studies conducted to determine feasibility of the system, and lessons learned from the TTU operations. This project was the first known full-scale application of thermal destruction of perchlorate in contaminated soil using a TTU.

2. TREATMENT PROCESS

The TTU consists of a solids treatment system and an air pollution control (APC) system. The solids treatment system contains a soil feed system, direct-fired rotary drum (dryer), and product discharge system. The APC system contains a cyclone, thermal oxidizer, evaporative cooling chamber, bag house, induced draft blower, and a stack. The fuel source for the burners is vaporized liquid propane. The process flow diagram is shown in Figure 1.

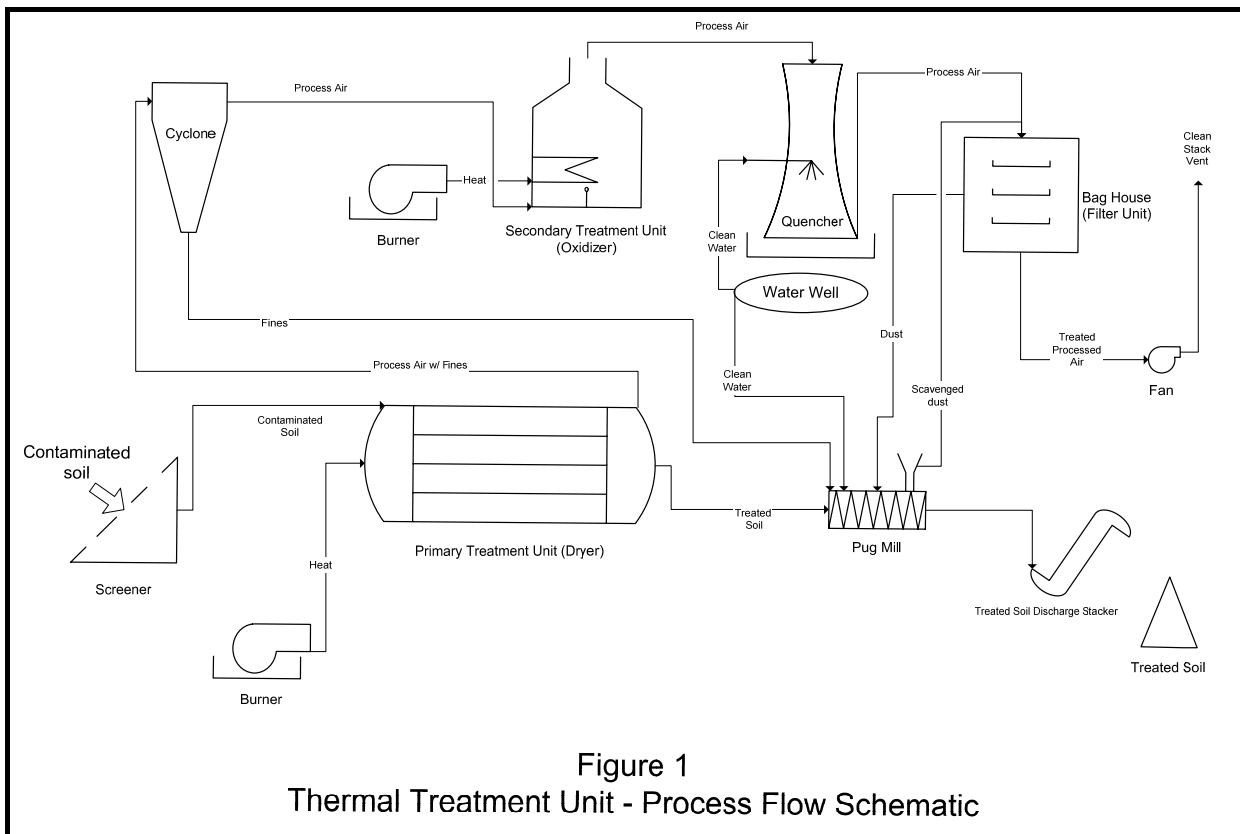

Figure 1.

Soil is prepared for treatment by initially screening out items greater than 1 inch in diameter using mechanical means. Contaminants are removed from the soil in the parallel flow, direct-fired rotary drum. In the parallel flow design configuration, soil particulates travel the entire length of the drum during which time they are heated to, and maintained at, the target temperature until they are discharged to the pugmill.

The pugmill mixes the hot treated soil with cooling water. This re-humidification process controls dust emissions and prepares the soil for future handling. A negative draft is induced on the headspace of the pugmill and any steam generated within the pugmill is vented to the bag house.

Exhaust gases leaving the rotary drum pass through a cyclone, which is the primary control for air entrained particulates. Particulates removed in the cyclone are gravity fed to the pugmill where they are blended into the treated soil before exiting the system.

The exhaust gas leaving the cyclone continues to a thermal oxidizer which heats the gas to a specific temperature, determined on a contaminant and site specific basis, in order to destroy the remaining contaminants. Before entering the baghouse, the hot gases exiting the thermal oxidizer are cooled with air-atomized water spray nozzles in the evaporative cooling chamber to a temperature below 450°F.

The bag house is designed to remove fine particulates entrained in the exhaust gases. The fines form a cake on the bag surface, which is periodically cleaned by a pulse of air. A screw auger transfers these fines to the soil discharge pugmill and blends the fines back into the treated soil. An induced draft (ID) blower located after the bag house is used to maintain a negative pressure on the air pollution control system. Clean exhaust gases are emitted to the atmosphere through a vertical stack.

3. TREATABILITY STUDY

Full-scale operations at previous project sites had established that an operating temperature of approximately 650°F was sufficient to remove explosive contaminants (predominantly RDX and HMX). However, perchlorate had previously never been treated in a thermal desorption process. A literature search revealed that ammonium perchlorate sublimates and undergoes thermal destruction at about 725°F.

A treatability study was designed to determine the target operating parameters for full-scale treatment conditions. The test program was carried out at Hazen Research, Inc., Golden, Colorado. The apparatus used consisted of a cylindrical quartz rotary kiln in a muffle furnace, with all off-gases collected in a 2-stage condensing system that separated the condensed water vapor and particulates from the non-condensable gases. The test soils were carefully weighed and spiked with a known quantity of perchlorate and homogenized before adding the soil to the reactor. The rotary kiln reactor was rotated during the test to simulate full-scale operation, and heated up at a controlled rate to the desired operating temperature. When the rotary kiln reactor and soils reached the desired temperature, a timed run was initiated. An outline of the tests is shown in Table 1. All products (soils, particulates, water vapor and non-condensable gases) were analyzed for residual perchlorate. Two sets of tests were carried out with the soils spiked to 100 ppb (low level) and 100,000 ppb (high level).

Table 1. Operating Conditions, Treatability Study

| Operating Condition Number | Concentration of Perchlorate in Feed Soil (ppb) | Treated Soil Temperature (OF) | Residence Time at Temperature | Oxygen Content |
|----------------------------|---|-------------------------------|-------------------------------|----------------|
| 1 | 100,000 | 650 | 10 minutes | > 7% |
| 2 | 100,000 | 900 | 10 minutes | > 7% |
| 3 | 100,000 | 1150 | 10 minutes | > 7% |
| 4 | 100,000 | 650 | 30 minutes | > 7% |
| 5 | 100,000 | 1150 | 30 minutes | > 7% |
| 6 | 100,000 | 900 | 10 minutes | <1% |
| 7 | 100 | 650 | 10 minutes | > 7% |
| 8 | 100 | 900 | 10 minutes | > 7% |
| 9 | 100 | 1150 | 10 minutes | > 7% |
| 10 | 100,000 | 725 | 10 minutes | > 7% |
| 11 | 100,000 | 775 | 10 minutes | > 7% |

°F = degrees Fahrenheit

ppb = parts per billion

Table 2 shows the results obtained from analysis of the soil constituents and Table 3 shows the analytical results from the condensates collected during each run. The analytical data indicate that explosive compounds were destroyed under all conditions tested. Perchlorate was removed in six of the initial nine conditions evaluated. The tests which failed were at the lowest treatment temperature,

650°F. Since perchlorate was removed successfully at the two higher operating temperatures of 900°F and 1150°F, two additional tests were run at intermediate temperatures of 725°F and 775°F. Traces of perchlorate were present in the 725°F treated soils but none at 775°F.

Table 2. Soil Analytical Results, Treatability Study

| Description | Pre-spike and Pre-Test | Run 1, 100 mg/kg, 650 °F, 10 min., >7% O ₂ | Run 2, 100 mg/kg, 900 °F, 10 min., >7% O ₂ | Run 3, 100 mg/kg, 1150 °F, 10 min., >7 % O ₂ | Run 4, 100 mg/kg, 650 °F, 30 min., >7% O ₂ | Run 5, 100 mg/kg, 1150 °F, 30 min., >7% O ₂ | Run 6, 100 mg/kg, 900 °F, 10 min., <1% O ₂ | Run 7, 0.1 mg/kg, 650 °F, 10 min., >7% O ₂ | Run 8, 0.1 mg/kg, 900 °F, 10 min., >7% O ₂ | Run 9, 0.1 mg/kg, 1150 °F, 10 min., >7% O ₂ | Run 10, 100 mg/kg, 725 °F, 10 min., >7% O ₂ | Run 11, 100 mg/kg, 775 °F, 10 min., >7% O ₂ |
|-------------|------------------------|---|---|---|---|--|---|---|---|--|--|--|
| Units | µg/kg | µg/kg | µg/kg | µg/kg | µg/kg | µg/kg | µg/kg | µg/kg | µg/kg | µg/kg | µg/kg | µg/kg |
| Perchlorate | 3.5J | 51 | 1.3U | 1.3U | 25 | 1.3U | 1.3U | 41 | 1.3U | 1.3U | 74 | 1.3U |
| HMX | 120U | 120U | 120U | 120U | 120U | 120U | 120U | 120U | 120U | 120U | 120U | 120U |
| RDX | 120U | 120U | 120U | 120U | 120U | 120U | 120U | 120U | 120U | 120U | 120U | 120U |

J = estimated result U = non-detect result
 °F=degrees Fahrenheit mg/kg = milligrams per kilogram

Table 3. Condensate Analytical Results, Treatability Study

| Description | Detection Limit | Run 1, 100 mg/kg, 650 °F, 10 min, >7 % O ₂ | Run 2, 100 mg/kg, 900 °F, 10 min, >7 % O ₂ | Run 3, 100 mg/kg, 1150 °F, 10 min, >7 % O ₂ | Run 4, 100 mg/kg, 650 °F, 30 min, >7 % O ₂ | Run 5, 100 mg/kg, 1150 °F, 30 min, >7 % O ₂ | Run 6, 100 mg/kg, 900 °F, 10 min, <1 % O ₂ |
|-------------|-----------------|---|---|--|---|--|---|
| Units | µg/L | µg/L | µg/L | µg/L | µg/L | µg/L | µg/L |
| Perchlorate | 0.35 | 160 | 110 | 140 | 140 | 150 | 220 |

µg/L = micrograms per liter °F = degrees Fahrenheit

The condensed streams collected from the rotary kiln reactor were analyzed and showed that less than 0.05 percent of the perchlorate anions in the feed soils were present in the condensate. The treatability study thus successfully demonstrated that perchlorate contaminated soils can be thermally treated and that > 99.9% of perchlorate was decomposed in the rotary kiln operating at 775°F or higher. The remaining 0.01% balance would be destroyed in the full scale system in the thermal oxidizer operated at 1400°F.

4. PILOT AND PERFORMANCE TESTING

During shakedown operations, the initial set point for the soil discharge temperature was 775°F, based on the treatability study results for perchlorate. TTU performance is often system specific and each unit must be optimized to ensure adequate performance. Furthermore, the site soils were generally wet (up to 18% moisture by weight). Drying the soil requires approximately half of the residence time, leaving the remaining half for thermal destruction of the contaminants.

Twenty spike tests were conducted to determine the minimum temperature and other operating parameters required to ensure the treatment of all contaminants. The feed rates for the testing period varied between 20 to 40 tons per hour, at an approximate residence time of 13 minutes. Measured amounts of the spiking agents were added based on feed rate. Results from the tests are included in Table 4.

Table 4. Spike Test Results For Perchlorate

| Test # | Feed Perchlorate Concentration (part per billion) | Treated Soil Perchlorate Concentration (part per billion) | Minimum Temp Goal (F) | Average Temp (F) | Average Feed Rate (tons per hour) | Treatment Efficiency |
|--------|---|---|-----------------------|------------------|-----------------------------------|----------------------|
| 1 | 100,000 | 45 | 775 | 807 | 25 | 99.955% |
| 2 | 82,000 | 4500 | 725 | 756 | 30 | 94.543% |
| 3 | 121,000 | 3500 | 675 | 705 | 21 | 97.102% |
| 4 | 76,000 | 280 | 825 | 832 | 35 | 99.633% |
| 5 | 83,000 | 20 | 875 | 886 | 33 | 99.976% |
| 6 | 77,000 | 88 | 825 | 833 | 35 | 99.885% |
| 7 | 82,000 | 13 | 875 | 886 | 33 | 99.984% |
| 11 | 1,000 | <0.8 | 925 | 958 | 30 | 100.000% |
| 12 | 1,100 | <0.9 | 900 | 911 | 26 | 100.000% |
| 13 | 900 | <1.0 | 875 | 877 | 25 | 100.000% |
| 14 | 1,200 | <1.1 | 850 | 853 | 26 | 100.000% |
| 15 | 1,100 | 3.5 | 800 | 804 | 27 | 99.683% |
| 16 | 110,100 | 3.3 | 925 | 936 | 29 | 99.997% |
| 17 | 109,000 | 13 | 900 | 912 | 33 | 99.988% |
| 18 | 102,700 | 65 | 875 | 884 | 35 | 99.937% |
| 19 | 111,300 | 140 | 850 | 857 | 35 | 99.874% |
| 20 | 105,500 | 340 | 800 | 807 | 37 | 99.678% |

The first ten tests involved spiking feed soil with high concentrations of reagents (approximately 100 parts per million). HMX was successfully treated in all tests at temperatures ranging from 600°F to 700°F. Results from the first three tests (1 through 3), run at minimum operating condition of 775°F, 725°F and 675°F respectively, indicated that all perchlorate was not adequately removed from the feed soil. Subsequently, the remaining four tests (4 through 7) were run at minimum operating temperatures of 825°F and 875°F. Analytical results showed that the treated soils still contained perchlorate at levels above the 4 ppb project remediation goal. It should be noted that the control of treatment temperature during this early stage of shakedown testing was inconsistent and may have contributed to inefficiencies in treatment. The treatment temperature control was improved in subsequent operations after the burner control components were further tuned.

Spiking events eleven through twenty were designed to determine both the treatment temperature for perchlorate and the effect that feed concentrations had on the treatment of perchlorate. These tests were run with minimum temperatures of 925, 900, 875, 850, and 800°F, respectively, repeated for two different types of feed soils. Five of these events (16 through 20) were run with native soils spiked with a high concentration (approximately 100 ppm) of perchlorate and the other five (11 through 15) were run with native soils spiked with a low concentration (approximately 1 ppm of perchlorate). Results (Table 4) showed that the high concentration spiked soil was treated to below the project remediation goal only at the highest temperature (Test 16 at 925 °F). The low concentration spiked soils were successfully treated to below the project remediation goal in all the tests.

Figures 2 and 3 illustrate the variation of removal efficiency of perchlorate with respect to average operating temperatures. Removal efficiency of the soils containing low concentrations of perchlorate rose sharply between 800 and 850°F. Beyond 850°F, perchlorate was not detected in any of the treated soils samples. Removal efficiency of the soils containing a higher concentration of perchlorate rose sharply in the beginning, and continued to rise gradually after 800°F.

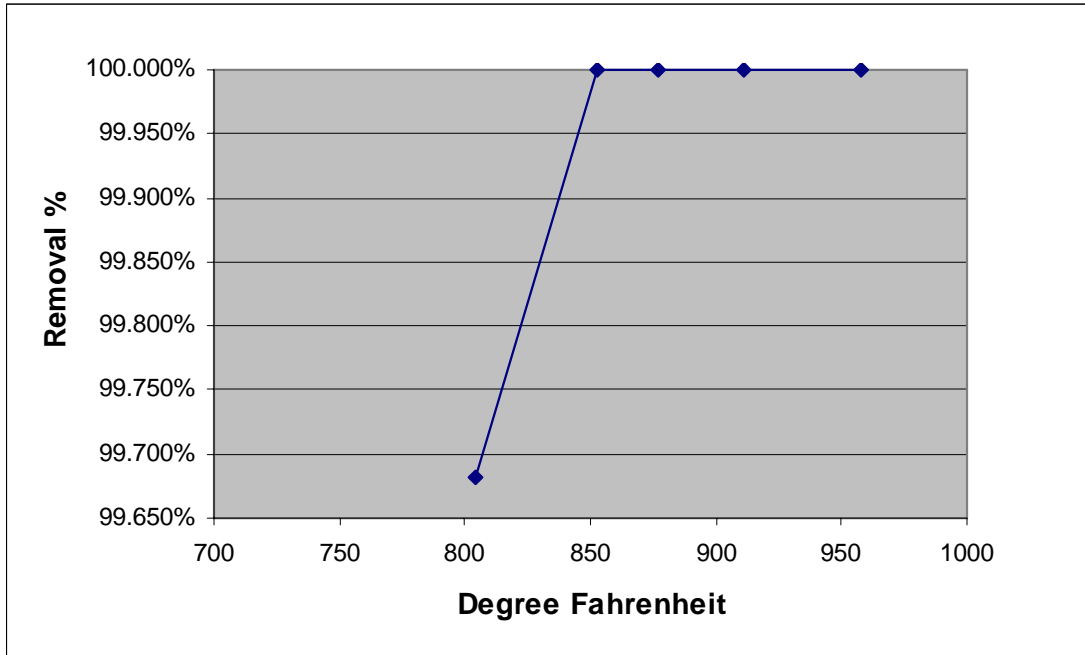

Figure 2. Removal Efficiency vs Temperature (Low Spike Concentration)

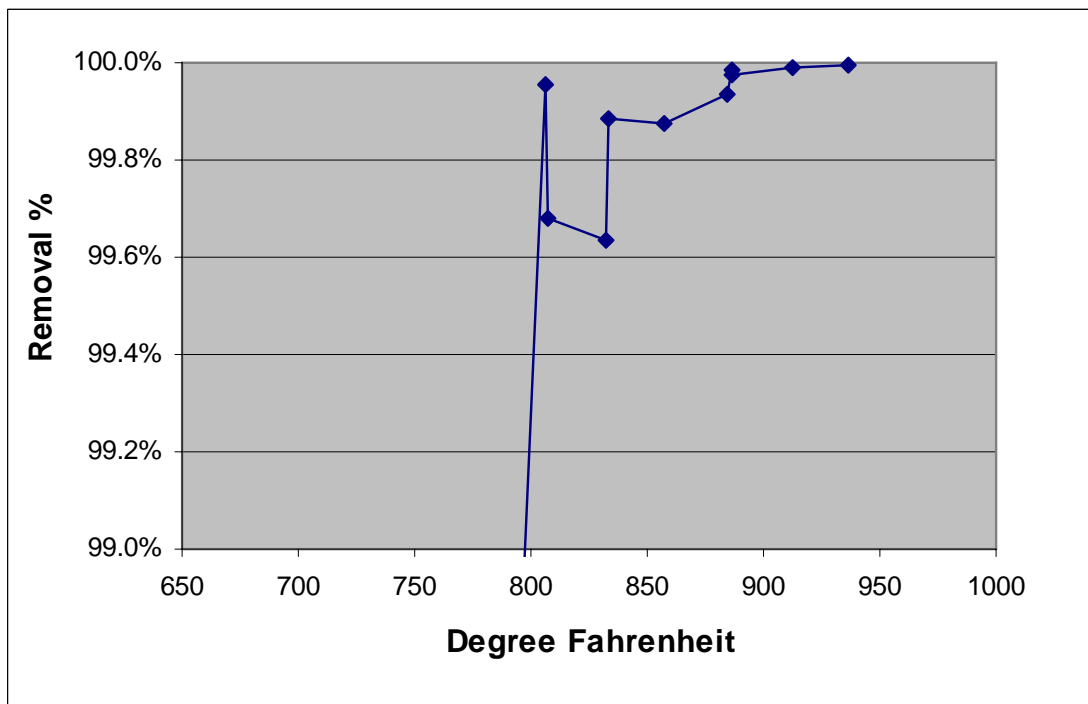

Figure 3. Removal Efficiency vs Temperature (High Spike Concentration)

Once operating conditions were sufficiently field tested during this period, the treatment unit underwent a proof of performance (POP) test. The primary objectives of the performance test, conducted over a three day period, were to demonstrate that a) the air emissions would meet the criteria established by the state Air Permit, b) the TTU would meet the project specified treatment criteria for soil, and c) the equipment could be safely operated in a controlled manner.

Feed material for the test included approximately 2,500 tons of soil from the contaminated sites and treated soil from spiking events that had failed the treatment criteria. A portion of the soil was also spiked with target compounds in order to demonstrate the effectiveness of the thermal treatment system's air pollution control system. Composite samples of the feed material were collected and analyzed at a rate consistent with treated soil verification testing to verify the levels of the contaminants of concern before treatment and to establish a baseline for air permit emissions calculations. Samples were also collected from the cyclone discharge and from the baghouse dust stream prior to being mixed with the treated soil.

Analytical results of samples from the feed soil, treated soil, and baghouse and cyclone dust are presented in Tables 5, 6 and 7, respectively. The analytical results indicated that the pre-spiked feed soil for the POP had varying concentrations of perchlorate ranging from 46 to 100 ppb. The major contributing source of perchlorate in the feed soil was from recycled stockpiles that had previously failed to meet the targeted cleanup standard for perchlorate during the spike tests.

Table 5. POP Test Feed Soil Summary Data

| Sample ID | RDX (ppb) | HMX (ppb) | Perchlorate (ppb) | Moisture % |
|---------------|-----------|-----------|-------------------|------------|
| Day 1 | | | | |
| FS033104-019 | 120U | 120U | 100 | 14 |
| FS033104-020 | 120U | 120U | 91 | 14 |
| Day 2 | | | | |
| FS040104-024 | 120U | 120U | 66 | 18 |
| FS040104-027 | 120U | 120U | 57 | 16 |
| FS0401044-030 | 120U | 120U | 46 | 17 |
| Day 3 | | | | |
| FS040204-033 | 120U | 140 | 50 | 14 |
| FS040204-036 | 330 | 120U | 63 | 14 |

Table 6. POP Test Treated Soil Summary Data

| Sample ID | RDX (ppb) | HMX (ppb) | Perchlorate (ppb) | Moisture % |
|--------------|-----------|-----------|-------------------|------------|
| Day 1 | | | | |
| TS033104-019 | 120U | 120U | 4.3J | 12 |
| TS033104-020 | 120U | 120U | 5.8U | 14 |
| Day 2 | | | | |
| TS040104-024 | 120U | 120U | 3J | 15 |
| TS040104-025 | 120U | 120U | 3.5J | 13 |
| TS040104-026 | 120U | 120U | 3.3J | 14 |
| TS040104-027 | 120U | 120U | 1.9J | 12 |
| TS040104-028 | 120U | 120U | 4.3J | 11 |
| TS040104-029 | 120U | 120U | 10 | 14 |
| TS040104-030 | 120U | 120U | 2.8 | 18 |
| TS040104-031 | 120U | 120U | 2.8J | 14 |
| TS040104-032 | 120U | 120U | 5.9U | 15 |
| Day 3 | | | | |
| TS040204-033 | 120U | 120U | 5.6U | 11 |
| TS040204-034 | 120U | 120U | 5.6U | 11 |
| TS040204-035 | 120U | 120U | 5.7U | 13 |
| TS040204-036 | 120U | 120U | 5.7U | 12 |
| TS040204-037 | 120U | 120U | 5.6U | 10 |
| TS040204-038 | 120U | 120U | 5.7U | 12 |
| TS040204-039 | 120U | 120U | 5.6U | 11 |
| TS040204-040 | 120U | 120U | 5.7U | 12 |
| TS040204-041 | 120U | 120U | 5.7U | 12 |

Table 7. POP Test Baghouse/Cyclone Summary Data

| Sample ID | RDX (ppb) | HMX (ppb) | Perchlorate (ppb) | Moisture % |
|--------------|-----------|-----------|-------------------|------------|
| Day 1 | | | | |
| BD033104 | 120U | 120U | 22 | 2 |
| CD033104 | 120U | 120U | 46 | 0 |
| Day 2 | | | | |

| Sample ID | RDX (ppb) | HMX (ppb) | Perchlorate (ppb) | Moisture % |
|--|-----------|-----------|-------------------|------------|
| BD040104 | 120U | 120U | 9.5J | 1 |
| CD040104 | 120U | 120U | 5U | 0 |
| Day 3 | | | | |
| BD04020 | 120U | 120U | 5U | 0 |
| CD040204 | 120U | 120U | 5U | 0 |
| HMX= octahydro-1,3,5,7-tetranitro-1,3,5,7-tetrazocine RDX = hexahydro-1,3,5-trinitro-1,3,5-triazine | | | | |
| U = non-detect result J = estimated result | | | | |

A total of 20 post treatment samples were collected during the POP test. Nineteen of the twenty treated sample results indicate that perchlorate was treated to below the Method 314.1 detection level of 4 ppb. This level of success (95%) indicated that the treatment system and operational parameters were effective in meeting the soil remediation goal.

The baghouse and cyclone samples were below the treatment goals of 120 ppb for explosives on all three days of the POP. As listed in the tables, the perchlorate results were inconsistent for the soil samples from the cyclone and baghouse streams.

During the shakedown and spike testing period, interferences in the analytical method used for soil samples were discovered. Based on the fact that interferences were persistent during the analysis of the feed and treated soils using EPA Method 314.0, the project team proposed using an alternate Liquid Chromatography Tandem Mass Spectrometry (LC/MS/MS) method (EPA Method SW846/8321), which is more applicable to a soil matrix as opposed to the Method 314.0 which is more applicable to water samples. A series of samples were analyzed using both methods; the results indicated that false positives were sometimes detected using Method 314.0. The analytical change from EPA Method 314.0 to EPA Method SW846/8321 was approved by the regulatory agencies prior to implementation.

5. FULL SCALE OPERATIONS

Based on the results from the POP test, the following treatment parameters were established to meet the performance goals:

- Soil treatment temperature: 839°F, minimum
- Soil feed rate: approximately 40 tph, maximum
- STU discharge temperature: 1489°F, minimum.

At the start of full-scale operations, an unforeseen problem was encountered with the treatment process. Of the initial twenty 500 cy piles that were treated, only fourteen met the treatment standards (30% failure rate). The treatment failures were all for residual perchlorate contamination with concentrations ranging from 7 to 22 ppb. A review of the TTU process was conducted using data from the performance tests, as shown in Figures 4 and 5. Attempts were made to correlate the soil temperature and the feed rate to the failure of the treatment system. However, as can be seen in two representative charts from two spiking rounds, no direct correlation could be observed between the failure rate and the operating parameters viewed at the time of sample collection. A review of the sampling and laboratory analysis was also conducted to determine the cause and to reduce the frequency of treatment failures. No apparent causes for the treatment failures were identified in the analytical process, particularly since switching over to EPA Method 8321 seemed to have reduced interference that were previously observed.

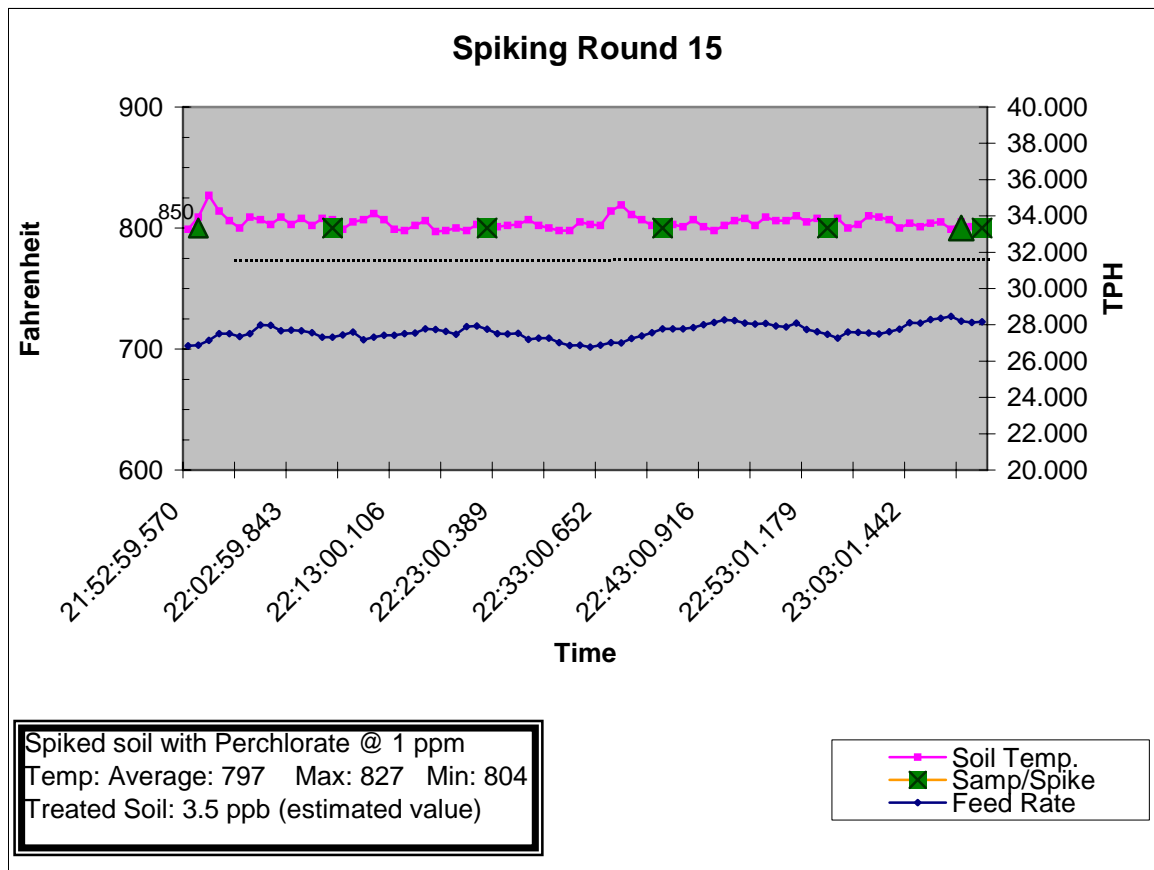

Figure 4. Operating Parameters during performance testing – Spike Test 15

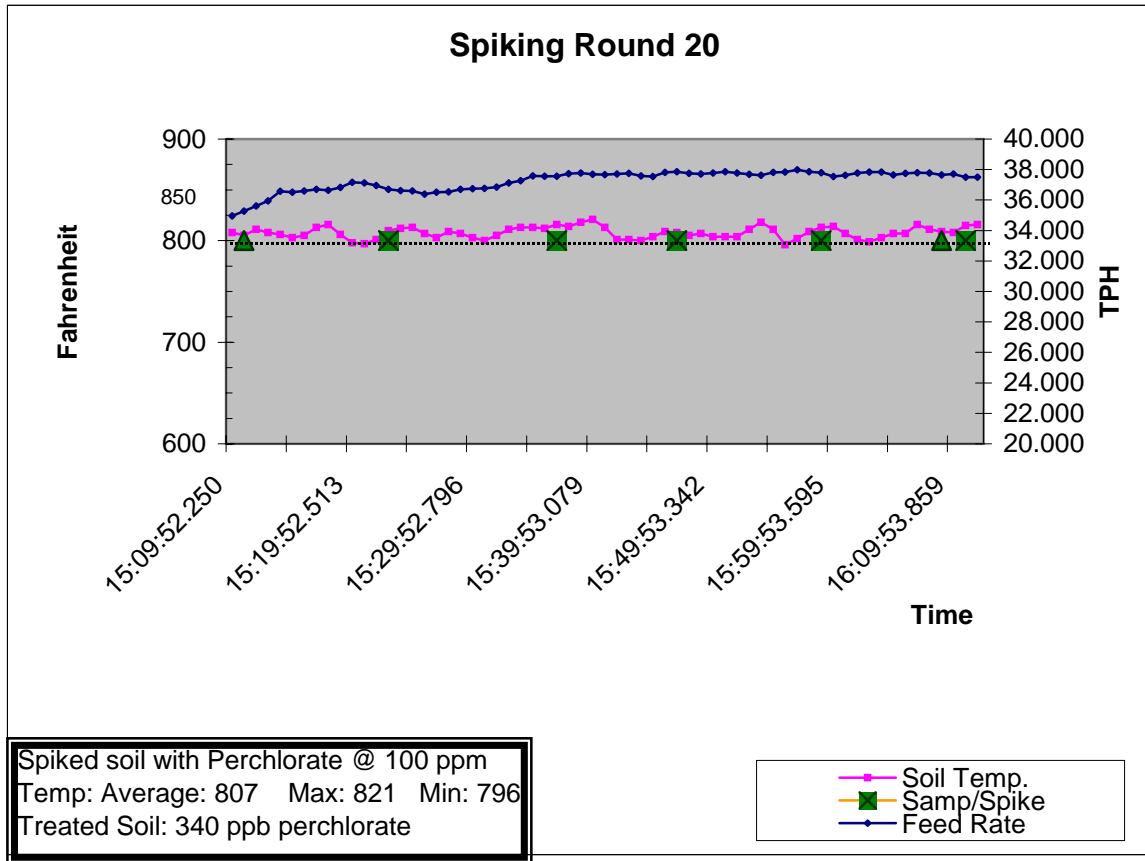

Figure 5. Operating Parameters during performance testing – Spike Test 20

Other factors that were examined were methods used for keeping the soil material dry. Typically, the soil was mixed with lime and this had been suspected to be interfering in the analytical method earlier; however, levels of lime mixed during initial full-scale operations were low and its usage did not correlate with the treatment failures.

The levels of perchlorate in the treated stockpiles seemed to be attributable to fines that were collected in the cyclone and mixed in the pugmill with the treated soil. It was noted that analytical results from the baghouse and cyclone samples steadily showed detects of perchlorate throughout the treatment process. Although these detects were less than the treatment goals of 4 ppb, it was feasible that a fraction of feed soil, in the form of fine particles suspended in the exhaust gas, was traveling through the system at a much higher rate than the average residence time for treated soil. These fines are captured in the cyclone; a portion is gravity fed into the pugmill while the remainder is carried over to the rest of the APC. These fine particulates could potentially have been part of any sample collected to measure the effectiveness of the treatment process.

Based on literature and previous testing results, the fine particles that were carried over to the thermal oxidizer would have been effectively treated based on the operating temperature. However, trace levels of particulates were also seen in the samples from the baghouse. These were surmised to be originating from either the relic concentration of previous high concentration spiking tests, or from particulates, which were carried over with the steam that is vented from the pugmill to the baghouse.

The following steps were taken to eliminate the failures.

- The treatment temperature was increased to 950 °F.
- The baghouse was thoroughly decontaminated and the recovered fines were blended into the feed stockpile

- The feed rate was temporarily lowered to 30 tph then later adjusted upwards to the maximum permissible 40 tph
- An attempt was made to operate the TTU by closing the discharge valve from the cyclone to the pug mill. However, the amount of particulate loading was beyond the design capacity of the baghouse making this procedure not feasible for continuous operation of the TTU.

The above steps did not consistently produce the desired results. Within the project constraints, it was not feasible to stop operations in order to re-design the system. Thus, a practical operational change was made in order to overcome this issue with the treatment process.

The treated soil stockpile area was initially configured to manage soils in batches of 500 cy piles, which corresponded to the sampling frequency for explosives. The sampling frequency of treated soils for perchlorate was increased through regulatory concerns to one every 100 cy. If any of the five samples representing the treated soil stockpile was above the treatment standard, the entire 500 cy pile was retreated through the TTU. The treated soil stockpile area was reconfigured so that the treated soil could be managed in 100 cy stockpiles. This is illustrated in Figures 6 and 7. Reconfiguring the stockpile area drastically reduced the percentage of soil stockpiles that showed an occasional failure due to particulate carryover. This also mitigated the consequence of a treated soil failure by greatly reducing the quantity of soil requiring re-treatment. During subsequent full-scale operation, two daily composite samples were collected from the material transferred from the baghouse to the pugmill and from the cyclone dust effluent, respectively. These samples were analyzed for perchlorate. Only one out of 85 bag house samples was above the remediation goal of 4.0 ppb and 12 out of 85 cyclone samples were above 4.0 ppb. These typically were on occasions were the treated soil samples also failed to meet the treatment criteria, further validating the source of the failure.



Figure 6. Site Infra-structure designed for 500 cy piles



Figure 7. Site Infra-structure re-designed for 100 cy piles

In summary, a total of 60,036 tons were processed and 55,123 tons were successfully treated during full-scale operations. The failure rate for perchlorate during full-scale operations was 8.9%. As described previously, only fourteen of the initial twenty 500 cubic yard piles met the treatment standards (30% failure rate). After the treated storage area was reconfigured to accommodate the separation of 100 cy piles and the process was optimized, the failure rate dropped to 1.33%. The majority of soil on the project was processed at this lower failure rate.

The TTU successfully treated 100% of explosives throughout the project with no detectable concentrations in the treated soil.

As previously discussed, operating data imply that low levels of perchlorate in the baghouse and cyclone streams are likely due to short-circuiting within the process so that small portions of contaminated soil are not exposed to the treatment temperature for the necessary amount of time. Recycling these fines back through the process was discussed but determined to be impractical under the existing systems configuration.

6. OBSERVATIONS FOR FUTURE DESIGN

This project was the first documented project in the country to thermally treat perchlorate contaminated soils, utilizing thermal destruction of an inorganic non-volatile contaminant as opposed to vaporization of organics for subsequent treatment by additional process units. Previous projects had demonstrated the successful applications of thermal desorption to treat explosive contaminated soil and this project had the same success. This project demonstrated that the same technology can be adapted to remove perchlorate from contaminated soil. It should be noted that factors such as feed characteristics, drying practices, pre-heating durations and residence time are important site specific

criteria that influence successful treatment, and should be re-assessed in the design phase for future projects.

Perchlorate-contaminated soils seemed to occasionally bypassed the primary treatment process and entered the air pollution control equipment. This resulted in occasional low-level detections of perchlorate in the treated soil. Future TTU designs intended for treatment of perchlorate to low treatment goals, as used during this project, could try to account for this by recycling dust to the beginning of the treatment train instead of the treated soil discharge. Conceptually, recycling the dust to the soil feed may help to reduce the frequency of failures in future systems, however that was not feasible with the equipment that was on-site for this project. Furthermore, based on the low failure rate, it may be more efficient to re-treat the failed soil as was done for this project.

Observations from analytical results indicated that LC/MS/MS method (Method 8321) is a performance-based method that provides definitive, reliable results confirmed by MS, especially at low levels. The method number has been subsequently changed to EPA SW846/Method 331. This method is less susceptible than method 314.0 to matrix interferences, such as those experienced in the treated soils during and prior to the performance test. Use of this method will assure that the treatment goal of 4 µg/kg can be confidently assessed for all samples. It is recommended that future project designs incorporate this particular method for analysis of solid matrices.

Lime, used as a soil amendment for drying, also seemed to cause interference in the analytical methods. Thus, alternate approaches to keeping the feed soil dry should be considered in future projects.

REFERENCES

- Bircumshaw, L.L., and Newman, B.H., 1954, "The Thermal Decomposition of Ammonium Perchlorate I. Introduction, experimental, analysis of gaseous products, and thermal decomposition experiments", *Proceedings of the Royal Society of London*, A227, 115-132.
- Guillory, W. A., and King, M., 1970, "Thermal Decomposition of Ammonium Perchlorate", *AIAA Journal*, vol. 8, no. 6, 1134-1136.
- Keenan, Arthur G., and Siegmund, Robert F., 1969, "Thermal Decomposition of Ammonium Perchlorate", *Quarterly Reviews, Chemical Society*, vol. 23(3), 430-452.
- P.W.M. Jacobs; H.M. Whitehead, 1969, "Decomposition and Combustion of Ammonium Perchlorate", *Chemical Reviews*, vol. 69, 551-590.
- Manelis, G. B., et al, 2003, Thermal Decomposition and Combustion of Explosives and Propellant, Chapter 13, *Ammonium Perchlorate*, 189-220, Taylor and Frances, ISBN# 0415299845.
- ECC, 2004. Thermal Treatability Study Report for Impact Area Groundwater Study Program, Massachusetts Military Reservation, Camp Edwards, MA. January 27, 2004.
- ECC 2004. Proof of Performance Test Report for Impact Area Groundwater Study Program, Massachusetts Military Reservation, Camp Edwards, MA. August 9, 2004.
- ECC 2006. TTU Completion Report for Impact Area Groundwater Study Program, Massachusetts Military Reservation, Camp Edwards, MA. February 10, 2006.
- MADEP (Massachusetts Department of Environmental Protection) 2004 "Revised Conditional Approval" of Comprehensive Plan Application No. 4P03015.

Chapter 17

PERCHLORATE REDUCTION IN A PACKED BED BIOREACTOR USING ELEMENTAL SULFUR

Ashish K Sahu and Sarina J Ergas

Department of Civil and Environmental Engineering, University of Massachusetts, Amherst, MA 01003

Abstract: This study investigated perchlorate reduction by sulfur utilizing perchlorate reducing bacteria (SUPeRB). SUPeRB cultures were enriched from a denitrifying wastewater inoculum in medium containing elemental sulfur (S^0), crushed oyster shell, nutrients and perchlorate. Perchlorate was reduced from 5 to < 0.5 mg/L in approximately 15 days. The enrichment culture was subsequently inoculated into a continuous flow packed-bed bioreactor containing S^0 and crushed oyster shell medium. High-level perchlorate concentrations (5-8 mg/L) were reduced to < 0.5 mg/L with an empty bed contact time (EBCT) of 13 hours. Low levels of perchlorate concentrations (80-120 $\mu\text{g/L}$) were treated varying two parameters, recirculation ratio and empty bed contact time (EBCT). Little or no recirculation was required to efficiently reduce perchlorate to < 4 $\mu\text{g/L}$. The system also proved somewhat independent of EBCT. Investigations of the effect of nitrate on perchlorate removal and reactor media particle size is on going and will be presented at the meeting.

1. INTRODUCTION

Perchlorate (ClO_4^-) contamination has primarily occurred in association with manufacturing of missiles, fireworks, and other industrial processes (Urbansky, 2000) and has been recorded in 38 US states (MADEP, 2005). Military applications have also resulted in contaminants such as nitrate and Royal Dutch Explosives (RDX) present with perchlorate as co-contaminants. (Clausen *et al.*, 2004). Perchlorate contamination poses a significant health threat, and toxicological studies have demonstrated that it interferes with iodine uptake into the thyroid gland disrupting thyroid function (O'Connor and Coates, 2002). Although national standards have yet to be established, the Commonwealth of Massachusetts has set a maximum contaminant limit for perchlorate of 2 $\mu\text{g/L}$.

Perchlorate is highly soluble and stable in water and hence cannot be removed by conventional drinking water treatment processes such as filtration or air stripping (Tipton *et al.*, 2003). As an alternative, biological reduction of perchlorate has been investigated by several researchers and is thought to be the most cost-effective process for perchlorate removal (Min *et al.*, 2004). Certain bacteria have shown to metabolize perchlorate to chloride, which is harmless to the environment. Several electron donors (acetate, wastewater, hydrogen, elemental iron, thiosulfate), have been previously investigated for perchlorate reduction using pure and mixed cultures (Urbansky, 2000). Use of S^0 as an electron donor for autotrophic perchlorate reduction has been previously attempted but was not successful (Bardiya and Bae, 2005).

This study investigated sulfur utilizing perchlorate reducing bacteria (SUPeRB) for perchlorate reduction. Sulfur-oxidizing bacteria have been proven to successfully convert nitrate to nitrogen (denitrification) in water and wastewater treatment applications (Sengupta *et al.*, 2006). Since the thermodynamic values of energy gained by microorganisms from nitrate and perchlorate are close to each other (Nerenberg *et al.*, 2002) an attempt was made to investigate perchlorate reduction using the same microbial consortium with S^0 as the main electron donor. Elemental sulfur pellets have many advantages as a bioreactor packing material, namely they are inexpensive and readily available as a

waste by-product of petroleum industry. Also, since sulfur-oxidizing bacteria are autotrophs they grow slowly, producing very little sludge hence, reducing the maintenance required for backwashing.

2. RESEARCH OBJECTIVES

The overall objective of this research was to engineer a robust, reliable and inexpensive biological process for treatment of perchlorate contaminated water, using S^0 as an electron donor with SUPeRB cultures. The specific objectives were to:

1. Investigate the effects of operating parameters (perchlorate concentration, particle size, EBCT and recirculation rates) on perchlorate removal in packed bed bioreactors.
2. Test the removal efficiencies of perchlorate in the presence of nitrate as a groundwater co-contaminant.

3. MATERIALS AND METHODS

3.1 Batch Culture Enrichments

SUPeRB was enriched from mixed liquor suspended solids (MLSS) from the denitrification stage of the Berkshire mall wastewater treatment facility (Lanesboro, MA), which utilizes methanol as an electron donor. Batch cultures were set up in 1000 mL Erlenmeyer flasks containing sulfur pellets (30 g), crushed oyster shell as an alkalinity source (10 g), 250 mL MLSS, and 250 mL of synthetic perchlorate contaminated groundwater. The cultures were incubated with agitation at 150 rpm in the dark at 20°C. Groundwater (Amherst, MA) was used to prepare synthetic groundwater medium containing 5 mg/L ClO_4^- , 0.5 g/L $NaHCO_3$, 8.5 mg/L KH_2PO_4 , 21.75 mg/L K_2HPO_4 , 33.4 mg/L $Na_2HPO_4 \cdot 7H_2O$, 22.5 mg/L $MgSO_4 \cdot 7H_2O$, 0.25 mg/L $FeCl_3 \cdot 6H_2O$ and 27.5 mg/L $CaCl_2$. N_2 gas was periodically sparged through the cultures to maintain anaerobic conditions. The cultures were monitored for perchlorate concentration over time.

3.2 Bioreactor

A bench scale bioreactor (working volume one-liter) was constructed from acrylic glass tubing with an inner diameter of 6.1 cm and a 34 cm in height. Four sample ports, evenly distributed along the height of the reactor, were sealed with septum ports for obtaining profiles of perchlorate vs. depth. Recirculation from the effluent to the influent was provided using a variable speed peristaltic pump. The reactor was packed with 4 mm sulfur pellets (Georgia Gulf Sulfur Corp., Valdosta, GA) as the electron donor and crushed oyster shell as an alkalinity source (3:1 by volume). To test the effect of small sulfur size particles, elemental sulfur and oyster shell were crushed and sieved to 0.85 mm (ASTM date???) and were used as a packing material in one of the bioreactors.

3.3 Experimental Program

Four packed bed bioreactors were packed with sulfur/oyster shell media, inoculated with SUPeRB enriched from batch cultures and operated in an upflow mode. Table 1 shows the experimental program used to investigate the following bioreactor operating parameters: perchlorate concentration, recirculation rate, EBCT, particle size and the presence of nitrate as a co-contaminant. During the Phase I experiments, the synthetic groundwater used to feed the bioreactor was the same as was used in the enrichment studies (above). During Phase II, the synthetic groundwater was diluted with additional groundwater to achieve the target concentration of 0.08-0.12 mg/L.

Table 1. Experimental program for operation of packed bed reactors

| Experimental Phase | Perchlorate concentration mg/L | EBCT hrs | Recirculation ratio | S ⁰ particle size |
|--------------------|--|----------|--------------------------|------------------------------|
| Phase I | 5-8 | 13-100 | Intermittent at 37-1,580 | 4 mm |
| Phase II | | | | |
| Reactor 1 | 0.08-0.12 | 25-30 | 52, 1,016 | 4 mm |
| Reactor 2 | 0.08-0.12 (NO ₃ -N 10 mg/L) | 8-30 | None | 4 mm |
| Reactor 3 | 0.08-0.12 | 8-30 | None | 0.85 mm |

3.4 Perchlorate Analysis

Samples were prepared for perchlorate analysis by filtering through 47 mm Millipore glass fiber filter. Perchlorate was analyzed using USEPA Method 314.0 (USEPA, 1999). For Phase I experiments, high level perchlorate concentrations were measured using a DX-500 Ion Chromatograph (IC) system (Dionex, Sunnyville, CA) equipped with an Ionpac AS16 column, an AG16A guard column, and a CD20 conductivity detector. The eluent used was 35 mM NaOH at 1 mL/min. The detection limit was 0.5 mg/L. For Phase II experiments, low level perchlorate concentrations (0.5-50 µg/L) were measured using the same IC with a 1000 µL injection loop. Samples were manually filtered through onguard silver (Ag) and barium (Ba) cartridges to remove chloride and sulfate. The reporting limit was 4 µg/L. Nitrate was measured using the same IC but with Ionpac AS14 column, AG14A guard column. The eluent was 8.0 mM Na₂CO₃/1.0 mM NaHCO₃ at 1 mL/min. The lowest reporting limit was 0.01 mg/L NO₃⁻-N. The pH-values were measured using an Orion 720A pH meter.

4. RESULTS AND DISCUSSION

4.1 Batch Cultures

The reduction of perchlorate by SUPeRB using S⁰ in batch culture from an initial concentration of 4.5 mg/L a final concentration of 0.5 mg/L was achieved within the first 15 days (Figure 1). The flask was then spiked with perchlorate to the original concentration and sparged with N₂ to maintain anaerobic conditions. This procedure was repeated each time perchlorate concentration was reduced to below 0.5 mg/L. The data indicate that perchlorate can be biologically reduced by denitrifying cultures using S⁰ as an electron donor. These results are comparable to those observed for nitrate reduction (Lopez-Luna *et al.*, 2005).

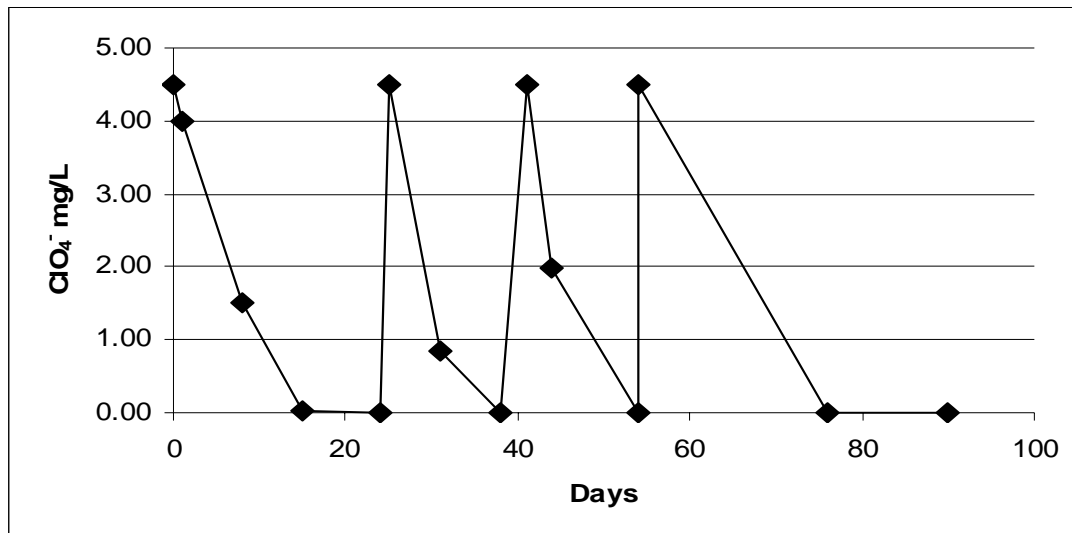

Figure 1. Perchlorate enrichment culture using sulfur as an electron donor

4.1.1 Phase I: Bioreactor Performance at High Perchlorate Concentrations

The packed bed bioreactor was inoculated with SUPeRB from the batch cultures and initially operated with a 100 hour EBCT and an influent perchlorate concentration of 5 mg/L (high perchlorate). An acclimation period of approximately 26 days was observed after which a steady effluent perchlorate concentration was observed. Average removal efficiencies for the high perchlorate concentration experiments at varying EBCTs with and without recirculation are given in Table 2. Intermittent recirculation was employed on selected days to promote mass transfer of perchlorate to the biofilm; however, the effect of recirculation on perchlorate removal during this phase was inconclusive. On day 259, the influent perchlorate concentration was raised to ~8 mg/L to challenge the system with higher perchlorate concentrations. The spike had no significant effect on effluent concentration, which resulted in a 96% perchlorate removal efficiency.

Table 2. Packed bed reactor performance at high perchlorate concentrations

| Days of Operation | Empty bed contact time in hrs | Recirculation velocity at 9.7 cm/min | Average removal efficiency |
|-------------------|-------------------------------|--------------------------------------|----------------------------|
| 1-30 | 100 | No | 66 % |
| 31-43 | 100 | Yes | 61 % |
| 44-57 | 100 | No | 90 % |
| 58-62 | 61 | Yes | 99 % |
| 63-68 | 61 | No | 58 % |
| 69-129 | 61 | Yes | 96 % |
| 130-132 | 36 | Yes | 99 % |
| 133-175 | 36 | No | 93 % |
| 176-198 | 16 | No | 80 % |
| 199-210 | 13 | Yes | 92 % |
| 211-258 | 13 | No | 81 % |
| 259-268* | 13 | No | 90 % |
| 269-280* | 13 | Yes | 90 % |

*indicates higher influent concentration of perchlorate (~ 8 mg/L)

4.1.2 Phase II: Bioreactor performance at low concentration

After conducting the high perchlorate concentration experiments, the contents of the packed bed reactor, including biomass, were divided and mixed with fresh sulfur/oyster shell media to construct two new packed bed reactors (Reactor 1 and Reactor 2). Both reactors were operated at low perchlorate concentrations (80-120 µg/L), more typical of contaminant groundwater levels. Reactor 1

was operated at a constant EBCT of 30 hrs and varying recirculation ratios while Reactor 2 was operated with no recirculation and varying EBCT. Figure 2 shows the effect of recirculation ratio on treatment of low perchlorate concentrations at an EBCT of 30 hrs. Decreased removal efficiencies were observed at increased recirculation ratios. Perchlorate reducing bacteria are slow growing autotrophs and the loss of biofilm from the sulfur pellets under turbulent conditions may have resulted in lower perchlorate removal efficiencies at higher recirculation ratios. The highest removal efficiency (92%) was observed at the lowest recirculation ratio ($Q_r/Q=52$), however due to pump limitations further reductions in recirculation ratios were not investigated.

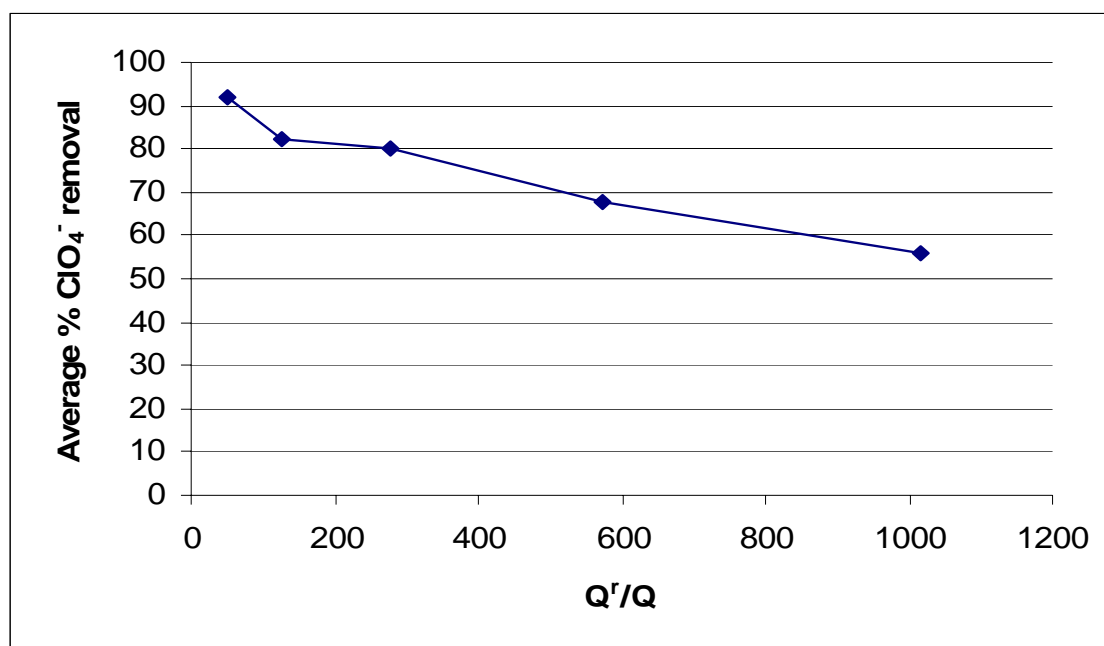

Figure 2. Effect of recirculation velocity on low level perchlorate removal. Q_r is the recirculation flow rate and Q is the influent flowrate

Reactor 2 was used to investigate low level perchlorate removal at varying EBCT without recirculation (Figure 3). After observation of steady perchlorate removal efficiency at an EBCT of 30 hours, the EBCT was reduced in steps to a final value 8 hours. Average perchlorate removal efficiencies at EBCTs of 30, 15, 12 and 8 hours were 75%, 90%, 87% and 96%, respectively, showing that removal efficiency was independent of EBCT within this range but in general showed steady improvement over time of operation of the reactor. By the end of 130 days, consistent effluent perchlorate concentrations below a MDL of 4 $\mu\text{g/L}$ were achieved at influent perchlorate concentrations of 80-120 $\mu\text{g/L}$ and an EBCT of 8 hours. The bioreactor was then operated with 100 $\mu\text{g/L}$ perchlorate and 10 mg/L NO_3^- -N. The experiments are on going and will be presented at the meeting.

Reactor 3 was started with SUPeRB from enriched batch cultures, 0.85 mm sulfur and oyster shell packing and an initial EBCT of 22 hours. An influent perchlorate concentration of 0.08-0.1 mg/L was maintained. An average perchlorate removal of 63% was observed in this reactor over an operating period of 54 days. Stepwise reduction of EBCT is presently underway and the results will be presented at the meeting.

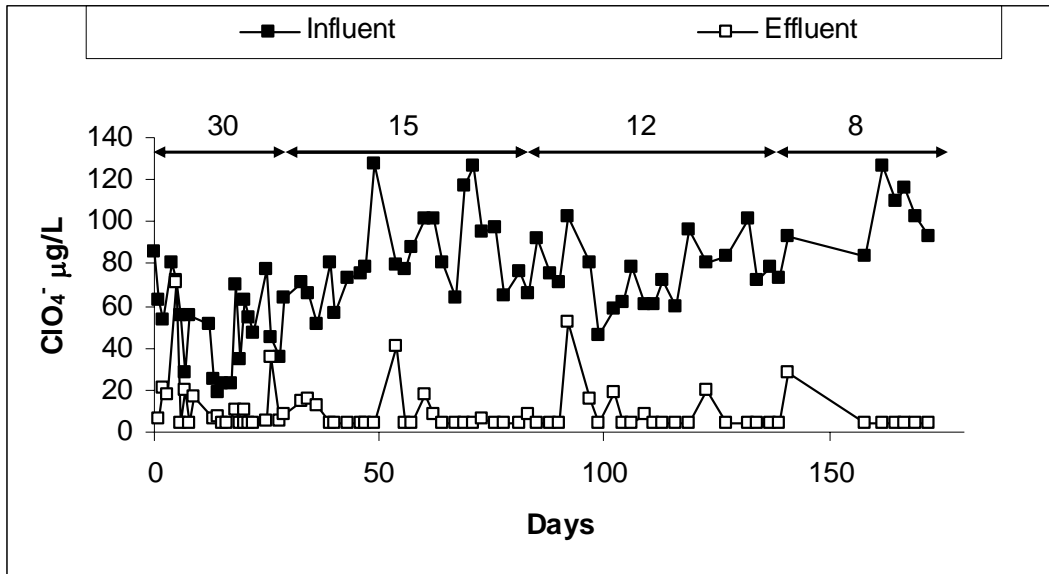

Figure 3. Performance of packed bed reactor with no recirculation and varying EBCTs (EBCT values shown above the arrows)

Perchlorate concentration profiles over the length of the column are shown for Reactors 2 at two EBCTs in Figure 4. Active perchlorate degradation was observed in the first 10 cm of Reactor 2, suggesting that most bacteria resided and formed biofilms where the electron acceptor was readily available and that there was little change in the concentration profile when the EBCT was decreased. The column profile for a 22 hr EBCT in Reactor 3 (Figure 4) shows that perchlorate was reduced from 84 $\mu\text{g/L}$ to 13 $\mu\text{g/L}$ over the entire length of the column. This profile was taken only a few days after the start of the experiment, suggesting that in the early stages of biofilm growth the entire reactor is utilized for perchlorate reduction.

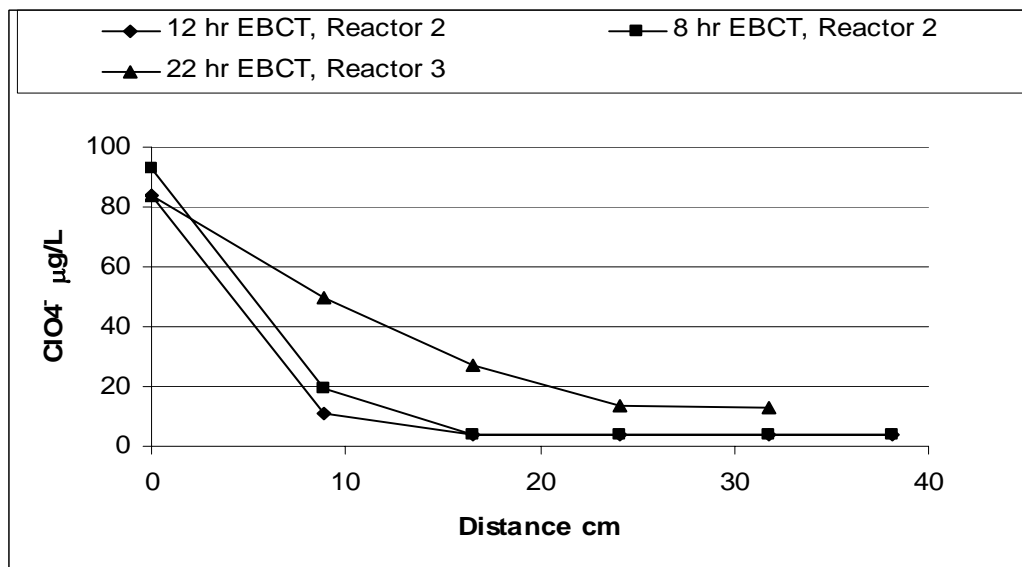

Figure 4. Column profile of packed bed reactor operated at low (0.08-0.1 mg/L) perchlorate concentration for reactors 2 (4 mm) and 3 (0.85 mm)

5. CONCLUSIONS

This research investigated a novel biological process for treatment of perchlorate contaminated water using S^0 as an electron donor and the microbial community carrying out the perchlorate degradation. A culture enriched from sludge from the denitrifying section of a wastewater treatment plant with S^0 and oyster shell media was able to reduce perchlorate from 5 mg/L to less than 0.5 mg/L in approximately 15 days. SUPeRB cultures were subsequently inoculated into bench-scale upflow packed bed bioreactors filled with elemental sulfur and oyster shell. High levels of perchlorate (5-8 mg/L) were successfully reduced to less than 0.5 mg/L in the bioreactor at an EBCT of 13 hours. Low levels of perchlorate (80-120 μ g/L) were reduced to less than 4 μ g/L at an EBCT of 8 hours. Increased recirculation ratios resulted in decreased perchlorate removal efficiency, possibly because of removal of microbial biomass from the packing media.

REFERENCES

- Bardiya, N. and Bae, J.H. 2005. Bioremediation potential of a perchlorate -enriched sewage sludge consortium. *Chemosphere* 58:p. 83-90.
- Clausen, J., Robb, J., Curry, D. and Korte, N. 2004. A case study of contaminants on military ranges: Camp Edwards, Massachusetts, USA. *Environmental Pollution.*, 129:13-21
- Lopez-Luna, E.L., Ergas, S.J. and Sengupta, S. 2005. Autotrophic sulfur oxidizing denitrification for total nitrogen removal in on site wastewater treatment systems, *Proceedings at the 78th Ann. Meet. Water Environ. Fed.*, Washington, DC.
- MADEP. 2005. *The Occurrence and Sources of Perchlorate in Massachusetts* Draft report 310 CMR 15.000, URL: <http://www.mass.gov/dep/water/wastewater/altpercf.htm>.
- Min, B., Evans, P.J., Chu, A.K. and Logan, B.E. 2004 Perchlorate removal in sand and plastic media bioreactors. *Water Research*, 38:p. 47-60
- Nerenberg, R., Rittmann, B.E., and Najm, I. 2002. Perchlorate reduction in a hydrogen based membrane biofilm reactor. *Journal AWWA.*, 94(11): 103-114.
- O'Connor, S.M. and J.D. Coates. 2002. Universal Immunoprobe for (Per)Chlorate-Reducing Bacteria. *Appl. Environ. Microbiol.*, 68: p. 3108-3113
- Sengupta, S., Ergas, S.J., Lopez-Luna, E., Wood, J., Sahu, A.K., Palaniswamy, K. 2006. Autotrophic biological denitrification for complete removal of nitrogen from septic system wastewater, *J. Water, Air, Soil Pollution*, 6(1-2): 111-126.
- Tipton, D.K., Rolston, D.E. and Scow, K.M. 2003. Bioremediation and Biodegradation - Transport and Biodegradation of Perchlorate in Soils. *J. Environ. Qual.*, 32: p. 40-46
- United States Environmental Protection Agency (USEPA) 1999. Method 314.0: Determination of perchlorate in drinking water using ion chromatography.
- Urbansky, E.T. 2000. *Perchlorate in the Environment*, Kluwer Academic/Plenum Publishers, New York, NY.

PART VIII: Radionuclides

Chapter 18

RADIOACTIVE SOIL CHARACTERIZATION OF THE STATE OF SAO PAULO, BRAZIL

Goro Hiromoto¹, Ana Claudia Peres¹, Maria Helena Tadei², Marcio Roberto Soares³ and Luis Reynaldo Ferraciu Alleoni⁴

¹*Instituto de Pesquisas Energeticas e Nucleares, Av. Prof. Lineu Prestes 2242, Sao Paulo, SP, CEP 05508-000, Brasil;* ²*Comissao Nacional de Energia Nuclear, Laboratorio de Poços de Caldas, Rod. Andrade-Poços de Caldas km 13, Poços de Caldas, MG, CEP 37701-970, Brasil;* ³*Universidade Federal de Sao Carlos, Centro de Ciencias Agrarias, Rod. Anhanguera km174, Araras, SP, CEP 13600-970, Brasil;* ⁴*Universidade de São Paulo/Escola Superior de Agricultura Luiz de Queiroz, Av. Pádua Dias, 11, Piracicaba, SP, CEP 13418-900, Brasil*

Abstract: For proper management of soil and groundwater quality, background levels of toxic elements in a given ecosystem must be known. The aim of this study is to determine quality reference values for radioactive content in representative soils from the São Paulo State, Brazil.

Thirty samples were collected and the concentration of U-nat, Th-nat, 228Ra, 226Ra, 210Pb, 137Cs and 40K were evaluated and correlated with soil mineralogical characteristics. The types of soil and sampling places were chosen according to their representativeness and spatial distribution in the State geological formations, taking also into account their nearness to large urban areas. The samples were measured by means of passive gamma spectrometry and sequential chemical extraction, followed by alpha spectrometry. Results showed a wide variation on background levels for natural radionuclides of the uranium and thorium series and very low concentration of 137Cs from radioactive fallout.

Key words: Soil; radioactivity; background levels; characterization contamination.

1. INTRODUCTION

Over the last decades, as a result of past agricultural and industrial activities lacking adequate regulatory control, contaminated areas have become a great environmental issue.

In search for proper solutions to these questions, soil remediation policies have been implemented in several countries (Kolluru et al, 1996). In general, soil remediation is an expensive option. Besides which, typically the elapsed time between the identification of the contaminated area and the decision to undertake corrective action is too great, due to the complexity of the site-specific studies necessary for a proper characterization of all the associated risks. Nevertheless, in face of this, governmental agencies from countries such as the Netherlands (VRON, 1988), the USA (U.S.EPA, 1966) and Germany (Bachmann, 2000), among others, have opted to establish target values for soil quality as a first step in the whole process of risk assessment.

In Brazil, the only state to adopt target values for soil contamination – specific to its characteristics – is the State of São Paulo, through its governmental agency for pollution control - CETESB. Three levels have been established: (1) quality reference value, indicating the quality level of a soil considered as clean soil, generally associated with the natural concentration of the element of interest; (2) preventing value, above which harmful changes in the soil quality may occur; and (3) intervention value, above which potential risks to the human health exist, considering a generic exposure scenario (CETESB, 2005).

The list of the elements for which target values are in force includes organic chemicals, volatile organic compounds and heavy metals, all of them potential carcinogens and, therefore, subject to regulatory control. However, it does not include radionuclides. In addition, Brazilian National Nuclear Energy Commission (CNEN), the federal agency responsible for regulating nuclear activities in the country, has not established target values for radioactive soil contamination either.

The main aim of the present study is to perform a radioactive characterization of representative soils from the São Paulo State, in order to determine background levels for some selected radionuclides, which could be used as a quality reference value.

2. MATERIALS AND METHODS

Surface samples (0-0.2 m depth) of 30 profiles of non-cultivated soils were collected in areas of native vegetation or ancient reforestation in the State of Sao Paulo, Brazil. This state has mainly four kinds of climate (Köppen) according to the slope: tropical wet and dry (Aw), in the shore coastline (20-22°C; 4,154 mm/yr); humid subtropical (Cwa), in the plateau (20°C; 1,300 mm/yr); tropical wet and dry (As), in the northwest region (24°C; 1,000-1,250 mm/yr); and humid subtropical (Cfa), in the south region (18-20°C; 1,500 mm/yr). The remaining natural vegetation is composed by Atlantic Rain forest along the shore and surrounding the plateau. The rest of these areas present fragments of semideciduos forest and a kind of vegetation that includes all the formations of the Cerrado biome, such as clean grass fields, grassland with some shrubs and the cerrado strictu sensu (short savannah), that is arbustive and herbaceous, and the forest formation of “cerradão” (closed savanna approaching a forest). Oxisols, Ultisols, Alfisols, Entisols, Inceptisols, Histosols and Mollisols were found in these regions constituting a group with wide variation on (electro)chemical, physical and mineralogical properties.

Soil types and sampling places were chosen according to their representativeness and spatial distribution in the State geological formations, taking also into account their nearness to large urban areas. Thirty samples were collected in areas presenting low anthropic perturbation - native vegetation or ancient reforestation -, minimizing the chances that selected areas could have sustained anthropic effects in recent past.

Samples were collected using steel stainless instruments, in accordance to the standard procedures recommended by CETESB (CETESB, 2001); they were conditioned in polyethylene bags for transportation and dispersed over benches for natural drying. After that, the soils were sieved to less than 2,0 mm granular size. The granulometric analysis of soil samples followed the densimetry method, after dispersion with $(\text{NaPO}_3)_6 \cdot \text{Na}_2\text{O}$ (0.015 mol L^{-1}) + NaOH (1 mol L^{-1}) (Soares, 2004). Table 1 presents the soil type and the content of clay, silt and sand.

Contents of ^{228}Th , ^{228}Ra , ^{226}Rn , ^{210}Pb , ^{137}Cs and ^{40}K were determined by means of passive gamma spectrometry using a hyperpure germanium detector, in a 100 mL polyethylene flask, for a counting time ranging from 90.000 to 220.000 seconds. The flasks were previously sealed to assure that radioactive equilibrium between ^{226}Ra , as well ^{228}Th , and their short-living daughters would be reached.

Contents of U-nat and Th-nat were determined by means of spectrophotometry, employing Arsenazo III.

Table 1. Types of the soils collected in the São Paulo State and contents of clay, silt and sand.

| Soil Type ¹ | Geographical Coordinates | Composition (%) | | |
|-----------------------------|--------------------------|-----------------|-------|------|
| | | Clay | Silte | Sand |
| 1 – Typic Hapludox | 22°19'S 47°10'W | 18.1 | 4 | 77.9 |
| 2 – Typic Hapludox | 22°15'S 47°49'W | 22.1 | 2 | 75.9 |
| 3 – Typic Hapludox | 22°19'S 47°10'W | 20.2 | 6 | 73.8 |
| 4 – Rhodic Eutrudox | 22°01'S 47°53'W | 20.1 | 8.1 | 71.8 |
| 5 – Rhodic Hapludox | 21°05'S 47°08'W | 53 | 10.2 | 36.8 |
| 6 – Rhodic Eutrudox | 22°43'S 47°38'W | 68.4 | 20.7 | 10.9 |
| 7 – Rhodic Acrudox | 21°10'S 47°48'W | 71.6 | 14.3 | 14.1 |
| 8 – Xanthic Hapludox | 22°15'S 47°49'W | 22.2 | 4 | 73.8 |
| 9 – Xanthic Hapludox | 21°57'S 47°59'W | 34.2 | 6 | 59.7 |
| 10 – Anionic Acrudox | 20°10'S 48°02'W | 47 | 12.3 | 40.7 |
| 11 – Arenic Hapludult | 22°32'S 47°54'W | 6 | 10 | 84 |
| 12 – Arenic Hapludult | 22°17'S 49°33'W | 10 | 32 | 58 |
| 13 – Arenic Hapludult | 22°38'S 47°11'W | 24.7 | 20.6 | 54.7 |
| 14 – Arenic Hapludalf | 22°59'S 47°30'W | 20.2 | 38.4 | 41.4 |
| 15 – Typic Hapludalf | 22°59'S 47°30'W | 36.6 | 44.8 | 18.6 |
| 16 – Arenic Hapludult | 22°43'S 47°38'W | 24.6 | 12.3 | 63 |
| 17 – Arenic Hapludalf | 22°12'S 49°56'W | 10 | 34.1 | 55.8 |
| 18 – Typic Hapludalf | 22°06'S 47°07'W | 42.7 | 42.7 | 14.6 |
| 19 – Typic Quartzipsamment | 22°32'S 47°54'W | 8 | 4 | 88 |
| 20 – Lithic Udortent | 22°12'S 49°39'W | 14.2 | 34.6 | 51.2 |
| 21 – Typic Usthorthent | 22°26'S 49°45'W | 10.1 | 30.2 | 59.7 |
| 22 – Typic Hapludult | 22°06'S 46°40'W | 34.5 | 18.2 | 47.3 |
| 23 – Kandiuudalfic Eutrudox | 21°10'S 47°48'W | 65.8 | 26.7 | 7.5 |
| 24 – Typic Haplaquox | 24°43'S 47°52'W | 53.2 | 28.7 | 18.1 |
| 25 – Typic Eutraquox | 22°43'S 47°38'W | 47.6 | 38 | 14.4 |
| 26 – Typic Medifibris | 24°43'S 47°52'W | 27.5 | 40.1 | 32.4 |
| 27 – Typic Dystrochep | 22°22'S 46°56'W | 24.3 | 10.1 | 65.6 |
| 28 – Arenic Albaquilt | 22°43'S 47°38'W | 20.4 | 34.7 | 44.9 |
| 29 – Arenic Hapludalf | 22°12'S 49°39'W | 4 | 24 | 72 |
| 30 – Typic Argiudoll | 22°07'S 47°39'W | 54.3 | 25.1 | 20.6 |

¹ Classification according to USDA Soil Taxonomy (Soil Survey Staff, 1999)

3. RESULTS AND DISCUSSION

Results of the radionuclide determination are presented in Table 2. A wide variation in activity concentration could be observed for all the elements analyzed, even for the same type of soil, except for the ¹³⁷Cs. The analysis of the statistical distribution of the given values revealed that that no clear choice between a log-normal or normal pattern can be made. This result was expected for the ¹³⁷Cs, since it is not an isotope naturally present in the soil and fallout precipitation is expected to be relatively uniform over the State area. The activity concentration values for the ¹³⁷Cs obtained are very close to the detection limits for most samples and normal pattern was adopted in this case; for other radionuclides, option was made for a log-normal distribution.

No significant correlation could be observed between the clay, silt and sand content in the samples and the respective activity concentration of the radionuclides.

Table 2. Activity concentration in soil of selected radionuclides (Bq per kg of dry soil)

| Soil | Radionuclide | | | | | | | |
|------|--------------|--------|-------------------|-------------------|-------------------|-------------------|-------------------|-----------------|
| | U-nat | Th-nat | ²²⁸ Th | ²²⁸ Ra | ²²⁶ Ra | ²¹⁰ Pb | ¹³⁷ Cs | ⁴⁰ K |
| 1 | <47 | 18 ± 3 | 14.6 ± 0.8 | 11.9 ± 1.9 | 8.6 ± 1.2 | 21 ± 3 | 1.9 ± 0.4 | 26.4 ± 8.5 |
| 2 | <47 | 32 ± 4 | 15.7 ± 0.8 | 16.1 ± 2.0 | 9.5 ± 1.2 | <20 | 1.2 ± 0.4 | 34.2 ± 8.6 |
| 3 | <47 | 12 ± 2 | 30.6 ± 0.9 | 27.2 ± 2.3 | 10.9 ± 1.2 | <20 | 1.3 ± 0.5 | < 11.1 |
| 4 | <47 | 12 ± 2 | 11.9 ± 0.7 | 9.1 ± 1.6 | 5.9 ± 0.9 | <20 | 0.8 ± 0.4 | 49.0 ± 7.3 |
| 5 | 124 ± 14 | 65 ± 8 | 94.4 ± 2.1 | 77.7 ± 4.9 | 56.2 ± 2.6 | 56 ± 6 | < 0.3 | 64.8 ± 18.9 |
| 6 | <47 | 33 ± 4 | 32.4 ± 1.8 | 22.5 ± 4.2 | 14.6 ± 2.4 | 60 ± 8 | 2.9 ± 0.7 | 15.3 ± 19.1 |

| | Radionuclide | | | | | | | |
|-------|--------------------|--------------------|---------------------|---------------------|---------------------|--------------------|-----------|---------------------|
| 7 | 57 ± 8 | 35 ± 5 | 32.7 ± 1.7 | 29.0 ± 4.0 | 13.3 ± 2.3 | 60 ± 7 | 2.0 ± 0.7 | 50.2 ± 18.3 |
| 8 | <48 | 15 ± 2 | 33.4 ± 0.8 | 28.1 ± 2.0 | 15.7 ± 1.1 | <20 | 1.8 ± 0.4 | 119.8 ± 8.8 |
| 9 | <47 | 33 ± 4 | 41.9 ± 1.5 | 34.9 ± 3.5 | 16.0 ± 1.9 | 26 ± 3 | <0.8 | 15.6 ± 15.0 |
| 10 | <47 | 43 ± 6 | 60.0 ± 1.1 | 54.6 ± 2.6 | 34.2 ± 1.4 | 35 ± 4 | 0.8 ± 0.5 | 51.1 ± 9.4 |
| 11 | <47 | <6 | 8.2 ± 1.1 | 9.3 ± 2.5 | 4.5 ± 1.4 | <20 | 1.2 ± 0.5 | 47.7 ± 12.1 |
| 12 | <47 | 18 ± 3 | 13.5 ± 1.1 | 12.7 ± 2.7 | 12.5 ± 1.6 | 25 ± 6 | 1.1 ± 0.5 | 104.8 ± 13.2 |
| 13 | 61 ± 8 | 76 ± 10 | 83.8 ± 1.1 | 70.3 ± 2.7 | 36.4 ± 1.2 | 32 ± 8 | 2.7 ± 0.4 | 54.1 ± 8.0 |
| 14 | <48 | 16 ± 2 | 19.2 ± 1.4 | 14.6 ± 3.2 | 18.7 ± 1.9 | 33 ± 8 | 1.3 ± 0.6 | 96.9 ± 15.5 |
| 15 | <47 | 41 ± 5 | 57.9 ± 1.8 | 52.8 ± 6.3 | 21.7 ± 2.3 | 35 ± 9 | 1.4 ± 0.7 | 344.8 ± 19.7 |
| 16 | 56 ± 8 | 61 ± 8 | 66.5 ± 0.9 | 56.8 ± 2.4 | 40.4 ± 1.2 | 70 ± 10 | 2.1 ± 0.4 | 111.3 ± 7.9 |
| 17 | <47 | 23 ± 3 | 25.9 ± 1.2 | 24.8 ± 2.8 | 13.1 ± 1.6 | 30 ± 7 | 2.2 ± 0.5 | 351.3 ± 15.0 |
| 18 | <48 | 63 ± 8 | 76.6 ± 1.8 | 61.0 ± 4.3 | 61.8 ± 2.5 | 64 ± 13 | 1.9 ± 0.7 | 38.3 ± 17.6 |
| 19 | <47 | 8 ± 2 | 4.8 ± 0.5 | 3.3 ± 1.1 | 1.0 ± 0.7 | <20 | 1.0 ± 0.3 | < 13.2 |
| 20 | <47 | 18 ± 3 | 25.5 ± 0.6 | 21.4 ± 1.4 | 9.6 ± 0.8 | 51 ± 10 | 1.6 ± 0.3 | 356.2 ± 8.4 |
| 21 | <47 | 22 ± 3 | 20.5 ± 1.3 | 15.3 ± 3.0 | 9.2 ± 1.7 | 37 ± 9 | 0.9 ± 0.6 | 301.8 ± 16.1 |
| 22 | 75 ± 9 | 40 ± 5 | 62.1 ± 1.9 | 47.2 ± 4.5 | 44.9 ± 2.6 | 80 ± 9 | 4.1 ± 0.8 | < 13.2 |
| 23 | <47 | 33 ± 5 | 30.3 ± 1.5 | 21.4 ± 3.4 | 17.7 ± 2.0 | 33 ± 10 | 2.5 ± 0.6 | 33.8 ± 15.9 |
| 24 | 99 ± 12 | 54 ± 7 | 72.6 ± 1.2 | 57.0 ± 2.8 | 45.8 ± 1.5 | 94 ± 14 | 4.0 ± 0.5 | 516.4 ± 13.4 |
| 25 | 411 ± 45 | 36 ± 5 | 71.1 ± 2.4 | 65.5 ± 5.7 | 36.5 ± 3.2 | 121 ± 13 | 1.7 ± 1.0 | 68.6 ± 24.6 |
| 26 | 81 ± 10 | 29 ± 5 | 50.9 ± 2.0 | 47.0 ± 4.8 | 39.6 ± 2.8 | (¹) | 2.2 ± 0.9 | 233.3 ± 22.4 |
| 27 | 86 ± 10 | 82 ± 11 | 119.9 ± 1.9 | 97.6 ± 4.7 | 43.0 ± 2.2 | 75 ± 15 | 1.1 ± 0.7 | 67.3 ± 16.2 |
| 28 | 98 ± 12 | 42 ± 6 | 60.6 ± 1.7 | 47.9 ± 3.8 | 38.7 ± 2.2 | 50 ± 9 | 2.1 ± 0.7 | 93.3 ± 16.5 |
| 29 | <47 | 20 ± 3 | 23.1 ± 1.2 | 16.5 ± 2.7 | 10.7 ± 1.5 | <20 | 1.2 ± 0.5 | 253.8 ± 14.0 |
| 30 | <47 | 25 ± 4 | 22.8 ± 0.8 | 18.9 ± 1.9 | 8.3 ± 1.1 | 37 ± 10 | 2.7 ± 0.4 | 153.0 ± 9.1 |
| Range | <47 - 411 | 8 - 82 | 4.8 - 120 | 3.3 - 97.6 | 1.0 - 61.8 | <20 - 121 | 0.8 - 4.1 | 15.3 - 516 |
| Mean | 93 ⁽²⁾ | 30 ⁽²⁾ | 33.2 ⁽²⁾ | 27.8 ⁽²⁾ | 17.1 ⁽²⁾ | 46 ⁽²⁾ | 1.9 | 86.7 ⁽²⁾ |
| SD | 1.8 ⁽³⁾ | 1.8 ⁽³⁾ | 2.2 ⁽³⁾ | 2.2 ⁽³⁾ | 2.4 ⁽³⁾ | 1.6 ⁽³⁾ | 0.9 | 2.7 ⁽³⁾ |

(¹) Not determined. (²) Geometric mean. (³) Geometric standard deviation

4. CONCLUSION

Considering the representativeness of the soil samples collected, geometric mean of the activity concentrations obtained in this study could be used by regulatory bodies to establish quality reference values for soils in the Sao Paulo State. The present study covers the main natural radionuclides and those originating from fallout of more radiological concern. Further studies are still in progress, aiming at determining concentration activities of others radionuclides of interest.

REFERENCES

- Bachmann, G. Soil protection policy in German. In: II Seminário Internacional sobre Qualidade de Solos e Águas Subterrâneas. Março, 2000, São Paulo, SP. Anais... São Paulo.
- Companhia de Tecnologia de Saneamento Ambiental. Relatório de estabelecimento de valores orientadores para solos e águas subterrâneas no Estado de São Paulo. São Paulo, SP: CETESB, 2001.
- Companhia de Tecnologia de Saneamento Ambiental. Decisão de Diretoria Nº 195-2005-E, 23 de novembro de 2005.
- Kolluru, R.V.; Bartell, S.M.; Pintado, R.M. and Stricoff, R.S. Risk Assessment and Management Handbook for Environmental, Health and Safety Professionals. New York, NY, McGraw-Hill, 1996.
- U.S. Environmental Protection Agency. Soil screening guidance: technical background document. Washington, D.C.: USEPA, 1996.
- Soares, M.R. Distribution coefficient (K_d) of heavy metals in soils of the State of São Paulo. 202p. (PhD Thesis) – University of São Paulo, 2004
- VRON: Ministry of Housing, Spatial Planning and Environment. Premisses for risk management: annex to the Dutch Environmental Policy Plan. The Hague: Lower House, 1988.
- Soil Survey Staff. Soil Taxonomy: a basic system of soil classification for making and interpreting soil surveys (Agriculture Handbook n.436). United States Department of Agriculture and Natural Resources Conservation Service. U.S. Government Printing Office, Washington, DC, 1999.

Chapter 19

INDOOR RADON: SHORT-TERM AND LONG-TERM INFLUENCE OF PROLONGED PRECIPITATION

Douglas G. Mose, George W. Mushrush and George Siaway

Department of Chemistry, 3E2, George Mason University, 4400 University Drive, Fairfax, VA 22030, Corresponding Author: Douglas Mose, Tel: 703-273-2282, E-mail: dje42@aol.com

Abstract: For long-term indoor radon measurements (91 or more days), home occupants are allowed by the USEPA recommendations to leave their house windows open whenever weather allows. Open windows diminish the partial vacuum normally found in homes (caused by warm air rising through the house), and consequently reduces the inward movement of radon into the house from surrounding soil. However, even under these open-house conditions, indoor radon in our study area increases during rainfall, and long-term radon measurements are higher if taken during a season of above average precipitation. This seasonal effect can result in higher than normal short-term (2-7 day) indoor radon measurements, often taken by home inspectors during the sale of a house.

Key words: Indoor radon, rainfall, soil gases, groundwater transport

1. INTRODUCTION

The United States Environmental Protection Agency and the United States Surgeon General estimate that radon is the second leading cause of lung cancer in the United States. Increased awareness of the health risks posed by elevated concentrations of indoor radon has focused attention on the mechanisms by which radon enters into homes. It is understood that the migration of soil gases is caused by three primary and interacting mechanisms: soil-to-house diffusion, groundwater-to-house transport and house-from-soil convection.

Soil-to-house diffusion is a pushing process by which a gas can migrate from a high concentration as found in soil to an area of low concentration as is normally found in the basement of a house. The following report quantifies the increase in indoor radon that occurs when the radon concentration in the soil around a house is increased by a rising water table below the house foundation and by a falling perched water table just below the surface of the soil around the house.

Groundwater-to-house transport describes the process by which gases dissolved in a fluid migrate through soil as the fluid migrates through the soil. Indoor radon increases when radon dissolved in groundwater enters houses when the groundwater seeps into a home, or when well water is used in house. In either case, waterborne radon diffuses out of the water.

House-from-soil convection is a pulling process, also described as pressure driven gas flow, and is caused by the weak partial vacuum present in a house. Pressure differentials between air pressure inside a dwelling and soil of only a hundredth of a percent can provide a sufficient pressure gradient to facilitate radon entry into a house (Tanner, 1986). This partial vacuum occurs because the upper part of a house is warmer than the lower part, causing air in the house to rise and escape (called "thermal stack effect"). The vacuum can be increased by wind pressures, temperature differentials and changes in barometric pressure. In houses, convection can also be increased by internal mechanical systems (e.g. ceiling fans, forced air heating, air conditioning, etc.) which pulls air out of a house. In

northern Virginia, where many homes have fireplaces, a good example of the thermal stack effect happens when hot gas from burning wood quickly moves up and out a chimney.

Of the three radon-increasing mechanisms, house-to-soil convection is thought to be the major process by which indoor air radon concentrations are increased. Together, diffusion and convection can create extremely high indoor radon concentrations if the radon in soil around a home increases. Our thesis is that if the radon concentration in the soil around a house increases because of rainfall, which causes a rising water table below the house foundation and a falling perched water table just below the surface of the soil around the house, convection and diffusion will cause a greater increase in indoor radon that during times when rainfall is normal or below normal. Possibly there is an upward displacement of radon enriched air from the micro-pores by a rising water table caused by prolonged rainfall. Similarly, development of a perched water table could possibly contribute to the often observed wet-season increase in indoor radon, perhaps by a downward displacement of radon in the pores of the upper few feet of soil around a house.

Intervals of above normal precipitation occur usually in the winter in northern Virginia and southern Maryland, but not consistently. In our study area, the upper portion of the soil around homes is damp and the water table is typically at a depth of 50-100 feet. During prolonged rainfall, the downward moving perched water table (near-surface accumulation of water) can merge with the upward moving water table. Few data are available about the effect of fluctuations in water table depth on the concentration and mobility of soil radon gas. The United States Environmental Protection Agency Manual "Reducing Radon in Structures" states that as water tables rise, it is logical that more soil gas is forced into houses.

In summary, it was the purpose of this study to evaluate the validity of the contention that rainfall differences, as quantified seasonal total precipitation, can be correlated with radon gas concentrations in houses in northern Virginia.

2. METHODOLOGY AND RESULTS

Alpha-track indoor radon monitors were placed in several hundred occupied houses for 3 month intervals that correspond to the seasons. In this study, the detectors were exposed for 91 days, on the first floor, the most lived-in part of the houses (Mose and others, 1991). In the study area, Fairfax County in northcentral Virginia and the adjacent Montgomery County in southcentral Maryland, the weather is monitored daily by about 300 weather stations by volunteers, and the data are compiled and summary reports issued by the National Oceanic and Atmospheric Administration (Cooperative Program Branch W/OSO141X4).

According to the weather summaries, Table 1, the total seasonal rainfall starting from the winter at the end of 1986 through the winter of 1987 ranged from less than 10 inches to more than 15 inches. The median indoor radon measurements from the study homes in northcentral Virginia and southcentral Maryland ranged from 1.6 pCi/L to 2.4 pCi/L. As shown in Table 1, as the rainfall increased, the indoor radon increased.

Table 1. Seasonal summary of rainfall and indoor radon

| Season | Total Average Rainfall | First Floor Median Indoor Radon | Number of Homes |
|----------------|------------------------|---------------------------------|-----------------|
| Spring of 1987 | 7.4 inches | 1.6 pCi/L | 76 |
| Summer of 1987 | 9.9 inches | 1.6 pCi/L | 125 |
| Winter of 1987 | 10.1 inches | 2.1 pCi/L | 100 |
| Fall of 1987 | 10.8 inches | 2.2 pCi/L | 115 |
| Winter of 1986 | 15.1 inches | 2.4 pCi/L | 39 |

3. CONCLUSIONS

This research also shows that variations in indoor air radon concentrations in a home built over terrain with a fluctuating water table could be substantial. This suggests that to test a home or

structure built over this type of terrain, the measurement time could be selected based on an understanding of when the water table rises and falls. Since the nature of the water table and groundwater are of concern when evaluating the migration of many environmental contaminants, this research indicates that water table fluctuations could have an effect on the volume of gaseous emanations of these contaminants.

REFERENCES

- Mose, D.G., Mushrush, G.W., Chrosniak, C., 1991, A Two-Year Study of Seasonal Indoor Radon Variations in Northern Virginia: *Journal of Toxicology and Environmental Health*, v. 33, p. 115-130.
- Tanner Allan B., 1986, Indoor Radon and its Sources in the Ground. Open File Report 86-222. Geological Survey, United States Department of the Interior.

Chapter 20

DETERMINATION OF SCREENING LEVEL FOR SOIL RADIOACTIVE CONTAMINATION

Ana Claudia Peres and Goro Hiromoto

Instituto de Pesquisas Energeticas e Nucleares, Av. Prof. Lineu Prestes 2242, Sao Paulo, SP, CEP 05508-000, Brasil

Abstract: At the present, decisions regarding the clean-up of Brazilian sites contaminated with radioactive isotopes are ressed on a case-by-case basis, since there is no general guidance or recommendation to support actions in the early phases of the problem identification. For chemicals, CETESB - the governmental organization responsible for preventing and controlling environmental pollution in São Paulo State - established quality reference values for prevention and intervention, as the first step to implement a remediation policy based on human health risk assessment. The aim of this study is to develop a methodology for the establishment of target values for radioactive soil contamination as far as possible consistent with and compatible with the approach adopted by CETESB for sites contaminated with chemicals.

The following steps have been addressed in this study: conceptual scenario and model development; codification of the equations in an electronic spreadsheet; selection of proper input values; derivation of the intervention levels for selected radionuclides using Monte Carlo methods. The mathematical model developed was mainly based on the equations used by the U.S. Environmental Protection Agency and by the National Council on Radiation Protection and Measurements for soil screening purposes. Results are presented for selected natural and man-made radioactive isotopes.

Key words: Soil; radioactivity; screening level; target value; contamination.

1. INTRODUCTION

During the 20th century, industrial development was the main cause for the emergence of areas contaminated with harmful substances. During the 1970s, as concerns with environmental issues grew, these areas began to be systematically identified in some countries and clean-up policies implemented. The Superfund program in US is one such example.

In general, soil remediation is an expensive option. Besides, the elapsed time between the identification of the contaminated area and the decision to undertake corrective action typically is too great, due to the complexity of the site-specific studies necessary to a proper characterization of all the associated risks. Despite these problems, governmental agencies from countries such as the Netherlands (VRON, 1988), the USA (U.S.EPA, 1966) and Germany (Bachmann, 2000), among others, have opted to establish target values for soil quality as a first step in the whole process of risk assessment.

In Brazil, the only state to adopt target values for soil contamination – specific to its characteristics – is the State of São Paulo through its governmental agency for pollution control - CETESB. Three levels have been established: (1) quality reference value, indicating the quality level of a soil considered as clean soil, generally associated with the natural concentration of the element of interest; (2) preventing value, above which harmful changes in the soil quality may occur; and (3) intervention value, above which potential risks to the human health exist, considering a generic exposure scenario (CETESB, 2005).

The model used by CETESB to obtain these values was based on that developed by the Netherlands National Institute of Public Health and Environment (VRON, 1994), implemented in the C-SOIL software (Tauw Milieu, 1997).

The list of the elements for which target values are in force includes organic chemicals, volatile organic compounds and heavy metals, all of them potential carcinogens and, therefore, subject to regulatory control. However, it does not include radionuclides. In addition, Brazilian National Nuclear Energy Commission – CNEN –, the federal agency responsible for regulating nuclear activities in the country, has not established target values for radioactive soil contamination either.

This paper describes the methodology proposed to derive intervention levels for radioactive soil contamination in Brazil, as far as possible consistent and compatible with the approach adopted by CETESB for sites contaminated with hazardous chemicals.

2. MATERIALS AND METHODS

Proposed methodology was based mainly on the models developed by the U.S. Environmental Protection Agency (U.S.EPA, 2000a), by the National Council on Radiation Protection and Measurements (NCRP, 1999), and by Companhia de Tecnologia de Saneamento Ambiental (CETESB, 2001). The following exposure pathways were considered: external exposure, inhalation, and ingestion of soil, groundwater, and food.

Values of the input data parameters were chosen using a stochastic approach, according to the best available data for Sao Paulo State; literature data was used otherwise. Intervention levels were derived based on an effective dose to the members of the public of 1 mSv.y^{-1} , taken from the 95th percentile value of the dose distribution.

The annual effective dose for each pathway was calculated according to the following equations:

2.1 External Exposure

$$D_1 = [T_{out} + (T_{in} \times GSF)] \times W_s \times C_s \times ACF \times Df_{ext}$$

D_1 = committed effective dose for external exposure (Sv.yr^{-1})

T_{out} = fraction of time outdoors on contaminated land

T_{in} = fraction of time indoors on contaminated land

GSF = gamma shielding factor

W_s = density correction due to soil moisture

C_s = concentration in soil (Bq.kg^{-1})

ACF = area correction factor

Df_{ext} = external radiation dose factor (Sv.yr^{-1} per Bq.kg^{-1})

2.2 Inhalation

$$Inh = (TSP_{out} \times frs_{out} \times T_{out} \times AV_{out} + TSP_{in} \times frs_{in} \times T_{in} \times AV_{in}) \times C_s \times fr \times fa$$

Inh = inhalation of airborne radionuclides (Bq.yr^{-1})

fr = lung retention factor

fa = absorption factor

TSP = concentration of suspended dust in the air (mg.m^{-3})

frs = fração of soil in the dust

AV = breathing rate ($\text{m}^3.\text{h}^{-1}$)

T = occupation factor (h.d^{-1})

$$D_2 = Inh \times Df_{inh}$$

D_2 = committed effective dose for inhalation of airborne radionuclides (Sv.yr⁻¹)
 Df_{inh} = inhalation dose factor (Sv.Bq⁻¹)

2.3 Ingestion of Soil

$$IngS = AID \times Cs \times fa$$

$IngS$ = ingestion of radionuclides by soil intake (Bq.yr⁻¹)
 AID = annual soil intake (kg.yr⁻¹)

$$D_3 = IngS \times Df_{ing}$$

D_3 = committed effective dose for ingestion of soil (Sv.yr⁻¹)
 Df_{ing} = ingestion dose factor (Sv.Bq⁻¹)

2.4 Ingestion of Groundwater

$$Cpw = \frac{Cs}{\left(Kd + \frac{Vw}{SD}\right)}$$

Cpw = radionuclide concentration in soil pore water (Bq.cm⁻³)
 SD = soil bulk density (g.cm⁻³)
 Vw = water-filled porosity
 Kd = partition coefficient (cm³.g⁻¹)

$$IngA = Qdw \times \frac{Cpw}{DAF} \times fa$$

$IngA$ = ingestion of radionuclides by water intake (Bq.yr⁻¹)
 Qdw = annual water intake (m³.yr⁻¹)
 DAF = dilution/attenuation factor

$$D_4 = InaA \times Df_{ing}$$

D_4 = committed effective dose for ingestion of water (Sv.yr⁻¹)

2.5 Ingestion of Food

2.5.1 Homegrown produce - tubercles

$$Ctb = (Bv_{tb} \times Cs) \times \exp(-\lambda r.th)$$

Ctb = concentration in tubercles (Bq.kg⁻¹)
 Bv_{tb} = root uptake factor (mg.kg⁻¹ wet vegetable / mg.kg⁻¹ dry soil)
 λr = radioactive decay constant (d⁻¹)
 th = time period between harvest and human consumption of the food (d)

2.5.2 Homegrown produce - leaves and fruits

$$Cdp = TSP_{out} \times frs_{out} \times Cs \times DR_{out} \times fi \times [1 - \exp(-\lambda e.te)] \times \frac{1}{Y.\lambda e}$$

Cdp = concentration in vegetables due to foliar deposition (Bq.kg⁻¹)

TSP_{out} = concentration of suspended dust in the outdoor air (kg.m⁻³)

DR_{out} = deposition velocity (m.d⁻¹)

fi = interception factor by edible portion of the vegetable

λe = effective decay constant (d⁻¹)

te = time period that crops are exposed to contamination during the growing season (d)

Y = productivity of the edible portion of the vegetable (kg.m²)

$$Cfl = [(Bv_{fl} \times Cs) + Cdp] \times \exp(-\lambda r.th)$$

Cfl = concentration in leaves and fruits (Bq.kg⁻¹)

Bv_{fl} = root uptake factor (mg.kg⁻¹ wet vegetable / mg.kg⁻¹ dry soil)

$$IngV = (Qtb \times Ctb + Qfl \times Cfl) \times fv \times fa$$

$IngV$ = ingestion of radionuclides by homegrown produce intake (Bq.yr⁻¹)

Qtb = annual intake of tubercles (kg. yr⁻¹)

Qfl = annual intake of leaves and fruits (kg. yr⁻¹)

Ctb = concentration in the tubercles (Bq.kg⁻¹)

Cfl = concentration in leaves and fruits (Bq.kg⁻¹)

fv = fraction of the total consumed vegetables originating from contaminated area

2.5.3 Meat

$$C_f = [(Bv_f \times Cs) + Cdp] \times \exp(-\lambda r.th)$$

C_f = concentration in fodder (Bq.kg⁻¹)

Bv_f = root uptake factor (mg.kg⁻¹ dry vegetable / mg.kg⁻¹ dry soil)

th = time period between harvest and animal consumption of the fodder (d)

$$C_{meat} = C_f \times Q_f \times TQ \times F_{meat}$$

C_{meat} = concentration in meat (Bq.kg⁻¹)

C_f = concentration in fodder (Bq.kg⁻¹)

Q_f = daily animal feed intake (kg.d⁻¹)

TQ = fraction of animal feed originating from contaminated area

F_{meat} = feed to meat transfer factor (d.kg⁻¹)

$$Ing.Meat = Q_{meat} \times C_{meat} \times fv \times fa$$

$Ing.Meat$ = ingestion of radionuclides by meat intake (Bq.yr⁻¹)

Q_{meat} = annual meat intake (kg. yr⁻¹)

C_{meat} = concentration in meat (Bq.kg⁻¹)

fv = fraction of total meat originating from contaminated area

2.5.4 Milk

$$C_{milk} = C_f \times Q_f \times TQ \times F_{milk}$$

C_{milk} = concentration in milk (Bq.L⁻¹)

C_f = concentration in fodder (Bq.kg⁻¹)

Q_f = daily cow milk feed intake (kg.d⁻¹)

TQ = fraction of animal feed originating from contaminated area

F_{milk} = feed to milk transfer factor (d.L⁻¹)

$$Ing.Milk = Q_{milk} \times C_{milk} \times fv \times fa$$

$Ing.Milk$ = ingestion of radionuclides by milk intake (Bq.yr⁻¹)

Q_{milk} = annual milk intake (L. yr⁻¹)

C_{milk} = concentration in milk (Bq.L⁻¹)

fv = fraction of total consumed milk originating from contaminated area

$$IngF = IngV + Ing.Meat + Ing.Milk$$

$$D_5 = IngF \times Df_{ing}$$

$IngF$ = ingestion of radionuclides by total food intake (Bq.yr⁻¹)

D_5 = committed effective dose for ingestion of food (Sv.yr⁻¹)

$$D_{Total} = \sum_{i=1}^5 D_i$$

D_{Total} = total committed effective dose (Sv.yr⁻¹)

Intervention levels were determined for the natural radionuclides ²¹⁰Pb, ²²⁶Ra, ²²⁸Ra, Th-nat and U-nat, and for the man-made radionuclides ⁹⁰Sr, ¹³⁷Cs, ²³⁹Pu e ²⁴¹Am. Three exposure scenarios were considered: agricultural, residential and industrial. Doses to adults only were calculated.

3. RESULTS AND DISCUSSION

Effective doses obtained for each scenario and exposure pathway are presented in Tables 1, 2 and 3. Intervention levels derived in this study are presented in Table 4.

Table 1. Effective dose for agricultural scenario (mSv.ano⁻¹ per Bq.kg⁻¹)

| Radionuclide | | External Exposure | Inhalation | Soil Ingestion | Grounwater Ingestion | Food Ingestion | Effective Dose |
|--------------|--------|-------------------|------------|----------------|----------------------|----------------|----------------|
| Sr-90 | Mean | 2,76E-06 | 1,76E-08 | 2,04E-06 | 3,20E-04 | 7,68E-04 | 1,09E-03 |
| | Median | 2,73E-06 | 1,41E-08 | 7,10E-07 | 5,60E-05 | 3,57E-04 | 5,31E-04 |
| | 95th % | | | | | | 3,70E-03 |
| Cs-137 | Mean | 4,31E-04 | 2,15E-09 | 7,05E-07 | 4,06E-07 | 3,51E-05 | 4,67E-04 |
| | Median | 4,23E-04 | 1,67E-09 | 3,33E-07 | 1,17E-07 | 2,15E-05 | 4,59E-04 |
| | 95th % | | | | | | 6,55E-04 |
| Pb-210 | Mean | 5,25E-07 | 5,75E-07 | 4,92E-05 | 8,77E-06 | 2,17E-04 | 2,76E-04 |
| | Median | 5,05E-07 | 3,94E-07 | 1,73E-05 | 1,87E-06 | 1,17E-04 | 1,66E-04 |
| | 95th % | | | | | | 8,84E-04 |

| Radionuclide | | External Exposure | Inhalation | Soil Ingestion | Grounwater Ingestion | Food Ingestion | Effective Dose |
|--------------|--------|-------------------|------------|----------------|----------------------|----------------|----------------|
| Ra-226 | Mean | 1,42E-03 | 1,68E-06 | 1,67E-05 | 3,29E-05 | 8,64E-04 | 2,33E-03 |
| | Median | 1,39E-03 | 1,28E-06 | 7,78E-06 | 3,76E-07 | 4,90E-04 | 1,99E-03 |
| | 95th % | | | | | | 4,02E-03 |
| Ra-228 | Mean | 7,62E-04 | 1,48E-06 | 6,19E-05 | 1,44E-04 | 3,03E-03 | 4,00E-03 |
| | Median | 7,56E-04 | 8,85E-07 | 1,72E-05 | 1,06E-06 | 1,14E-03 | 2,02E-03 |
| | 95th % | | | | | | 9,69E-03 |
| Th-232 | Mean | 5,21E-08 | 1,54E-05 | 2,00E-05 | 5,66E-05 | 2,19E-05 | 1,14E-04 |
| | Median | 5,10E-08 | 8,90E-06 | 5,79E-06 | 3,36E-06 | 1,04E-05 | 4,66E-05 |
| | 95th % | | | | | | 2,96E-04 |
| U-238 | Mean | 1,18E-05 | 1,71E-06 | 4,04E-06 | 2,36E-03 | 8,79E-06 | 2,38E-03 |
| | Median | 1,14E-05 | 9,87E-07 | 1,17E-06 | 6,20E-05 | 4,08E-06 | 9,08E-05 |
| | 95th % | | | | | | 5,21E-03 |
| Pu-239 | Mean | 3,33E-08 | 2,35E-05 | 1,81E-05 | 3,39E-05 | 2,04E-05 | 9,59E-05 |
| | Median | 3,27E-08 | 1,83E-05 | 6,37E-06 | 9,08E-06 | 1,10E-05 | 6,35E-05 |
| | 95th % | | | | | | 2,32E-04 |
| Am-241 | Mean | 4,36E-06 | 2,10E-05 | 1,48E-05 | 1,63E-04 | 1,67E-05 | 2,20E-04 |
| | Median | 4,23E-06 | 1,44E-05 | 5,21E-06 | 4,51E-06 | 9,01E-06 | 6,06E-05 |
| | 95th % | | | | | | 4,14E-04 |

Table 2. Effective dose for residential scenario (mSv.ano⁻¹ per Bq.kg⁻¹)

| Radionuclide | | External Exposure | Inhalation | Soil Ingestion | Food Ingestion | Effective Dose |
|--------------|--------|-------------------|------------|----------------|----------------|----------------|
| Sr-90 | Mean | 1,54E-06 | 4,77E-08 | 1,30E-06 | 3,77E-04 | 3,80E-04 |
| | Median | 1,51E-06 | 3,59E-08 | 5,25E-07 | 1,67E-04 | 1,72E-04 |
| | 95th % | | | | | 1,30E-03 |
| Cs-137 | Mean | 2,62E-04 | 7,16E-09 | 4,73E-07 | 1,72E-05 | 2,79E-04 |
| | Median | 2,56E-04 | 4,30E-09 | 2,23E-07 | 1,05E-05 | 2,73E-04 |
| | 95th % | | | | | 4,08E-04 |
| Pb-210 | Mean | 2,25E-07 | 2,16E-06 | 3,17E-05 | 1,15E-04 | 1,49E-04 |
| | Median | 2,12E-07 | 1,04E-06 | 1,22E-05 | 6,18E-05 | 8,90E-05 |
| | 95th % | | | | | 4,61E-04 |
| Ra-226 | Mean | 8,61E-04 | 4,84E-06 | 2,17E-05 | 4,32E-04 | 1,32E-03 |
| | Median | 8,32E-04 | 3,30E-06 | 5,10E-06 | 2,43E-04 | 1,16E-03 |
| | 95th % | | | | | 2,24E-03 |
| Ra-228 | Mean | 4,62E-04 | 5,35E-06 | 3,81E-05 | 1,49E-03 | 1,99E-03 |
| | Median | 4,52E-04 | 2,22E-06 | 1,17E-05 | 5,82E-04 | 1,08E-03 |
| | 95th % | | | | | 4,64E-03 |
| Th-232 | Mean | 2,62E-08 | 6,94E-05 | 1,25E-05 | 1,37E-05 | 9,57E-05 |
| | Median | 2,53E-08 | 2,26E-05 | 4,20E-06 | 6,10E-06 | 4,60E-05 |
| | 95th % | | | | | 2,80E-04 |
| U-238 | Mean | 5,07E-06 | 7,69E-06 | 2,53E-06 | 4,98E-06 | 2,03E-05 |
| | Median | 4,73E-06 | 2,50E-06 | 8,49E-07 | 2,25E-06 | 1,33E-05 |
| | 95th % | | | | | 4,78E-05 |
| Pu-239 | Mean | 1,87E-08 | 7,80E-05 | 1,17E-05 | 1,27E-05 | 1,02E-04 |
| | Median | 1,83E-08 | 4,73E-05 | 4,50E-06 | 6,83E-06 | 6,87E-05 |
| | 95th % | | | | | 2,67E-04 |
| Am-241 | Mean | 2,20E-06 | 7,90E-05 | 9,54E-06 | 1,06E-05 | 1,01E-04 |
| | Median | 2,10E-06 | 3,81E-05 | 3,68E-06 | 5,65E-06 | 5,84E-05 |
| | 95th % | | | | | 2,74E-04 |

Table 3. Effective dose for industrial scenario (mSv.ano⁻¹ per Bq.kg⁻¹)

| Radionuclide | | External Exposure | Inhalation | Soil Ingestion | Food Ingestion | Effective Dose |
|--------------|--------|-------------------|------------|----------------|----------------|----------------|
| Sr-90 | Mean | 8,79E-07 | 3,65E-07 | 6,48E-07 | 7,44E-05 | 7,63E-05 |
| | Median | 8,56E-07 | 2,88E-07 | 2,41E-07 | 3,59E-05 | 3,74E-05 |
| | 95th % | | | | | 2,58E-04 |

| Radionuclide | | External Exposure | Inhalation | Soil Ingestion | Food Ingestion | Effective Dose |
|--------------|--------|-------------------|------------|----------------|----------------|----------------|
| Cs-137 | Mean | 1,44E-04 | 4,38E-08 | 2,25E-07 | 3,76E-06 | 1,48E-04 |
| | Median | 1,40E-04 | 3,47E-08 | 1,08E-07 | 2,30E-06 | 1,43E-04 |
| | 95th % | | | | | 2,17E-04 |
| Pb-210 | Mean | 1,41E-07 | 1,17E-05 | 1,55E-05 | 4,96E-05 | 7,70E-05 |
| | Median | 1,32E-07 | 8,48E-06 | 5,85E-06 | 1,84E-05 | 4,15E-05 |
| | 95th % | | | | | 2,10E-04 |
| Ra-226 | Mean | 4,77E-04 | 4,24E-05 | 5,85E-06 | 9,24E-05 | 6,18E-04 |
| | Median | 4,61E-04 | 2,55E-05 | 2,35E-06 | 5,44E-05 | 5,77E-04 |
| | 95th % | | | | | 9,48E-04 |
| Ra-228 | Mean | 2,55E-04 | 3,17E-05 | 1,98E-05 | 3,13E-04 | 6,20E-04 |
| | Median | 2,49E-04 | 1,91E-05 | 5,89E-06 | 1,29E-04 | 4,35E-04 |
| | 95th % | | | | | 1,28E-03 |
| Th-232 | Mean | 1,54E-08 | 3,15E-04 | 6,24E-06 | 1,43E-05 | 3,36E-04 |
| | Median | 1,47E-08 | 1,86E-04 | 1,90E-06 | 2,55E-06 | 1,97E-04 |
| | 95th % | | | | | 9,96E-04 |
| U-238 | Mean | 3,18E-06 | 3,49E-05 | 1,26E-06 | 3,35E-06 | 4,27E-05 |
| | Median | 2,94E-06 | 2,06E-05 | 3,84E-07 | 7,77E-07 | 2,70E-05 |
| | 95th % | | | | | 1,13E-04 |
| Pu-239 | Mean | 1,06E-08 | 4,79E-04 | 5,71E-06 | 1,20E-05 | 4,97E-04 |
| | Median | 1,02E-08 | 3,80E-04 | 2,15E-06 | 2,75E-06 | 3,94E-04 |
| | 95th % | | | | | 1,18E-03 |
| Am-241 | Mean | 1,29E-06 | 4,29E-04 | 4,68E-06 | 9,92E-06 | 4,44E-04 |
| | Median | 1,22E-06 | 3,10E-04 | 1,76E-06 | 2,42E-06 | 3,21E-04 |
| | 95th % | | | | | 1,16E-03 |

Table 4. Intervention Values for Each Scenario

| Radionuclide | Intervention value (Bq.kg ⁻¹) | | |
|-------------------|---|-------------|------------|
| | Agricultural | Residential | Industrial |
| ⁹⁰ Sr | 270 | 770 | 3880 |
| ¹³⁷ Cs | 1530 | 2450 | 4610 |
| ²¹⁰ Pb | 1130 | 2170 | 4760 |
| ²²⁶ Ra | 250 | 450 | 1055 |
| ²²⁸ Ra | 100 | 220 | 780 |
| ²³² Th | 3380 | 3570 | 1000 |
| ²³⁸ U | 190 | 20920 | 8850 |
| ²³⁹ Pu | 4310 | 3740 | 850 |
| ²⁴¹ Am | 2420 | 3650 | 860 |

According to Hiromoto et al. (Hiromoto, 2006), geometric mean background activity concentration values in soils of Sao Paulo State for ¹³⁷Cs, ²¹⁰Pb, ²²⁶Ra, ²²⁸Ra, Th-nat and U-nat are, respectively, 1.9, 46, 17.1, 27.8, 30 and 93 Bq.kg⁻¹ dry weight. Therefore, these results show that intervention values are orders of magnitude higher than background levels for most of these radionuclides, except for ²²⁸Ra and U-nat. In these two cases, intervention values are somewhat closer to the background levels, showing that site-specific data is necessary, in some circumstances, even for screening purposes.

It was observed that, as a general rule, external exposure is the critical pathway for gamma emitters, vegetable ingestion is the critical pathway for beta emitters, and inhalation of suspended particulates, is the critical pathway for alpha emitters. This behavior is more clearly observed in the industrial scenario, where the concentration of dust in the air, that is a user input data, is much higher than in the residential and agricultural scenarios.

4. CONCLUSION

The intervention levels obtained in this study agree with those reported in the NCRP-129 (NCRP, 1999), considering the differences between both methodologies and input data. They also, show that

the model is robust and compatible with the methodology adopted by CETESB for the risk assessment of chemicals.

REFERENCES

- BACHMANN, G. Soil protection policy in German. *In: II Seminário Internacional sobre Qualidade de Solos e Águas Subterrâneas*. Março, 2000, São Paulo, SP. Anais... São Paulo.
- COMPANHIA DE TECNOLOGIA DE SANEAMENTO AMBIENTAL *Relatório de estabelecimento de valores orientadores para solos e águas subterrâneas no Estado de São Paulo*. São Paulo, SP: CETESB, 2001.
- COMPANHIA DE TECNOLOGIA DE SANEAMENTO AMBIENTAL *Decisão de Diretoria nº. 195-2005-E, de 23 de novembro de 2005*. São Paulo, SP: CETESB, 2005.
- HIROMOTO, G.; PERES, A.C.; TADDEI, M.H.; SOARES, M.R., ALLEONI, L.R.F. Radioactive Soil Characterization of the State of Sao Paulo, Brazil. 22nd Annual International Conference on Soils, Sediments and Water. Amherst, MA. 2006 (to be presented).
- NATIONAL COUNCIL ON RADIATION PROTECTION AND MEASUREMENTS. *Recommended screening limits for contaminated surface soil and review of factors relevant to site-specific studies*. Bethesda, MD, NCRP, 1999 (NCRP Report No. 129).
- TAUW MILIEU - ENVIRONMENTAL CONSULTANTS and LABORATORIES. *Csoil software*. Deventer, Netherland: Tauw Milieu, 1997.
- U.S. ENVIRONMENTAL PROTECTION AGENCY. *Soil screening guidance: technical background document*. Washington, D.C.: USEPA, 1996.
- U.S. ENVIRONMENTAL PROTECTION AGENCY. *Soil screening guidance for radionuclides: technical background document*. Washington, D.C.: USEPA, 2000a.
- VRON: MINISTRY OF HOUSING, SPATIAL PLANNING AND ENVIRONMENT. *Premisses for risk management: annex to the Dutch Environmental Policy Plan*. The Hague: Lower House, 1988.
- VRON: MINISTRY OF HOUSING, SPATIAL PLANNING AND ENVIRONMENT. *Intervention values and target values: soil quality standards*. The Hague: VROM, 1994 (DBO/07494013).

PART IX: Remediation

Chapter 21

THE VERSATILITY OF ORGANOCCLAYS FOR PERMEABLE BARRIERS

George R. Alther

Biomim, Inc., Ferndale, MI 48220

Abstract: Permeable barriers at creosote and PNAH containing sediments require a barrier which is permeable and, at the same time, traps creosote and PNAH plumes. Such plumes can also include such organic hydrocarbons as PCP and other chlorinated phenolic compounds, PCB's and BTEX's. Lab tests and actual field applications have shown that organically modified clays are an excellent medium to trap such compounds in groundwater and in sediments at old MPG sites. The PNAH compounds include naphthalene, pyrene, fluorine, anthrazene and others. Organoclays are very well suited to trap these compounds efficiently. Since pesticides are also a serious problem for groundwater and sediments, a brief literature review is included. This article discusses various laboratory tests and actual field results, which have been obtained over the years, showing the suitability of organoclays as a component of permeable barriers.

Key words: organoclay; permeable barriers; sediment stabilization.

1. INTRODUCTION

Permeable barriers at creosote and PNAH containing sediments, require a barrier, which is permeable, and, at the same time, traps creosote and PNAH plumes. Such plumes can also include such organic hydrocarbons as PCP and other chlorinated phenolic compounds, PCB's and BTEX's. Lab tests and actual field applications have shown that organically modified clays are an excellent medium to trap such compounds in groundwater and in sediments at old MPG sites.

The PNAH compounds include naphthalene, pyrene, fluorine, anthrazene and others. Organoclays are very well suited to trap these compounds efficiently. Since pesticides are also a serious problem for groundwater and sediments, a brief literature review is included. This article discusses various laboratory tests and actual field results, which have been obtained over the years, showing the suitability of organoclays as a component of permeable barriers.

2. WHAT IS AN ORGANOCCLAY?

Organoclays have become an important part of the treatment train to remove creosote and PNAH from contaminated groundwater at old wood treating facilities and MGP sites. Organoclays consist of bentonite that is modified with quaternary amines. Bentonite is a volcanic rock whose main

constituent is the clay mineral montmorillonite. This gives the bentonite an ion exchange capacity of 70-90 meq/gram. By exchanging the nitrogen end of a quaternary amine onto the surface of the clay platelets, by cation exchange (Exchanging the sodium or calcium ion on the surface for the nitrogen which is positively charged), the bentonite now becomes organically modified and thus organophilic, which also means hydrophobic (Lagaly, 1984). The clay is arranged in a layered structure, platelets stacked on top of each other. When these platelets are placed into water, the amine chains are activated and stand up like dry hair causing pillaring of the platelets, and allowing the end of the amine chains to stand or dangle into the water, reacting with organics that pass by (Mortland et al, 1986). The chains will then dissolve or partition into large organic compounds such as sparingly soluble chlorinated hydrocarbons. Oil is the most prominent of these (Smith et al, 1990). These same compounds, on the other hand, will blind the pores of activated carbon.

3. CASE HISTORY FROM CLEANING A SUMP SLUDGE

A sump sludge contained a wastewater that required cleaning before it could be discharged. The water was passed through 300 lb of organoclay/anthracite and then discharged. The results are shown in Table 1.

Table 1. Sump Sludge Containing a Wastewater that Requires Cleaning Before Discharge

| Contaminant | Inlet | Outlet | Solubility mg/l |
|---------------------------|--------------|---------------|------------------------|
| TOC | 29% | 65 mg/kg | |
| Oil | 12 mg/kg | 1 mg/l | |
| BOD | 429 mg/kg | 120 mg/kg | |
| COD | 16,084 mg/l | 202 mg/l | |
| Anthrazene | 2,000 mg/kg | <10 mg/l | 0.073 |
| Benzo (A) Anthrazene | 5,300 | <10 | 0.014 |
| Fluorene | 10,000 | <10 | 1.908 |
| Indeno (1,2,3,C,D) Pyrene | 200 | <25 | 0.62 |
| Naphtalene | 29,000 | <10 | 34.4 |
| Phenantrene | 40,000 | <10 | 1.29 |
| Pyrene | 8,000 | <10 | 0.14 |
| TPH | 172,000 | <0.5 mg/l | |

No change-out of organoclay was required. The adsorber ran at 5 gpm.

3.1 Laboratory Test Results with 1,4 Dioxane

A batch test was conducted to determine the ability of a non-ionic organoclay to remove 1,4 dioxane from water. The testing method was:

Sorbent, 1,4 dioxane solution, and organic free, deionized (DI) water were combined in 10 ml glass tubes. The initial concentration of the contaminants was between 300-500 mg/l. The mass of sorbent used was between 0.5 and 1 grams. Tubes carrying the diluted contaminant, but no sorbent, were carried through the test and analyzed to determine losses due to reasons other than sorption to the sorbent. No significant losses were measured, and recovery in all tubes was determined to be greater than 95%. Tubes containing DI water and sorbent were carried through the test and analyzed to determine the possible presence of the contaminant on the sorbent. For each contaminant, negligible amounts were detected. The tubes were capped and shaken for one day at 23 degrees +/- C. After equilibration, the tubes were centrifuged at 2000 g and the supernatant was analyzed by gas chromatography with a flame ionized detector to quantify the concentration of the organic solute. The sorbed concentration of each solute was determined by difference assuming negligible losses of the solute. The results are:

Water was spiked with 958 mg/l 1,4 dioxane aqueous equilibrium concentration. The mass sorbed by 2 grams organoclay was 27.09 mg/l, or 2.709% of the organoclays weight. These results confirm the ability of non-polar organoclays to remove chlorinated organic hydrocarbons from water.

3.2 Laboratory Test Result with Two Nitrobenzenes

Nitro aromatic compounds are used by industry in pesticides, explosives, solvents, and intermediates in chemical synthesis (Boyd et al, 2001). These contaminants appear in soils and sediments and can be toxic to humans and animals. The ability of a powdered, non-polar organoclay to remove substituted nitrobenzenes from water was tested in the lab with the same method as 1,4 dioxane. The compounds tested for are 1,3-Dinitrobenzene and 1,3,5-Trinitrobenzene. The same testing method was used as for 1,4 dioxane (see above). The results are shown in table 2.

Table 2. Ability of a Powdered, Non-Polar Organoclay to Remove Substituted Nitrobenzenes From Water

| | Equilibrium Aqueous Concentration (mg/l) | Mass Sorbed (mg/l) | % by Weight |
|-----------------------|--|--------------------|-------------|
| 1,3-Dinitrobenzene | 157.7 | 6.4 | 0.644 |
| 1,3,5-Trinitrobenzene | 38.3 | 12.0 | 1.201 |

These results show that a regular organoclay can be used to fixate substituted nitrobenzene compounds, thus it is a viable component of permeable barriers.

3.3 Case History for Federal Creosote Superfund Site

The groundwater at this site showed the following data:

- COD influent: 68 ppm, primarily PCP and other phenols.
- 10-20 ppm benzene.
- COD effluent after organoclay tank: 19.5 ppm
- After lead Granular activated carbon tank: Non detect.

TSS readings were 35 ppm after the lead carbon unit. When organoclay was included, the effluent after organoclay was 3 ppm. TSS were primarily iron 3. Carbon removed all of the benzene.

- Flow rate: 170 gpm
- Organoclay used: 20,000 lb; activated carbon used: 40,000 lb.

Table 3. Non-Ionic Organoclays' Removal Capacity of Phenolic Compounds as Determined by Batch Tests (Alther, 1997)

| Concentration | 25ppm in Water | Solubility |
|--------------------------|----------------------------|------------|
| Phenol | 78.2% of organoclay weight | 86 g/l |
| 2,4,6 Trichlorophenol | 98.3% of organoclay weight | 800 mg/l |
| 3 Chlorophenol | 89.8% of organoclay weight | 27.7 g/l |
| *Pentachlorophenol (PCP) | 87% of organoclay weight | 80 mg/l |

*This means that 100 grams of organoclay can remove 87 grams of PCP (Alther, 1997).

Table 4. Literature Review of the Ability of Organoclays to Remove Pesticides. A comprehensive analysis of pesticide removal by organoclays, from water, is found in Sanchez-Martin, et al, 2006. The following pesticides were studied:

| Common Name | Chemical Formula | Water Solubility |
|-------------|--|------------------|
| Penconazole | 1-[2-(2,4-dichlorophenyl)pentyl]-1,2,4-triazole | 73 |
| Linuron | 3-(3,4-dichlorophenyl)-1-methoxy-1-methylurea | 81 |
| Atrazine | 2-chloro-4-ethylamino-6-isopropylamino-1,3,5-triazine | 30 |
| Alachlor | 2-chloro-2',6'-diethyl-N-methoxymethylacetanilide | 240 |
| Metalaxyl | methyl N-(2,6-dimethylphenyl)-N-(methoxyacetyl)-DL-alanite | 8400 |
| Lindane | | 10 ppm |

(From Sanchez-Martin, et al, 2006)

Comparing these solubilities with organic hydrocarbons of known affinity to organoclays, we surmise that the first 4 and Lindane will be easily removed. Excellent results were also reported by Hermosin and Cornejo (1992) for adsorption of 2,4-D pesticide (2,4-dichlorophenoxy acetic acid) by standard organoclays. Tests conducted in our laboratory revealed good removal capacity by non-ionic organoclay for alachlor, diazinin, metalochlor, trifuralin, and 2,4,5-T.

The authors of the pesticide article used a different organoclay, but the results when compared to the quaternary amine (octadecyltrimethylammonium bromide) used in this study will not be markedly different (di-methyl di-hydrogenated tallow ammonium chloride). Those authors concluded that soils containing organoclays provide barriers, which drastically decrease the mobility of these pesticides.

The lab results obtained from a mini-column test are shown in table 5 (Alther, 2004, 2002).

Table 5. Lab Results Obtained from a Mini-Column Test (Alther, 2004, 2002).

| | Solubility | % By Organoclay Weight Removed |
|-------------|------------|--------------------------------|
| Benzene | 1800 mg/l | 39 |
| Toluene | 535 | 44 |
| o-Xylene | insoluble | 44 |
| Naphthalene | 34.4 | 24.3 |
| PCB 1260 | insoluble | 52 % by clay weight |

Other case histories showed excellent removal capacity of organoclay for trichloroethene (sol. 1100 mg/l), and 1,1,1-dichloroethene (sol. 335 mg/l).

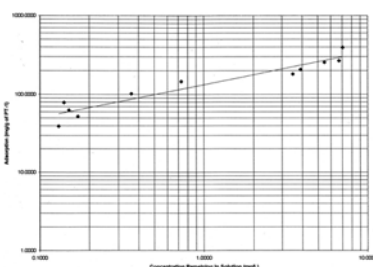

FIGURE 1A:
Organoclay Naphthalene Isotherm

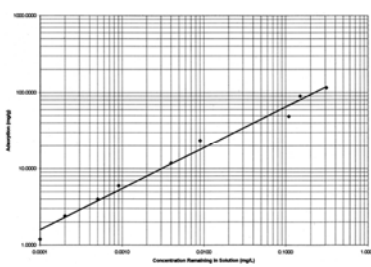

FIGURE 1B:
Organoclay Isotherm with PCB-1260
Adsorption = Concentration
 $\wedge(0.5373441)*10\wedge(2.352119)$

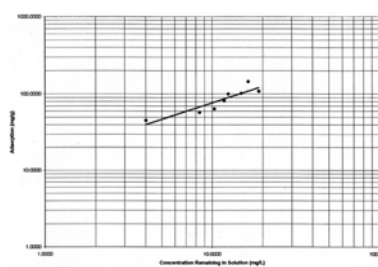

FIGURE 1C:
Organoclay Adsorption of Xylene (ortho)
Adsorption = Concentration
 $\wedge(0.708464989)*10\wedge(1.178918)$

Figure 1. Isotherms for Three Compounds conducted by the ASTM Isotherm Method.

4. SUMMARY REPORT OF BATCH EXPERIMENTS INVESTIGATING THE SORPTION OF TCE ONTO PT-1 ORGANOCLAY POWDER

This report presents data from batch experiments studying the sorptive capacity of PT-1 sorbent to TCE solutions. Batch sorption experiments were performed by combining sorbent, aqueous TCE solution, and organic-free deionized (DI) water in 15-mL glass tubes. Sorbent mass used in each isotherm experiment was 0.3 g. The aqueous TCE solution was prepared at a concentration of 442 mg/L TCE. The aqueous TCE solution was mixed with DI water prior to contacting the sorbent materials in the following ratios: 100% (v/v) TCE solution; 80% TCE solution/20% DI water; 60% TCE solution/40% DI water; 40% TCE solution/60% DI water; 20% TCE solution/80% DI water.

The tubes were capped and shaken for 1 day at 23 ± 1 °C to allow sufficient time to reach equilibrium. The difference between the initial and final (equilibrium) TCE mass in the aqueous phase was considered equal to the mass sorbed to the solid phase. Samples were analyzed using gas chromatography. The results of sorption experiments were fit to Langmuir, Freundlich or linear isotherm, as described by equations 1 to 3 respectively:

$$C_s = \frac{bC_e Q}{1 + bC_e} \quad \text{equation 1}$$

$$C_s = K_f \cdot C_e^n \quad \text{equation 2}$$

$$C_s = K_d \cdot C_e \quad \text{equation 3}$$

where C_s = equilibrium sorbed metal concentration (mg/g), b (1/mg) and Q (mg/g) are fitted isotherm; parameters, C_e (mg/L) is the equilibrium aqueous solute concentration and K_d = sorption distribution; coefficient (L/g), K_f = Freundlich coefficient.

Results in this report are presented below in Figure 2, Table 6 and 7.

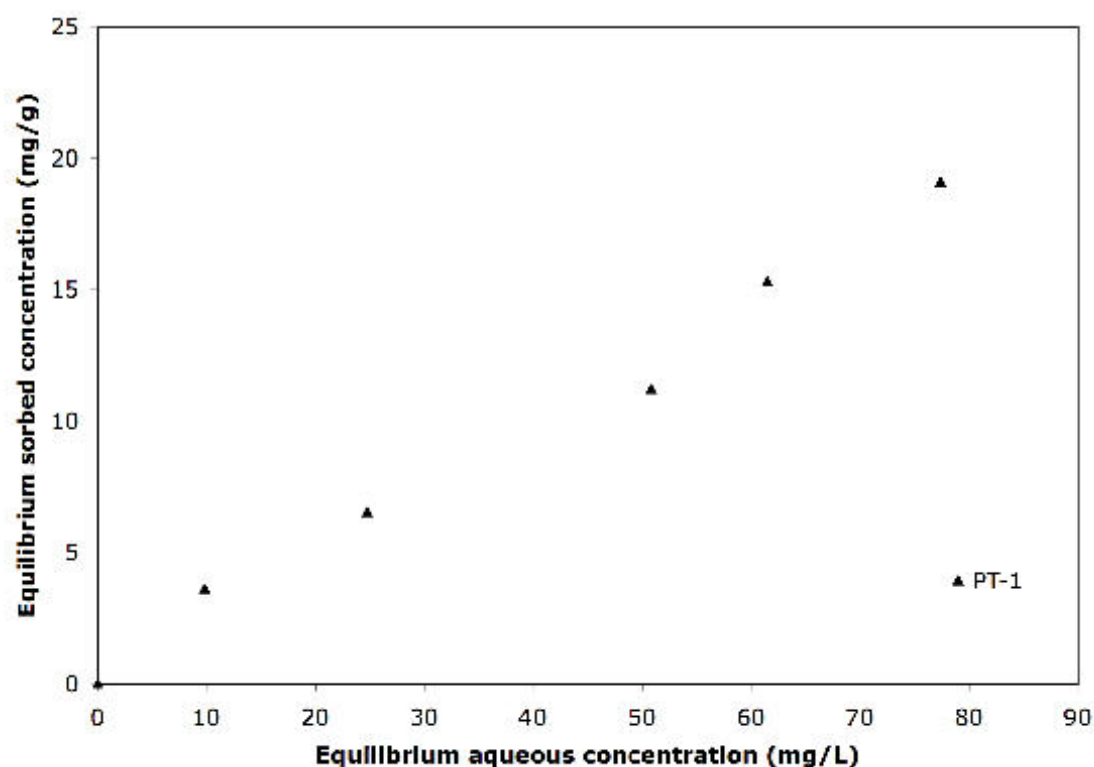

Figure 2. Sorption of TCE onto PT-1

Table 6. Estimated Mass of TCE Sorbed per Mass of Sorbent in mg/g, and Percent Basis.

| | Initial Concentration (mg/L) | Equilibrium aqueous concentration (mg/L) | Equilibrium sorbed concentration (mg/g) | Percentage Sorbed (%) |
|--------|---------------------------------|---|--|--------------------------|
| PT-1_0 | 0.00 | 0.00 | 0.00 | 0.00 |
| PT-1_1 | 93.61 | 9.81 | 3.64 | 0.36 |
| PT-1_2 | 193.14 | 24.73 | 6.55 | 0.65 |
| PT-1_3 | 278.68 | 50.79 | 11.22 | 1.12 |

| | Initial Concentration (mg/L) | Equilibrium aqueous concentration (mg/L) | Equilibrium sorbed concentration (mg/g) | Percentage Sorbed (%) |
|--------|---------------------------------|---|--|--------------------------|
| PT-1_4 | 375.38 | 61.43 | 15.31 | 1.53 |
| PT-1_5 | 470.74 | 77.35 | 19.12 | 1.91 |

Table 7. Estimated Values for the Sorption Distribution Coefficients for PT-1

| Sorbent | Linear | | Langmuir | | | Freundlich | | |
|---------|-------------|-------|----------|----------|-------|------------|-------|-------|
| | K_d (L/g) | R^2 | Q (mg/g) | B (l/mg) | R^2 | K_f | 1/n | R^2 |
| PT-1 | 0.244 | 0.989 | 4473 | 0.00005 | 0.989 | 0.310 | 0.941 | 0.989 |

The results obtained fit with high regression coefficients all the isotherm models tested. However, the linear tendency of the data agrees with previous research. Linear isotherms for non-polar compounds indicate that the sorption is caused by TCE partitioning between water and the organic matter phase formed by the long chain of quaternary ammonium cations.

5. CONCLUSIONS

These data show the ability of organoclays to remove or fixate a variety of recalcitrant compounds of low solubility from water and in soils. There is an industry in existence which manufactures and sells organoclays for such applications, with a successful track record of 20 years.

REFERENCES

- Alther, G. R., 2004, Some practical observations on the use of Bentonite, *Env. & Eng. Geoscience*, X(4):347-359.
- Alther, G. R., 2002, Using Organoclays to Enhance Carbon Filtration, *Waste Mgmt* 22:507-513.
- Alther, G. R., 1996, Organically modified clay removes oil from water, *Waste Mgmt* 15(8):623-628.
- Boyd, S. A., Guanyao, S., Teppen, B. J., and Johnson, C. T., 2001, Mechanism for the adsorption of substituted nitrobenzenes by Smectite clays, *Envir. Science and Technol.*, 35(21):4227-4234.
- Hermosin, M. C., and Corneo, J., 1992, Removing 2,4-D from water by Organoclays, *Chemosphere*, 224(10):1493-1503.
- Lagaly, G., 1984, Clay-organic reactions, Interaction, *Phil. Trans. R. Soc. London*, A-311:315-332.
- Mortland, M. M., Shaobai, S., and Boyd, S. A., 1986, Clay-organic complexes as adsorbants for phenols and chlorophenols: clays & clay minerals, 34(5):581-585.
- Sanchez-Martin, M. J., Rodriguez-Cruz, M. S., Andrades, M. S., and Sanchez-Camazano, M., 2006, Efficiency of different clay minerals modified with cationic surfactant in the adsorption of pesticides: influence of clay type and pesticide hydrophobicity, *Applied Clay Science*, 31(3-4):216-228.
- Smith, J. A., Jaffe, P. R., and Chiou, C. T., 1990, Effect of ten quaternary ammonium cations on tetrachloromethane sorption to clay from water, *Environ. Sci. Technol.* 24:1167-1172.

Chapter 22

THE EFFECT OF BULKING AGENT AND INITIAL CONTAMINANT CONCENTRATION ON THE BIODEGRADATION OF TOTAL PETROLEUM HYDROCARBONS

Ramona Boodoosingh, Christopher Swan, Anne Marie Desmarais, Denise M. Beckles

Department of Civil and Environmental Engineering, Tufts University, Medford, MA 02155; Department of Chemistry, The University of the West Indies, St. Augustine, Trinidad, W.I.

Abstract: Bioremediation is one of the most cost-effective and environmentally friendly methods to remediate many different types of waste materials widely used by many private and public entities. Although the parameters that affect the rate of bioremediation differ for each project, some parameters can be more easily controlled in the field than others. For example, effective microbial action is crucial to the success of bioremediation. However, microbes can be detrimentally affected by an initial contaminant concentration that is too high. In addition, the type of bulking agent or aggregate used affects the ability of the mixture to retain moisture, the amount of drainage, aeration and ultimately the length of time for biodegradation. A two-month field study was conducted in Trinidad and Tobago on crude oil contaminated waste. This paper will look at the effect of two parameters, initial concentration and type of bulking agent, on the rate of biodegradation of Total Petroleum Hydrocarbons (TPH) in the oily waste being treated in this tropical environment. A nutrient-supplying bioremediation agent was used to enhance the bioremediation process. The results of this study can assist in the design of effective bioremediation projects in tropical environments.

Key words: bioremediation; total petroleum hydrocarbons; initial contaminant concentration; aggregate type; bioaugmentation.

1. INTRODUCTION

For many companies that produce toxic, and/or hazardous waste by-products from operations and production, remediation technologies play a vital role in enabling compliance with environmental laws and guidelines. Bioremediation technologies use naturally-occurring microbes to transform waste into (normally) less toxic materials (Cerniglia and Heitkamp, 1989, Sutherland, et al., 1995). Bioremediation has been used extensively for many years as a successful method of treatment for hydrocarbon-contaminated waste (Anderson, 1995).

The oil and gas extraction industry such as that found in Trinidad and Tobago, produces large amounts of hydrocarbon-contaminated waste. With the advent of the Environmental Management Act in 1995, the local oil and gas sector has become more active in investigating and utilizing biological treatment schemes, the most popular of which involve some sort of landfarming (Glasgow, et al., 2003).

As practiced in Trinidad and Tobago, landfarming involves aeration and mixing of contaminated soil by tilling, adding nutrients (and in some cases microorganisms), and controlling moisture content by periodic addition of water. Companies generally excavate the contaminated soils and treat it on biopads with leaching barriers (compacted clay, cement or plastic) constructed to control contaminant infiltration into the ground. The nature of the waste material determines whether any additional treatment or augmentation is used in the landfarming process.

In this study, the waste material was the residual material remaining after de-oiling of tank bottom and settling pond sludge at British Petroleum Trinidad and Tobago. This material consisted of a mixture of oily wax, bottom sediments and possibly saline water. The heavier components of oil tend to flocculate out of solution and settle at the bottom of storage vessels. These components can include asphaltenes, resins, paraffin/wax, diamonoids, and formation solids. However, the settled material has been shown to consist primarily of paraffin/wax, asphaltenes and inorganic mineral material. Also, the settled sediment may contain some oil trapped within the solids (Anonymous, 2003).

This waste material is very dense, and presents a clay-like exterior. In the landfarming process in this study, bulking agents are used to open up the material's structure, allowing air and water to enter. Without this, biodegradation processes would be very limited, as the physical factors most critical for bioremediation are the bioavailability of contaminants to microorganisms, presence of water, and a supply of suitable electron acceptors (oxygen in this case) (Eweis, et al., 1998). Currently, fill sand is used as the bulking agent. In addition, the bioremediation agent Oil Gator (Gator International, Penticton, British Columbia) is added to assist the bioremediation process. Oil Gator is made from the fibers of the cotton seed plant; Oil Gator had been modified to provide necessary nutrients for the growth of the microbes included in the bioremediation agent and also to prevent the easy runoff of waste materials it is being used to treat (Oil Gator International, 2005). It is not often clear whether these commercial bioremediation products developed in temperate countries have any positive effect on treatment systems in the tropics.

In this study, the system currently in place for the treatment of residual material was evaluated. In addition, the effect of changing the type of bulking agent and the ratio of bulking agent to residual material was determined.

2. MATERIALS AND METHODS

2.1 Site Description

The pilot field study was located at Galeota Point, in the extreme south-east of the island of Trinidad. Historically, this area has been the site of significant oil and gas exploration and production. The study began on October 27, 2002, during the island's wet season, with daily temperatures ranging from 27.4 to 32.4 °C and daily rainfall ranging from 0 to 44 mm. The small remediation units were set up to simulate a landfarming process, and were exposed to the natural environment for the entire duration of the study.

2.2 Experimental Design

Small remediation units were designed to simulate landfarming processes, while allowing easy sampling of soil and leachate. Plastic buckets (10 L) were equipped with overflow holes 15 cm from the bottom, and filled with approximately 15 cm of gravel to facilitate easy drainage. A sampling port at the bottom of the container allowed collection of any leachate. To further parallel the treatment of the site landfarming units, the study units were treated with the same commercial bioremediation agent Oil Gator (Gator International, Penticton, British Columbia). Oil Gator is produced from cotton fibers treated with nutrients (nitrogen, sulphur and phosphorus). It works by encapsulating liquid oil and by stimulating the biodegradation of indigenous bacteria (Oil Gator International, 2005).

Aggregate test units each received a mixture of Oil Gator (350 g), oily sand and one of three bulking agents, gravel, sharp sand or sawdust (1:2 v:v). For each type of bulking agent, there were three units and one control, which consisted of oily sand only. Initial concentration test units each received a mixture of Oil Gator (350 g), oily sand and fill sand at 33%, 50%, 66% and 100% oily sand (by volume, in triplicate). The units were then placed out in the same area as the ongoing landfarming process. Each unit was thoroughly mixed twice a week to allow good aeration. After loading, each unit was sampled at day 0, 28 and 62, and analyzed for total petroleum hydrocarbons and oil and

grease – cite the Methodology used for the analyses, particularly for TPH. Was it a colorimetric or spectrophotometric method?

The aggregates chosen in this study were the most inexpensive and readily available in the area. Cost constraints prevented the determination of porosity, density and particle size in the aggregates. However, in Figure 1, it is possible to obtain an idea of the comparative sizes of the materials used in the study.



Figure 1. Appearance and relative size of the different bulking agents used in this study. From left to right: fill sand, gravel, sharp sand and sawdust. The length of each picture corresponds to a length of 7.7 cm.

2.3 Analytical Methods

Soil samples were taken from each bucket at time 0, 28 and 62 days. Leachate samples were taken at time 28 days. At 62 days, there was no leachate in the collection containers. All samples were analysed for total petroleum hydrocarbons (TPH) using Method XXXX and oil and grease (O&G). For this study, it was not important to know what compounds were present, so a total TPH methodology was used (NOTE: TPH methodologies focus on compounds in specific ranges, so it is important to note the method used. The participants at this conference will be well aware of TPH methods and of more sophisticated methods, so it is important to specify what methods were used).

All samples were analyzed by an external laboratory (Analytical Services Unit, University of the West Indies, St. Augustine, Trinidad) using US EPA Method 9071B (US EPA, 1998) okay – include this info above for solid samples and US EPA Method 1664 (US EPA, 1999) for leachate samples. These methods detect petroleum hydrocarbon compounds in the C12 – C 22 range, and may detect compounds with more than 22 carbons if they dissolve in the hexane extractant. In summary, for soil samples, this involved the removal of any foreign objects such as sticks, leaves and rocks and mixing the sample (10 g) thoroughly with sodium sulphate in an extraction thimble. The dried soil sample was then extracted in a Soxhlet apparatus with dichloromethane as the solvent. The solvent was removed, and the oily residue weighed to give the total mass of oil and grease. To measure the TPH of the sample, the oil and grease component was redissolved in dichloromethane followed by the addition of silica gel. After the silica gel was removed, the solvent was removed and the oily residue weighed to give the total mass of total petroleum hydrocarbons. For the soil samples, the values for O&G and TPH were given in terms of percentage by mass.

For leachate samples, the samples were extracted with n-hexane using liquid-liquid extraction. The solvent was dried with sodium sulphate and filtered. The solvent was removed and the oily residue weighed to give the total mass of oil and grease. The TPH measurement was similar to that described for soil samples. For leachate samples, the values for O&G and TPH were given in terms of parts per million.

3. RESULTS AND DISCUSSION

This short field study indicated that the company's current oily sand bioremediation system may not be operating optimally. Oil and grease (O&G) as well as total petroleum hydrocarbon (TPH) were used as indicators of contaminant removal in this study for two reasons: cost effectiveness and ease of analysis. Figure 2 illustrates the effect of varying the bulking agent on contaminant removal

efficiency. Using O&G, both gravel and sawdust appeared to produce better contaminant removal than fill sand ($p = 0.05$), the current bulking agent.

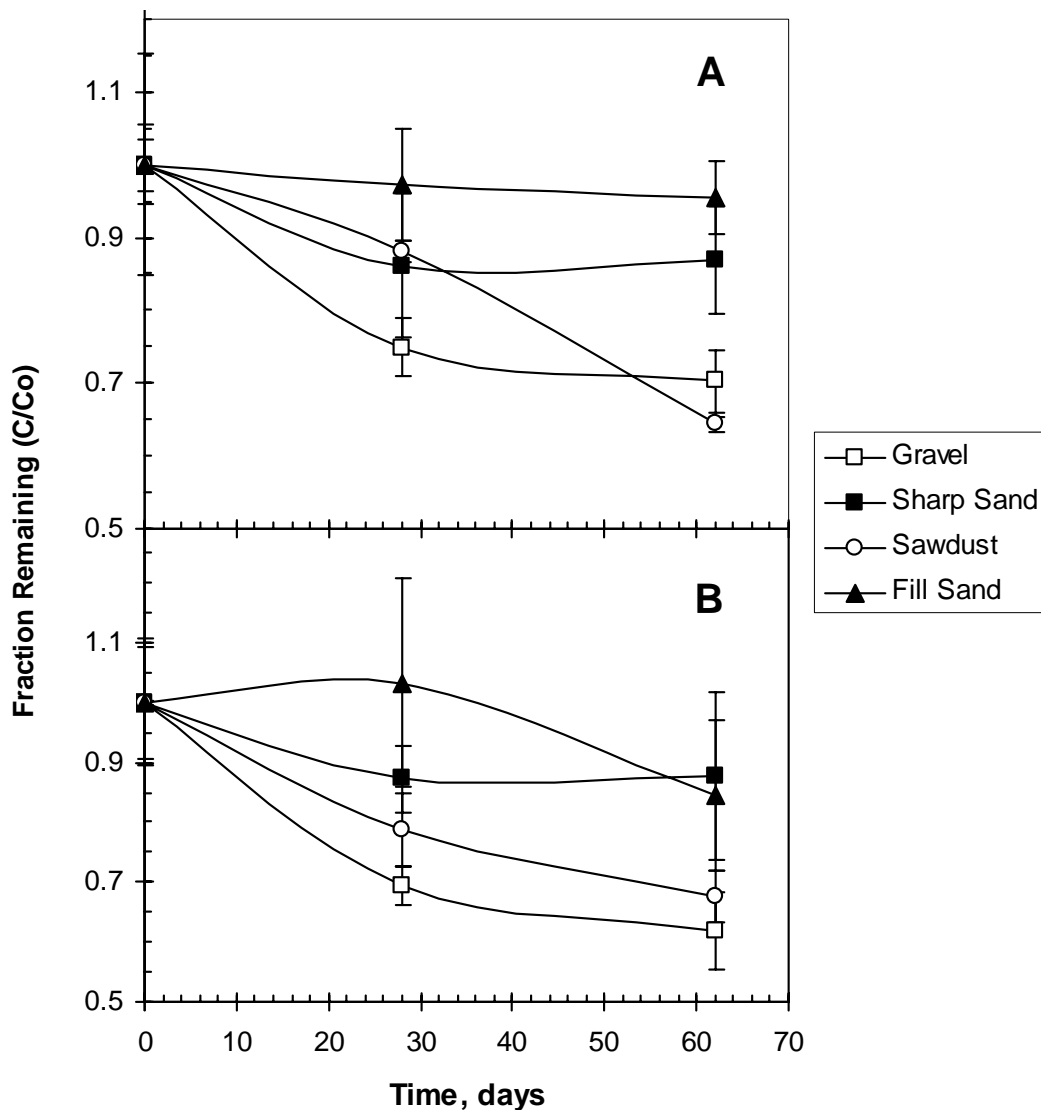

Figure 2. The effect of different bulking agents on the bioremediation of oily sand. **A**: oil and grease; **B**: total petroleum hydrocarbons. The bulking agent currently used in the remediation project (fill sand) is used as the control. Error bars represent one standard deviation, $n = 3$.

This pattern holds for the TPH analysis as well ($p = 0.10$), though there is more uncertainty in the TPH results. Of the two bulking agents that resulted in increased contaminant removal, it is interesting to note the consistent removal found in the sawdust units. The removal of contaminants in the gravel units appears to decline with time, resulting in a leveling out of the graphs in Figure 2. In contrast, the sawdust units appear to be exhibiting consistent removal, with what looks like the likelihood for additional removal after Day 62. This observation suggests that in fact the addition of an organic bulking agent may assist in the bioremediation process. There are a number of other studies that indicate that the presence of alternative carbon sources can assist in the removal of petroleum compounds (Felsot and Dzantor, 1997). In most of these studies, the increase in removal is

attributed to the ability of the alternate carbon source to sustain higher biomass than the oil material alone. As a result of the greater number of organisms present, there is greater biodegradation (Rosenbrock, et al., 1997, Sarkar, et al., 2005). Other studies have found a variety of processes that can improve biodegradation performance, ranging from cometabolism (Stringfellow and Aitken, 1995, Walter, et al., 1991) to augmentation (Bouchez, et al., 1995, Juhasz, et al., 1996). In addition, the ability of organic bulking agents to absorb oil has been reported as an advantage to bioremediation, and is one of the characteristics of the Oil Gator material, as noted in their promotional material (Oil Gator International, 2005). The results of this study are inconclusive in this area, as the leachate results from Day 28 indicate highly variable levels of TPH in the leachate from the sawdust units. Therefore, it is not possible to determine whether or not the sawdust aided leachate reduction. However, the results of Figure 2 do suggest that an organic bulking agent such as sawdust or bagasse, both readily available locally, would be a better prospect than a mineral bulking agent like sand or gravel.

The effect of changing the ratio of oily sand to bulking agent on contaminant removal is shown in Figure 3. Using O&G, the 33% and 50% oily sand reactors produced better contaminant removal than 66% oily sand ($p = 0.05$), the system currently in place. The pattern is slightly different for the TPH analysis, with only the 50% oily sand reactors producing better contaminant removal ($p = 0.10$). This result would appear to suggest that a smaller fraction of oily material would result in improved performance. The poor performance of bioremediation in treating higher levels of contamination in soils can be traced to a number of factors. Toxicity effects can occur, resulting in the death of degrading microorganisms and reduced bioremediation performance. Normal alkanes in the $C_5 - C_{10}$ range are inhibitory to many hydrocarbon degraders at high concentrations, because as solvents they disrupt lipid membranes, but compounds in this range were not anticipated in the oily residual material used in this investigation.(Eweis, et al., 1998).

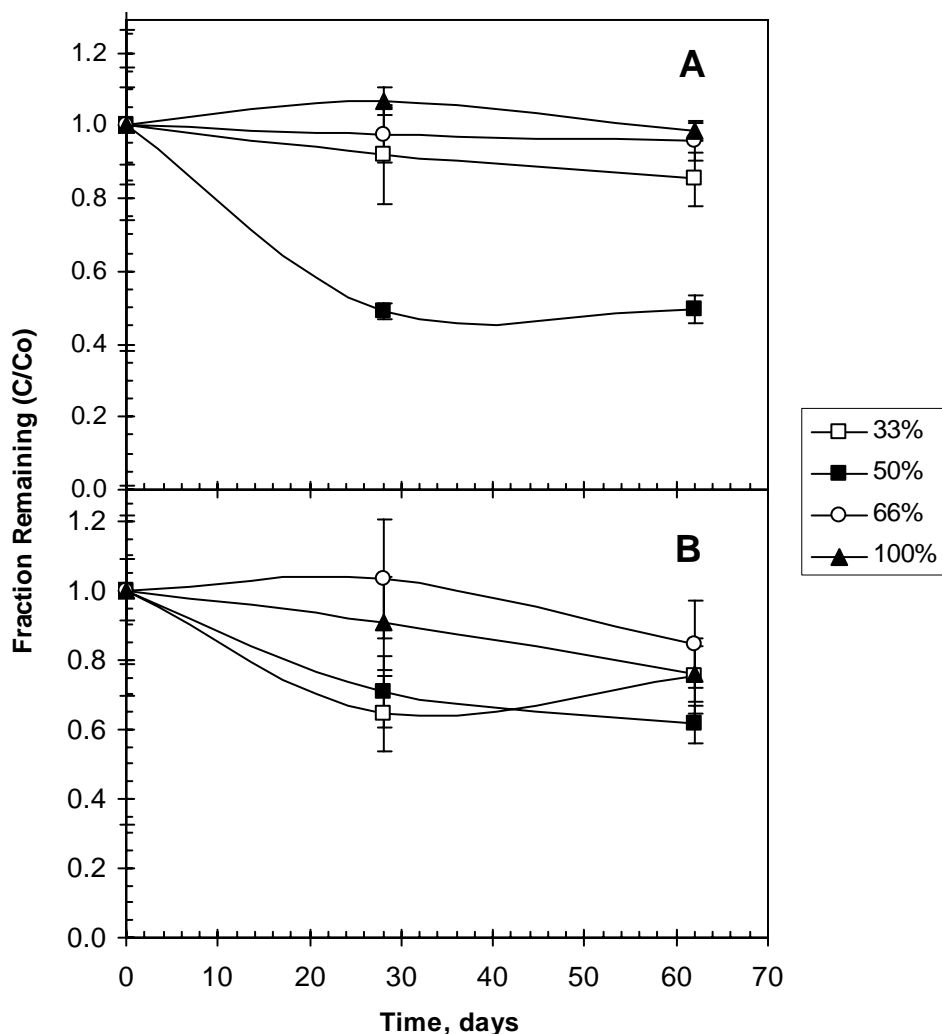

Figure 3. The effect of different oily sand:bulking agent ratios on the bioremediation of oily sand. **A:** oil and grease; **B:** total petroleum hydrocarbons. The bulking agent currently used in the bioremediation process (fill sand) was used in all cases. 100% oily sand was used as the control. Error bars represent one standard deviation, $n = 3$.

While some comment can be made about the effect of changing the concentration and composition of the bioremediation matrix, there is some uncertainty about the cause of these differences. There are two avenues for loss of petroleum compounds in the field units – biological removal and physicochemical removal. Ideally, all removal should be biological – with the contaminant material being degraded by microorganisms to less harmful compounds. In addition, removal by abiotic chemical reactions like photooxidation, volatilisation and leaching are also possible (Park, et al., 1990, Payne and Phillips, 1985, Wild and Jones, 1993). The results of this study are inconclusive concerning the actual method of contaminant removal. Leachate samples were only available on Day 28, as there was no leachate to be collected at the second sampling event on Day 62. In addition, the leachate results were quite variable, as can be seen in Table 1. Not only were concentrations variable, not all of the reactors units contained leachate. However, some information may still be gleaned from this data.

Table 1. Total petroleum hydrocarbon levels in leachate collected on Day 28 from the different types of field unit. All TPH values in ppm.

| Bulking Agents | <u>Gravel</u> | <u>Sharp sand</u> | <u>Sawdust</u> | <u>Fill sand</u> |
|--------------------------------------|---------------|-------------------|----------------|------------------|
| Unit 1 | 27.9 | 24.2 | ND | 7.4 |
| Unit 2 | 11.5 | ND* | 5.36 | 16.7 |
| Unit 3 | 31.3 | 47.4 | 46.7 | 1.96 |
| Oily Sand:Bulking Agent Ratio | <u>33%</u> | <u>50%</u> | <u>60%</u> | <u>100%</u> |
| Unit 1 | ND | 43.9 | 7.4 | ND |
| Unit 2 | ND | 18.7 | 16.7 | 1.35 |
| Unit 3 | 36.1 | 36.1 | 1.96 | ND |

ND: No leachate was present on Day 28.

An examination of the leachate results presented in Table 1 indicates that the leachate from all of the test reactors on Day 28 had a higher concentration of TPH than the fill sand control reactor. It is possible, then, that at least some of the additional removal observed in both the gravel and sawdust units was due to removal in leachate, and not by bacterial degradation. This is also seen in the results comparing the different ratios of oily sand to bulking agent. Table 1 shows that on Day 28, the level of TPH in the leachate decreases as the oily sand ratio increases. The oily sand material was extremely dense, clay-like in texture, with limited porosity. The addition of the sand is necessary to allow air and moisture into the contaminated material to assist biodegradation processes (Dibble and Bartha, 1979, Eweis, et al., 1998). However, this increase in porosity would also increase the possibility of contaminant loss through leaching. It is interesting to note that leachate TPH levels were lowest in the 100% oily sand reactors.

This study determined that the system currently in place for the treatment of residual material could be improved. Bioremediation could be improved by changing the bulking agent to an organic material, such as sawdust or bagasse, instead of mineral material (fill sand) as is used now. In addition, a lower residual material to bulking agent ratio may result in better contaminant removal. There was some uncertainty surrounding the cause of contaminant removal in the field units. As such, any changes in the company's bioremediation setup would have to be accompanied by more stringent mechanisms to contain runoff and leachate, allowing for the collection and treatment of any contaminated liquids produced in the bioremediation process.

REFERENCES

- Anderson, B.C. 1995. Bioremediation. In: Innovative Site Remediation Technology, Alexandria, VA, Academy of Environmental Engineers.
- Anonymous. 2003. Wax Overview. www.igiwax.com/wax_overview.shtml#petroleum. Accessed 13 July 2003.
- Bouchez, M., Blanchet, D. and Vandecasteele, P. 1995. Degradation of polycyclic aromatic hydrocarbons by pure strains and by defined strain associations: inhibition phenomena and cometabolism. *Appl. Microbiol. Biotechnol.* 43, 156-164.
- Cerniglia, C.E. and Heitkamp, M.A. 1989. Microbial degradation of polycyclic aromatic hydrocarbons (PAH) in the aquatic environment. In: *Metabolism of Polycyclic Aromatic Hydrocarbons in the Aquatic Environment*, pp. 41-68. (Varanasi, U., Ed. Boca Raton, FL, CRC Press.
- Dibble, J.T. and Bartha, R. 1979. Effect of environmental parameters on the biodegradation of oil sludge. *Appl. Environ. Microbiol.* 37, 729-739.
- Eweis, J., Ergas, S., Chang, D. and Schroeder, E. 1998. *Bioremediation Principles*. New York, WCB/Mc Graw-Hill.
- Felsot, A.S. and Dzantor, E.K. 1997. Potential of biostimulation to enhance dissipation of aged herbicide residues in land-farmed waste. *ACS Symp. Ser.* 664, 77-91.
- Glasgow, D.M., Ramnath, K., Mohammed, A. and Beckles, D.M. 2003. Bioremediation of basal sediment using land-spreading and slurry-phase bioreactor methods. In: *Proceedings of The Second International Conference on Remediation of Contaminated Sediments*, pp. Paper B-04. Venice, Italy, Battelle Press, Columbus, OH
- Juhasz, A.L., Britz, M.L. and Stanley, G.A. 1996. Degradation of high molecular weight polycyclic aromatic hydrocarbons by *Pseudomonas cepacia*. *Biotechnol. Lett.* 18, 577-582.
- Oil Gator International. 2005. www.oilgator.com. Accessed July 2005.
- Park, K.S., Sims, R.C. and Dupont, R.R. 1990. Transformation of PAHs in soil systems. *J. Environ. Eng.* 116, 632-640.
- Payne, J.R. and Phillips, C.R. 1985. Photochemistry of petroleum in water. *Environ. Sci. Technol.* 19, 569-579.

- Rosenbrock, P., Martens, R., Buscot, F., Zadrazil, F. and Munch, J.C. 1997. Enhancing the mineralisation of [¹⁴C]dibenzo-p-dioxin in three different soils by addition of organic substrate or inoculation with white-rot fungi. *Appl. Microbiol. Biotechnol.* 48, 665-670.
- Sarkar, D., Ferguson, M., Datta, R. and Birnbaum, S. 2005. Bioremediation of petroleum hydrocarbons in contaminated soils: Comparison of biosolids addition, carbon supplementation, and monitored natural attenuation. *Envir. Pollut.* 136, 187-195.
- Stringfellow, W.T. and Aitken, M.D. 1995. Competitive metabolism of naphthalene, methylnaphthalenes and fluorene by phenanthrene-degrading Pseudomonads. *Appl. Environ. Microbiol.* 61, 357-362.
- Sutherland, J.B., Rafii, R., Khan, A.A. and Cerniglia, C.E. 1995. Mechanisms of polycyclic aromatic hydrocarbon degradation. In: *Microbial Transformation and Degradation of Toxic Organic Chemicals*, pp. 296-306. (Young, L.Y. and Cerniglia, C.E., Eds.). New York, Wiley-Liss Inc.
- US EPA (United States Environmental Protection Agency). 1998. n-Hexane extractable material (HEM) for sludge, sediment and solid samples (Method 9071B). www.epa.gov/epaoswer/hazwaste/test/pdfs/9071b.pdf. Accessed 16 July 2005.
- US EPA (United States Environmental Protection Agency). 1999. n-Hexane extractable material (HEM) and silica gel treated n-extractable material (SGT-HEM) by extraction and gravimetry (Method 1664). www.epa.gov/waterscience/methods/16640514.pdf. Accessed
- Walter, U., Beyer, M., Klein, J. and Rehm, H.-J. 1991. Degradation of pyrene by *Rhodococcus* sp. UW1. *Appl. Microbiol. Biotechnol.* 34, 671-676.
- Wild, S.R. and Jones, K.C. 1993. Biological and abiotic losses of polynuclear aromatic hydrocarbons (PAHs) from soils freshly amended with sewage sludge. *Envir. Chem.* 12, 5-12.

Chapter 23

USE OF HIGH CONCENTRATION MAGNESIUM SULFATE SOLUTION TO REMEDIATE PETROLEUM IMPACTED GROUNDWATER

James F. Cuthbertson, P.E.¹, Jeffrey A. Kaestner, P.E.² and Lyle G. Bruce, PhD³

¹Delta Environmental Consultants, Inc., 39810 Grand River Avenue, Suite C-100, Novi, Michigan 48375; ²Delta Environmental Consultants, Inc., 6330 East 75th Street, Suite 176, Indianapolis, Indiana 46250; ³BP Products North America Inc., Remediation Environmental Technology, 28100 Torch Parkway, Warrenville, Illinois 60555

Abstract: Anaerobic degradation is the dominant driving force in natural attenuation of petroleum contamination in the subsurface. The contribution to natural attenuation by electron acceptors other than oxygen, such as nitrate, iron III, manganese IV, sulfate, and even carbon dioxide, has been the subject of considerable research in recent years. Kolhatkar et al. (2000), Wiedemeier et al. (1999), and Wilson et al. (2002) have shown that of these natural anaerobic processes, sulfate reduction accounts for most of the degradation. The use of these alternative electron acceptors has been shown to have many potential advantages over the traditional approach of attempting to add dissolved oxygen to the plume. The case studies presented will demonstrate the benefits of using high concentrations of Magnesium Sulfate solution (>1,000 mg/l) to stimulate the biodegradation of petroleum contaminants in groundwater under field conditions at various sites. Many of these sites have had other technologies applied prior to applications. Graphics depicting the historical concentrations and reduction trends will be provided. In addition to the relatively rapid degradation of petroleum compounds such as benzene, toluene, ethylbenzene and xylenes (BTEX), this technology is quite cost effective in comparison to other currently available remediation techniques. A description of the technology, site selection criteria, dosage determination, and field scale performance results demonstrating contaminant concentration reductions in groundwater of more than 90% within a few months at some sites will be presented. Magnesium Sulfate was selected for use due to availability, low cost, high solubility and the relative safety associated with handling. This technology has advantages over others for many sites where physical limitations (buildings, utilities, etc.) preclude other technologies.

Key words: Groundwater remediation, petroleum, sulfate.

1. INTRODUCTION

The use of natural processes to remediate petroleum impacted groundwater *in-situ* is generally accepted practice. However, the length of time needed to reach regulatory required cleanup criteria is sometimes unsatisfactory. Enhancing natural processes to speed the rate of degradation would be very desirable. Anaerobic degradation is the dominant driving force in natural attenuation of petroleum contamination in the subsurface. The contribution to natural attenuation by electron acceptors other than oxygen, such as nitrate, iron III, manganese IV, sulfate, and even carbon dioxide, has been the subject of considerable research in recent years. Kolhatkar et al. (2000), Wiedemeier et al. (1999), and Wilson et al. (2002) have shown that of these natural anaerobic processes, sulfate reduction accounts for most of the degradation. The addition of these alternative electron acceptors has been shown to have many potential advantages over the traditional approach of attempting to add dissolved oxygen to the plume. Successful applications of relatively low concentrations of sulfate solution (<1,000 milligrams per liter (mg/l)) have been previously reported (Anderson et al., 2000; Cunningham et al., 2001). A process using high concentrations of sulfate solution (>1,000 mg/l) has

been developed to accelerate remediation and site incident closure. The case studies presented in this paper demonstrate the benefits of using high concentrations of Magnesium Sulfate Heptahydrate (MgSO_4) solution to stimulate the biodegradation of petroleum contaminants in groundwater under field conditions at various sites. In addition to the relatively rapid degradation of petroleum compounds such as BTEX, this technology is quite cost effective in comparison to other currently available remediation techniques. Magnesium Sulfate was selected for use due to availability, low cost, high solubility and the relative safety associated with handling. This technology has advantages over others for many sites where physical limitations (buildings, utilities, etc.) preclude other technologies.

2. MATERIALS AND METHODS

2.1 Misconceptions

While advocating this technology at various sites with regulatory agencies in many different states within the USA, we encountered many misconceptions about the technology. The following is a summary of these misconceptions and an explanation of why they are misconceptions.

2.1.1 Misconception # 1: Biodegradation requires aerobic conditions.

While many traditional remediation technologies have focused on increasing the available subsurface oxygen supply to stimulate aerobic degradation, anaerobic conditions exist at the majority of petroleum impacted sites (Chappell, 2000; Wiedemeier et al., 1999). This is because oxygen is quickly depleted on the upgradient side of the plume and indigenous anaerobic bacteria, which are almost universally present in the shallow subsurface (Ghiorse and Wilson, 1988), will bloom in the absence of oxygen. Anaerobic biodegradation has been documented to be the dominant mechanism for natural attenuation at many sites (Kolhatkar et al., 2000).

2.1.2 Misconception # 2: This is in-situ direct oxidation (Persulfate Radical).

This process does not utilize persulfate. The generation of Persulfate Radicals is an entirely unrelated process. The technology presented in this paper is a process to enhance natural biodegradation by replenishing a locally depleted electron acceptor (Sulfate).

2.1.3 Misconception # 3: Anaerobic Biodegradation is too slow to be feasible.

In fact, for the majority of petroleum impacted sites anaerobic biodegradation is the dominant component of natural attenuation whether enhanced or not (Kolhatkar et al., 2000). Monitored Natural Attenuation is an accepted remedial approach by many regulatory agencies within the USA. The process presented in this paper is predicated on the enhancement of this ongoing natural process.

2.1.4 Misconception # 4: Hydrogen Sulfide gas will be generated.

While Sulfide is a byproduct of the reaction, under typical field conditions there are adequate concentrations of dissolved metals, such as Ferric Iron, to bond with the Sulfide. Hydrogen Sulfide gas generation has not been an issue at any of the sites where this technology has been utilized, but if it is a concern it should be monitored.

2.1.5 Misconception # 5: Addition of the application material will result in increased plume migration.

The use of a higher concentration solution results in the application of lower volumes to introduce the desired mass of Sulfate to the contaminant plume. Typical site application volumes are on the order of 500 to 1,000 gallons applied over a period of four to eight hours. Since the typical fluid volume in the target area of the aquifer is greater than 100,000 gallons, the MgSO₄ solution added is less than 1% of the aquifer volume. Post application monitoring performed has not documented contaminant plume migration to previously unimpacted areas on any sites where this technology has been utilized.

2.1.6 Misconception # 6: This technology will result in a lingering sulfate contaminant plume in the groundwater.

The feasibility evaluation process for this technology is intended to assure that favorable conditions exist for the utilization of Sulfates by the existing bacteria population. Applications are made in iterative steps to minimize the potential for applying more Sulfate than is required to adequately degrade the contaminants.

2.2 Technology Description

The material utilized in this process is a custom-blended, aqueous solution of agricultural grade MgSO₄, or simply hydrated magnesium sulfate, which is commonly known as Epsom Salts. Our supplier is Livingston Fluid Services, Inc. of Howell, Michigan. For the case studies discussed in this paper, the solution applied contained a target concentration of approximately three pounds of MgSO₄ per gallon. Analytical testing of several batches of the application material indicates a typical Sulfate concentration of 140,000 mg/l. The use of this relatively high concentration application material minimizes the volume of solution needed to introduce the desired amount of Sulfate to the contaminant plume which reduces potential transportation costs. Another benefit of using a relatively highly concentrated application solution is that less time is required on site to complete the application. The application material was delivered to the case study sites by bulk tanker truck, in steel drums, or in plastic containers.

2.3 Site Selection Criteria

The potential for applicability of this technology at a given site is based on a limited number of readily determined factors. Most important is an evaluation of the concentrations of electron acceptors within and outside of the extent of the contaminant plume. If the electron acceptors within the plume are depleted in comparison to non-impacted background locations, there is a clear indication that the existing bacterial population is capable of degrading the contaminants and the limiting factor is the availability of electron acceptors. Therefore, the addition of sulfates is likely to increase the degradation of contaminants.

In the event that the site contains an appreciable quantity of liquid phase product (LPH), it may be more cost effective and expeditious to initially use other techniques to address the highly impacted source material. Once the majority of the LPH has been removed, sulfate addition may be a cost effective method to address the residual impact.

Sulfate addition may not be suitable as the only remediation technique if site conditions indicate that hydraulic plume control is warranted or if a sensitive receptor, such as a drinking water supply, is immediately threatened.

2.4 Dosage Determination

Site specific dosage is estimated by first calculating the desired volume of impacted groundwater to be treated and then determining the mass of sulfate needed to raise the average concentration within this volume by 250 mg/l. An experience based site specific demand factor of one to five is then used to develop the site specific dosage. The site specific demand factor is based on the relative degree of impact, groundwater flow velocity, results of previous site sulfate applications or pilot studies, proximity of sensitive receptors, and background sulfate concentrations.

2.5 Application Techniques

2.5.1 Surface Applications

Sulfate exists naturally in most groundwater. It is highly soluble compared to other electron acceptors and has a high capacity to reduce contaminant mass. Sulfate is a key factor in the degradation of contaminants in matured plumes. Sulfate is relatively less expensive than other treatment technologies and for select sites may be significantly less costly based on the advantages identified above.

Sulfate can be applied by three primary application methods. Because of this flexibility, it is applicable to a wide range of sites. The three primary application techniques include surface or dry application, application in designated application wells that intersect the target groundwater treatment zone, or liquid application through infiltration trenches that distribute the sulfate over a target area.

Surface, or soil mixing, application can be very effective for select applications. Selected applications where sulfate, supplied as Calcium Sulfate (Gypsum), has been mixed with backfill material, approximately 1% by volume, have been proven to aid in the degradation of residual contamination that may remain at the limits of the excavation. The cost for this material is minimal and the onsite application is simple and does not represent additional hazards to workers. Surface applications have also been performed over vegetated areas where shallow groundwater contamination is targeted. Application via surface application requires a few key site conditions to improve effectiveness. The rate at which the sulfate can reach the contaminant will be dependant on the soil porosity, groundwater movement, and dispersion. In the presence of oxygen, the sulfate reducing microorganisms are less active and there would be an expected delay in the degradation rate of the contaminant. In most cases, this has not been observed to significantly effect the overall time. In all case study sites, degradation under sulfate reduction already appears to be the primary driver and the lag time by introducing oxygen through infiltration of rain or application of backfill material appears limited.

2.5.2 Application Wells

Application of high concentration solution through application wells has been demonstrated to be effective for remediation of dissolved contaminant plumes. Application wells are installed and screened across the target zone. Dose applications can be derived based on the treatment area and mass of contaminate. Premixed solution is delivered to the site and can be directly discharged into the application wells. Application rates will vary depending on the porosity of the soil which directly affects the ability of the well to disperse the solution into the contaminated area. Because this can be a factor on many sites with tight soils, higher concentrations of sulfate solutions are less expensive to apply than would be a more dilute solution. We have observed that it is not practical to field mix these batches to meet selected application rates. The monitoring well network surrounding the application well is a critical component to this type of application. The objective is to apply a sufficient amount of sulfate to be consumed by the degradation of the contaminant while at the same time reducing the amount of introduction water that may have an adverse effect on the plume.

2.5.3 Application Trenches

The third application technique involves the construction of an infiltration trench with a header system to increase the area of the application. A trench backfilled with porous material serves as a below grade engineered distribution system. The granular backfill being more porous than the target soil serves to improve the application rate, reducing the amount of time to introduce the target sulfate addition, and also increase the distribution during the application. Trench dimensions are determined by the estimated amount of individual applications, physical site restrictions, and dimensions of the plume. A header system to distribution piping is typically constructed to aid in uniform distribution in the trench initially but also serves to facilitate targeting areas where additional applications may be required. This approach requires more surface construction than application wells but may ultimately reduce the number of site applications.

3. RESULTS

There are many benefits to providing sulfate as the terminal electron acceptor. As anaerobic conditions naturally prevail under petroleum impacted sites, this technology enhances processes that are already occurring. The high solubility of sulfate provides an engineering option that reduces cost and minimizes hazards. The lower energy reactions also require less nutrient supplementation and produce less secondary precipitates which can be costly to manage. Since one mole of sulfate has twice the oxidizing capacity of oxygen, sulfate is extremely efficient at target area reduction. This is the primary benefit that makes this a cost feasible option.

The injection of $MgSO_4$ is an in-situ remedy which promotes anerobic biostimulation. Biostimulation refers to the manipulation of environmental conditions to enhance and accelerate biological degradation of contaminants through microbial respiratory metabolism. This process occurs through the oxidation of an organic compound, such as petroleum constituents, with the reduction of an inorganic compound (electron acceptor). Aerobic respiration utilizes oxygen as the terminal electron acceptor, while anaerobic respiration utilizes nitrate, sulfate, ferric iron, manganese oxide, and/or carbonate as the terminal electron acceptor. When the availability of these electron acceptors is limited in subsurface conditions and groundwater flow is not effective in replenishing the depleted electron acceptors, providing an additional source is often the most effective form of remediation. The distribution and availability of electron acceptors controls the rate of biodegradation. As mentioned above, these acceptors are depleted at a rate significantly higher than can be naturally replenished.

3.1 Case Studies

3.1.1 Potterville, Michigan

Magnesium sulfate was applied by surface spreading in the vicinity of the former UST cavity and dispenser islands (Figure 1) at a vacant retail gasoline site in Potterville, Michigan. The UST systems were removed from the site in 2001. Confirmed releases were reported in 1992 and 2001. Historically, remediation has been unsuccessfully attempted with the use of various techniques including a High Vacuum Extraction system, monitored natural attenuation (MNA), bioaugmentation, and oxygen diffusion. Approximately 1,200 pounds of magnesium sulfate were applied to the site by surface spreading of dry material during four events which occurred between October 2002 and March 2004. In addition, liquid applications of 525 gallons in July 2004, 501 gallons in August 2004 and 651 gallons in September 2004, were completed.

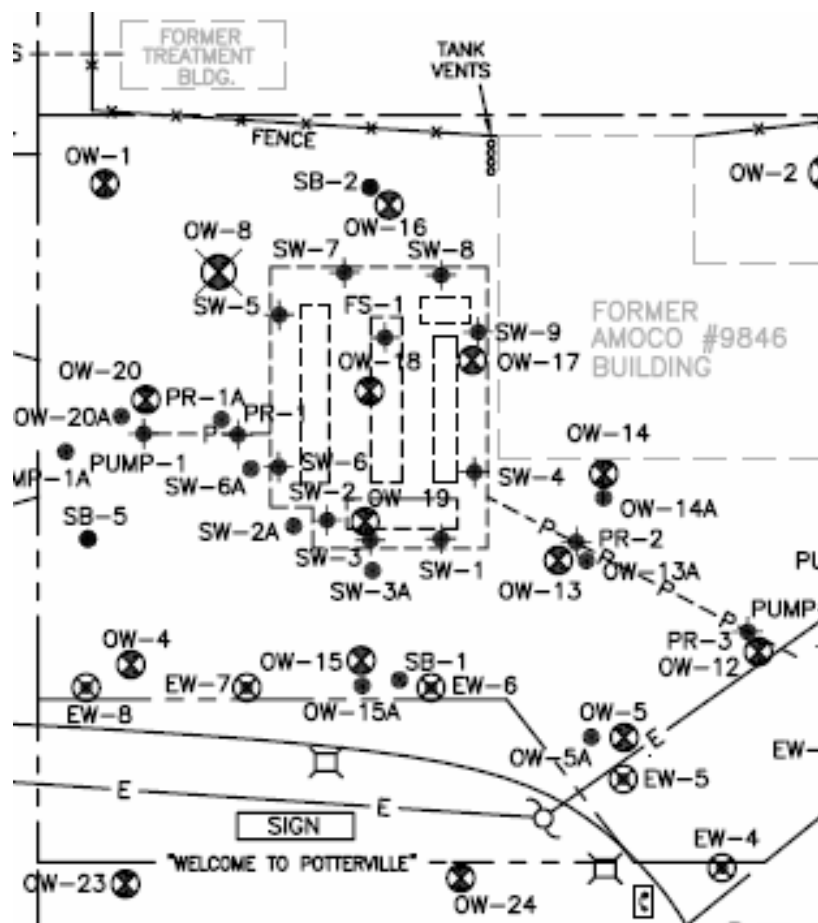

Figure 1. Potterville Site Map

The geological setting at the site is predominately silty clay with granular fill material within the former UST cavity. Groundwater is perched approximately one to two feet below the ground surface. The pavement at the site has been removed. Liquid phase hydrocarbons have been encountered as recently as March 2003.

The following three graphs depict the relatively rapid degradation of the BTEX constituents once the sulfate concentration was enhanced. In all three cases, the toluene concentrations appear to be most rapidly depleted. The graphs also substantiate that the concentrations of contaminants were permanently reduced even after the sulfate concentrations were depleted. Post application monitoring of observation wells surrounding the impacted area did not indicate any migration of the contaminant plume or any increase in sulfate concentrations which further substantiates that the significant reductions in contaminant concentrations are due to degradation and not dilution.

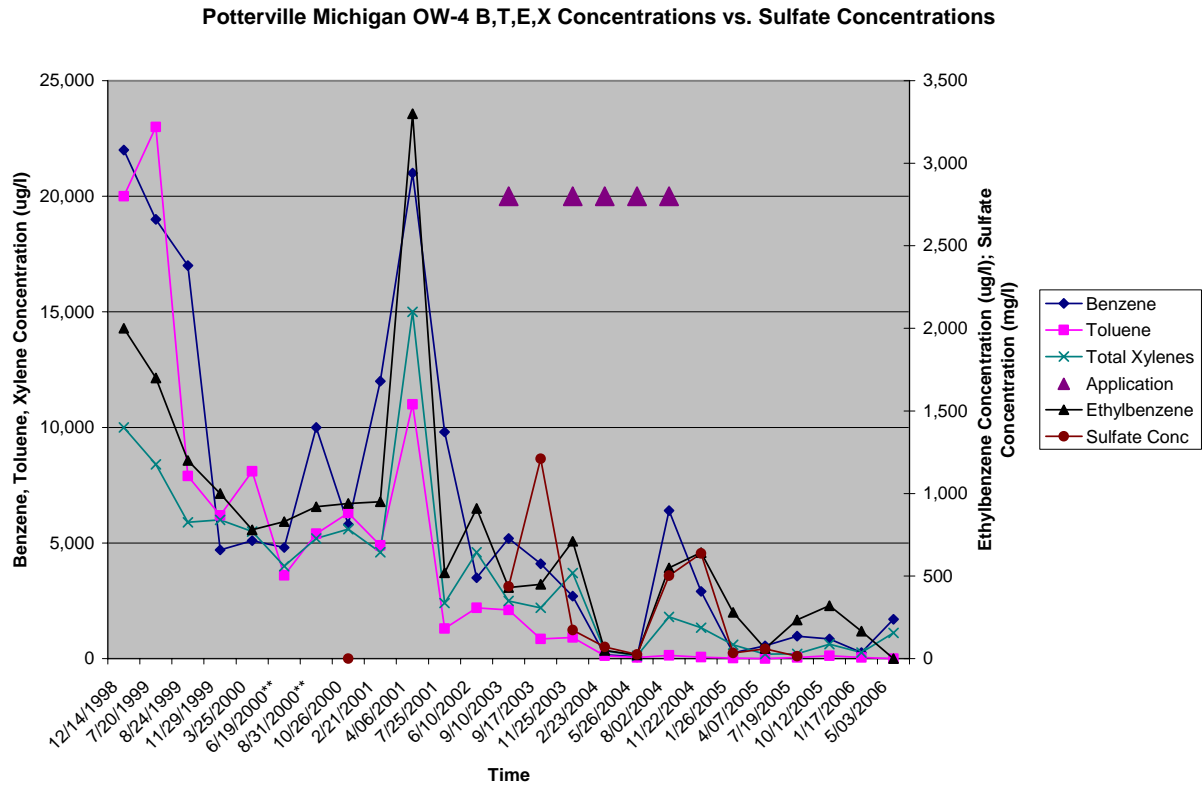

Figure 2. OW-4

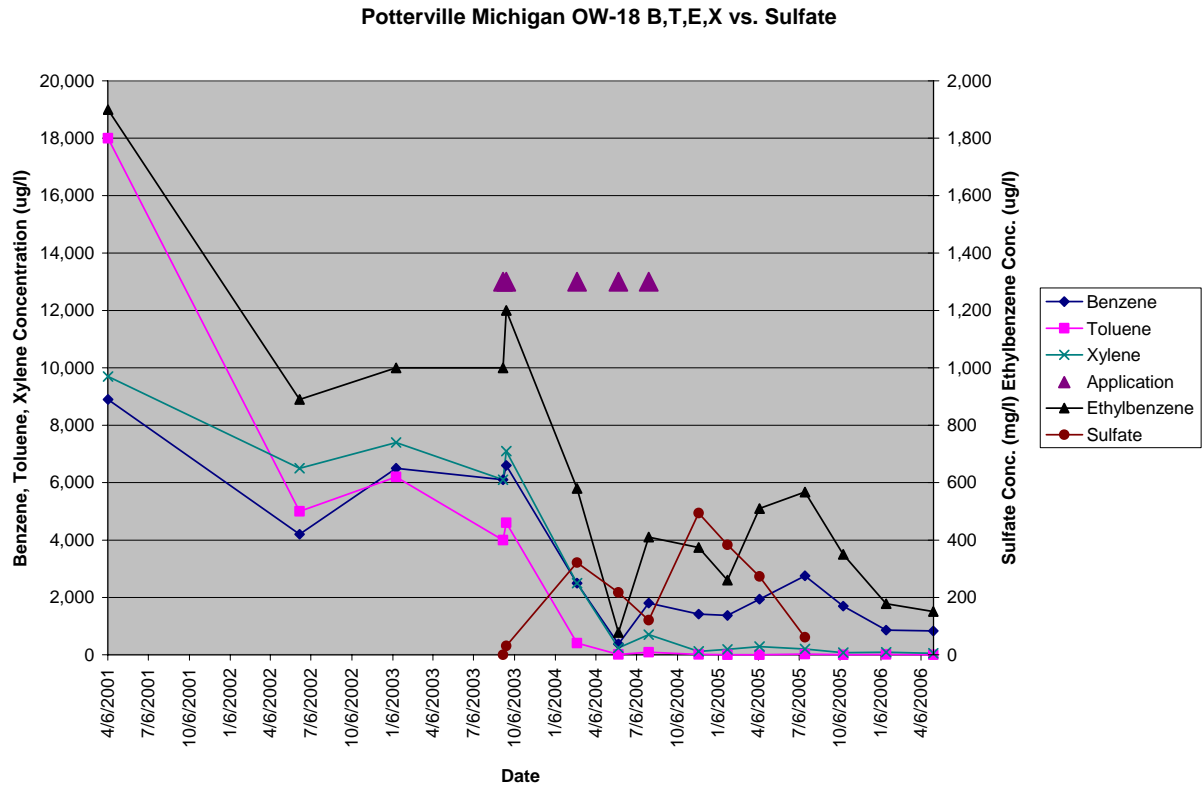

Figure 3. OW-18

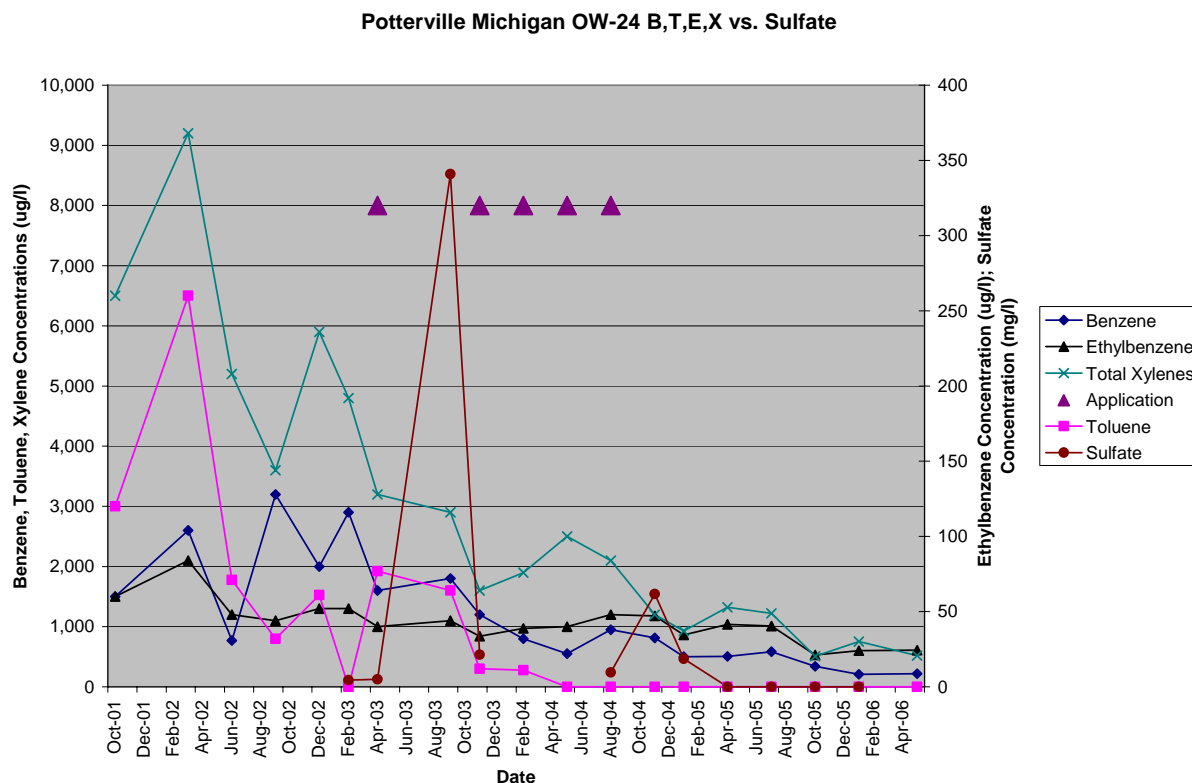

Figure 4. OW-24

3.1.2 Midland, Michigan

Magnesium sulfate was applied to the subsurface by a series of 10 dedicated application wells (Figure 5) at a former retail gasoline site in Midland, Michigan. The site has been developed as a shared parking area for the local municipality and a neighboring church. Confirmed releases were reported in 1988 and 2000. Historically, remediation has been unsuccessfully attempted with the use of various techniques including a groundwater recovery system, monitored natural attenuation (MNA), and bioaugmentation. Four applications were completed as follows: 660 gallons in September 2003; 735 gallons in May 2004; 767 gallons in July 2004; and 527 gallons in September 2004.

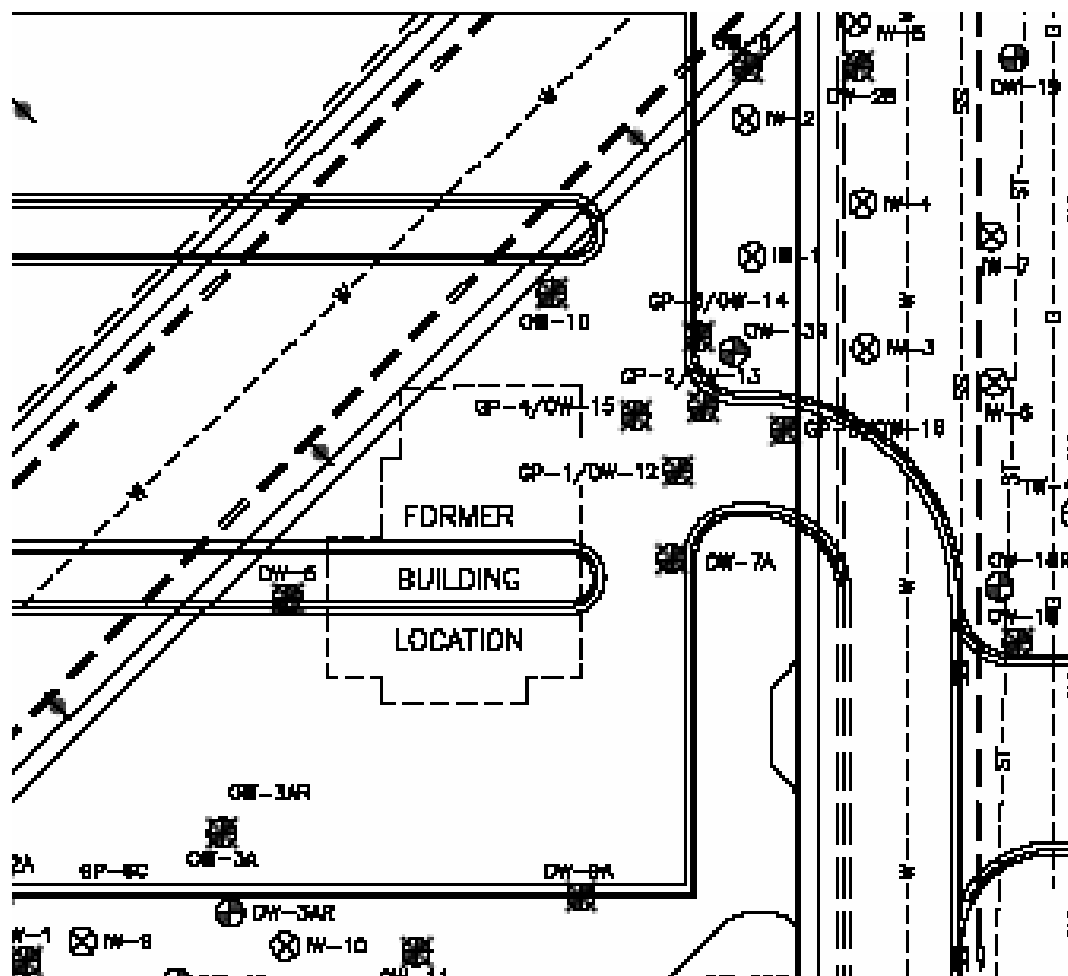

Figure 5. Midland Site Map

The geological setting at the site consists of six to eight feet of predominately fine grained sand overlying clay. Groundwater is perched on top of the underlying clay and is encountered approximately six to eight feet below the ground surface

Similar to the graphs from the other case studies, the following graphs depict the relatively rapid degradation of the BTEX constituents once the sulfate concentration was enhanced. In this case, the concentrations of all of the BTEX constituents have been reduced to near or below the method detection limits. At the OW-3AR location benzene, toluene and xylene concentrations diminished quickly post application. Ethylbenzene degradation proceeded at a slower pace, but eventually degraded as well. Post application monitoring of observation wells surrounding the impacted area did not indicate any migration of the contaminant plume or any increase in sulfate concentrations which further substantiates that the significant reductions in contaminant concentrations are due to degradation and not dilution.

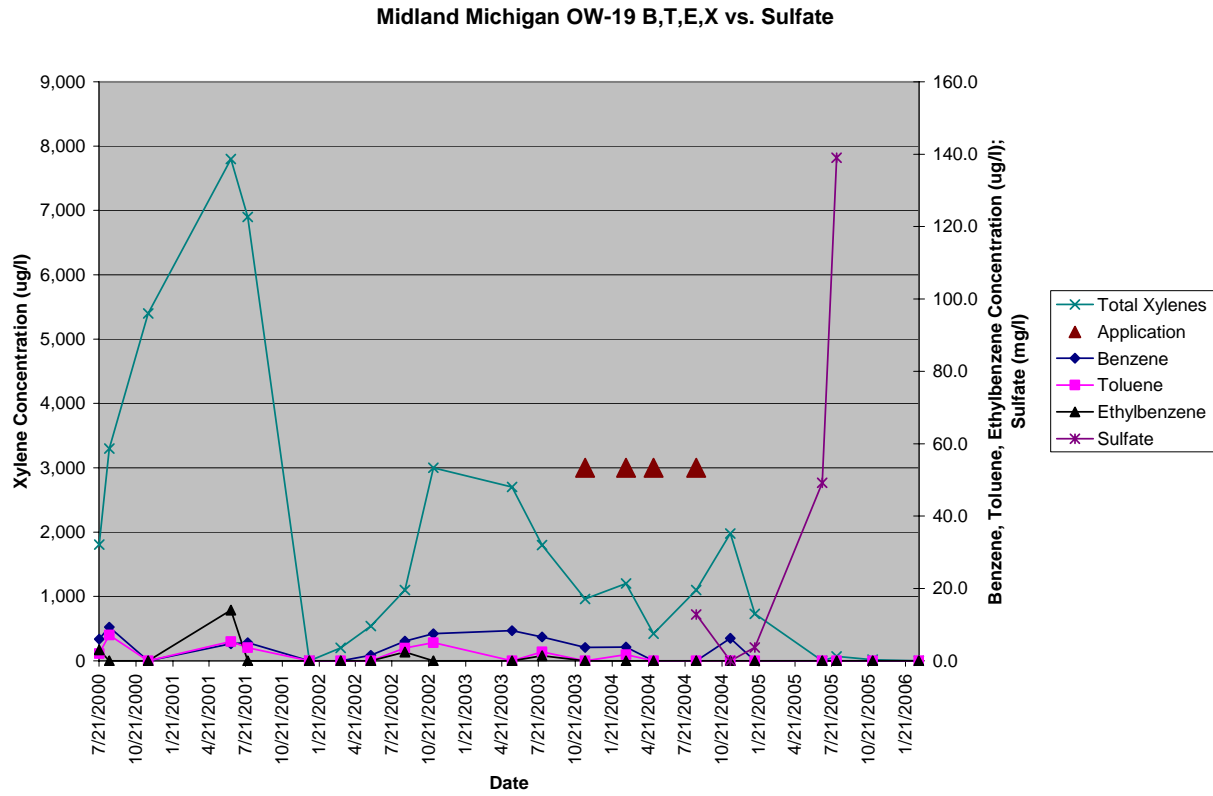

Figure 6. OW-19

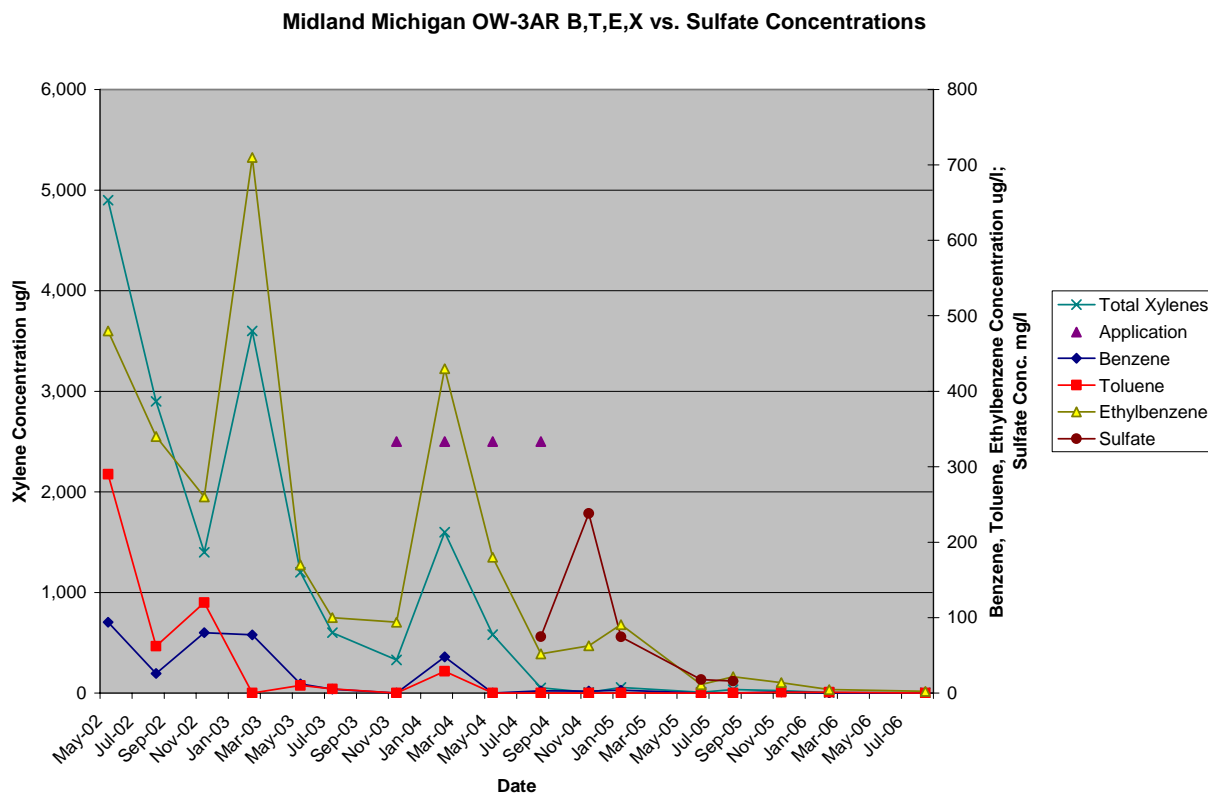

Figure 7. OW-3AR

3.1.3 Indianapolis, Indiana

A magnesium sulfate solution was applied to an infiltration trench system at a former retail gasoline site in Indiana (Figure 8). The site is currently operated as a commercial bank and coffee shop. The trench was installed prior to site construction. This is a historical release site that has had a groundwater recovery system and over excavation activities completed in mid 1990's and early 2000. Three separate applications have been completed including 1,850 gallons in June 2004, 1,860 gallons in July 2004, and 2,500 gallons in October 2004.

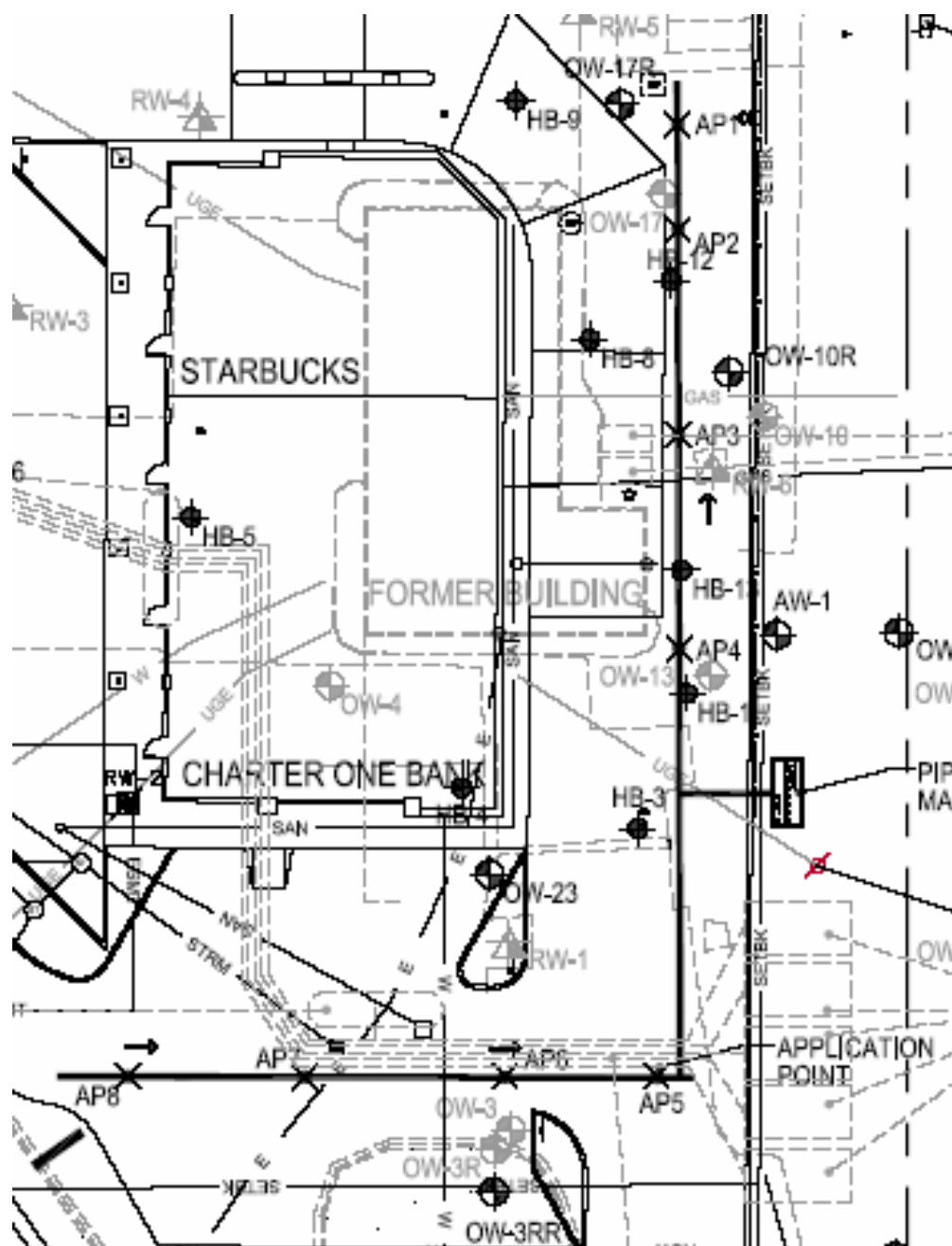

Figure 8. Indianapolis Site Map

Biostimulation through anaerobic respiration was selected to address residual petroleum hydrocarbon impacts that exceeded the approved natural attenuation targets. Access to contaminated areas in shallow groundwater was restricted due to the current use of the property. Other remediation alternatives were evaluated including oxygen enhancements and system installation. The cost of the sulfate applications was approximately half of the modeled oxygen enhancement methods and 1/3 the estimated lifecycle system cost, if site constraints could be eliminated.

Sulfate concentrations were closely monitored in wells within the contaminated area and background wells assumed outside the influence of the release. This was important to understand the rate at which the sulfate was being consumed, to monitor elevated concentration migration and to determine if additional applications were required. Between May 2004 and January 2005, BTEX concentrations were significantly reduced. In many wells, the reduction was greater than 85%, representing a relatively rapid reduction over the affected area. Since January 2005, construction of confirmation wells and additional sampling have demonstrated that concentrations have been

remediated to a level that is consistent with MNA as a final remedial option. These levels were not reached through previous source area excavation and operation of a remediation system at this site.

Site information was collected to demonstrate that the addition of sulfate solution did not dilute or push the contaminant plume. Groundwater sample results as reported by the laboratory indicated that sulfate did influence the target application area and that BTEX concentrations during that same time were not being spread. Water levels in monitoring wells were studied to support the idea that the application was not flushing the contaminant plume. The total volume of solution represents about 9% of the assumed saturated volume in the aquifer, or about 1.5 inches of rain recharging the aquifer based on the impervious surface area available. This site receives approximately 40 inches of rain each year and prior to application the plume was demonstrated to be stable.

The following graphs demonstrate the reduction in contaminate levels at this site.

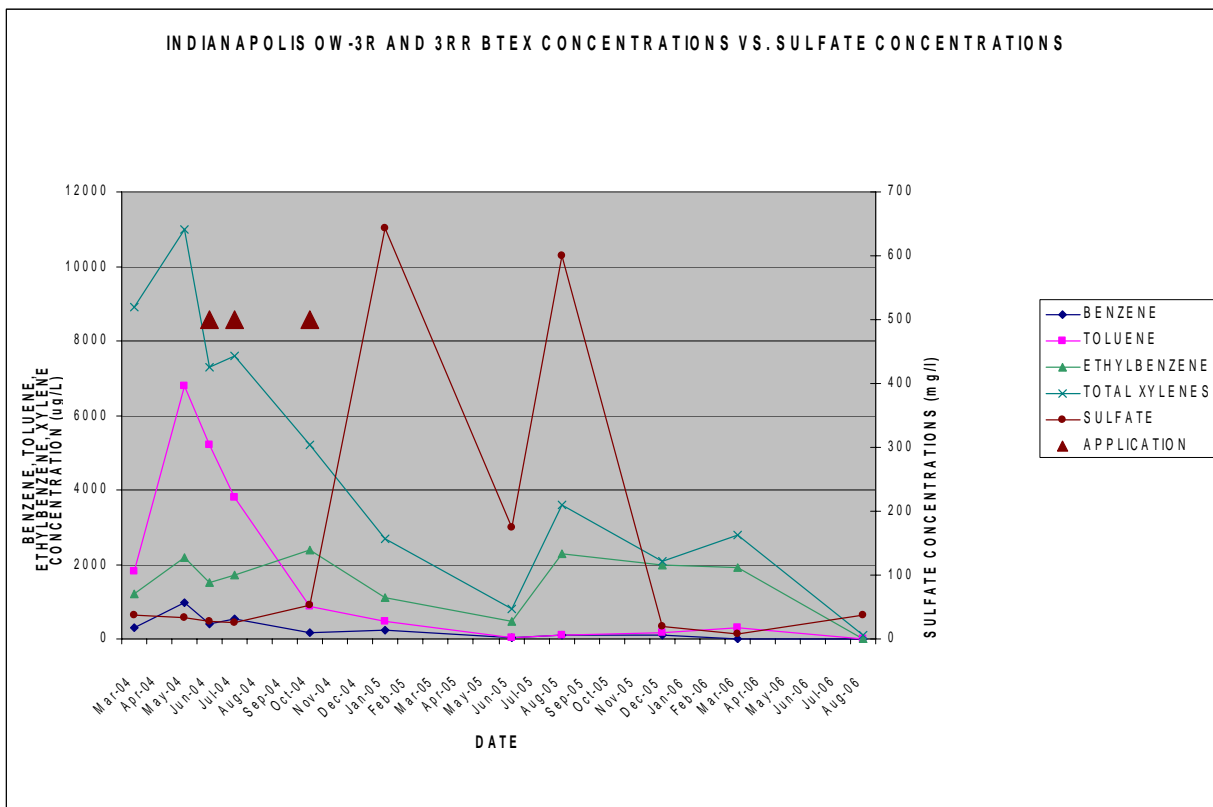

Figure 9. OW-3RR

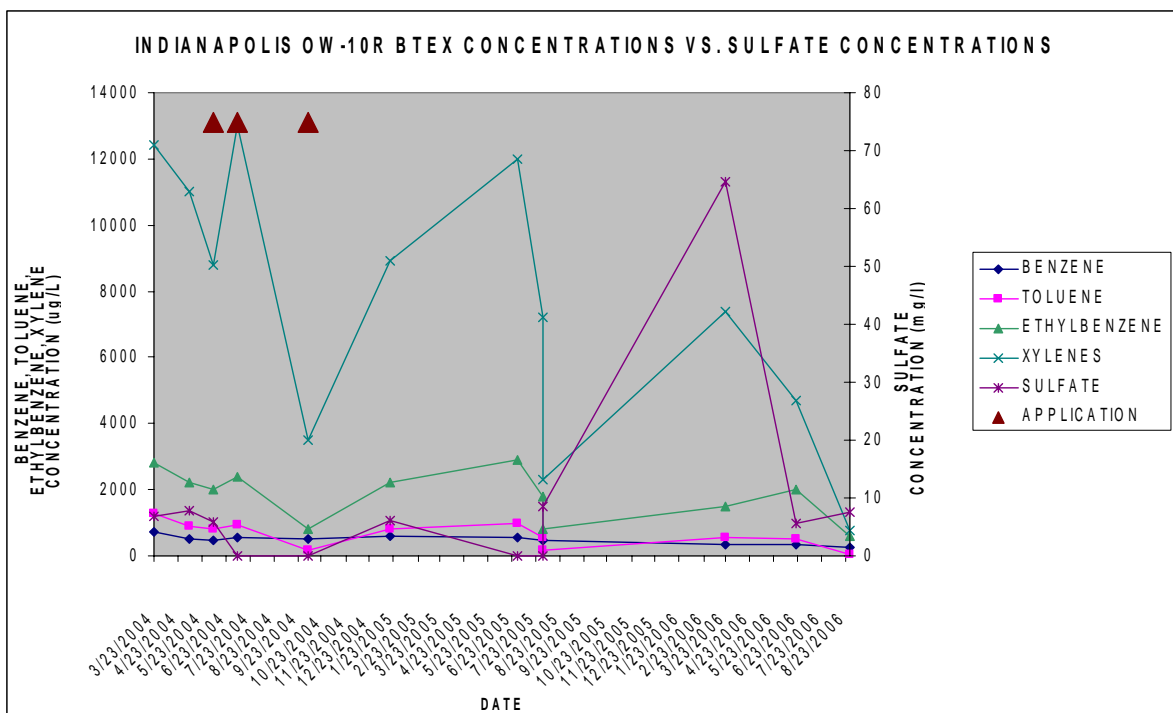

Figure 10. OW-10R

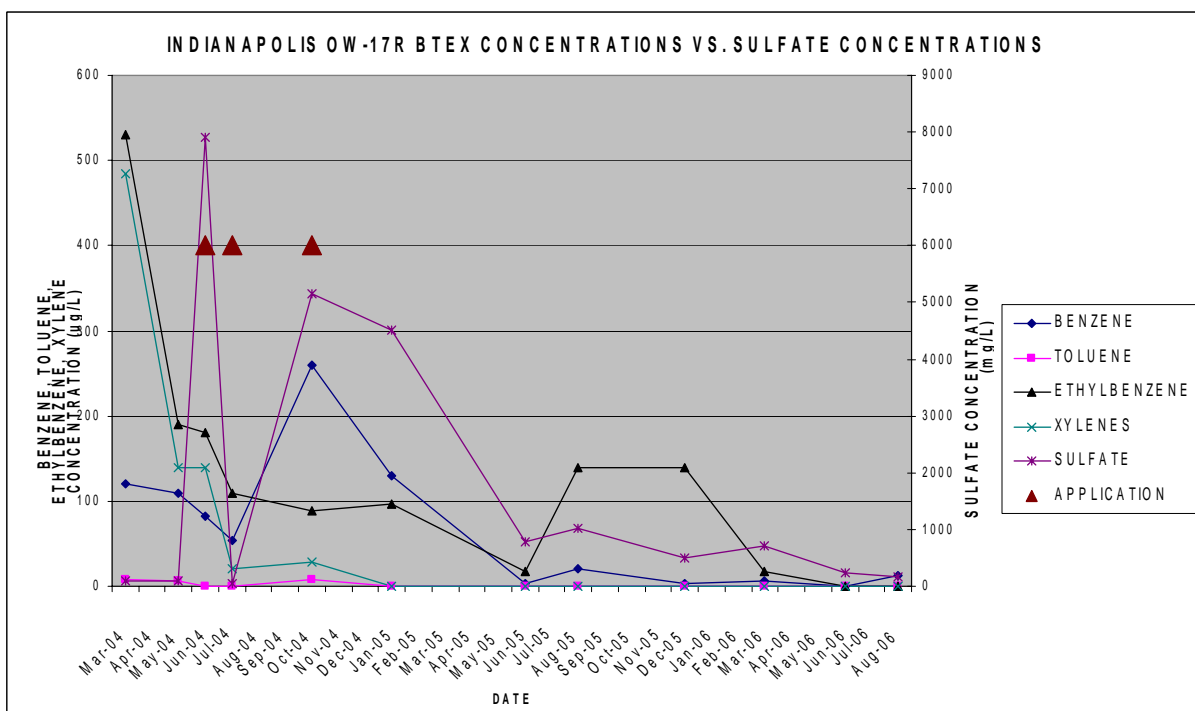

Figure 11. OW-17R

3.1.4 Illinois Pilot Study

A multi-site pilot study has been initiated in cooperation with the Illinois Environmental Protection Agency. Three of the sites included in the pilot study are Rantoul, Antioch and Springfield, Illinois. All three of these sites are retail gasoline stations with historical confirmed

releases of gasoline. Geology at each site consists predominately of silty clay. Horizontal trenches were installed at each site to facilitate the distribution of sulfate solution. At the Rantoul site, 4,920 gallons of solution were applied in July 2005. Two applications were made at the Springfield site, 1,721 gallons in July 2005 and 2,723 gallons in October 2005. In November 2005, 4,920 gallons of solution were applied at the Antioch site.

The following graphs (Bruce and Kolhatkar, 2006) compare the attenuation rates before and after sulfate application. At the Antioch and Springfield sites, the addition of sulfate enhanced biodegradation of benzene, toluene and xylenes during the post application monitoring period. The toluene degradation rate was significantly increased at the Rantoul site.

Antioch, Illinois – MW-8 :BTEX Attenuation Rates Before and After Sulfate Addition

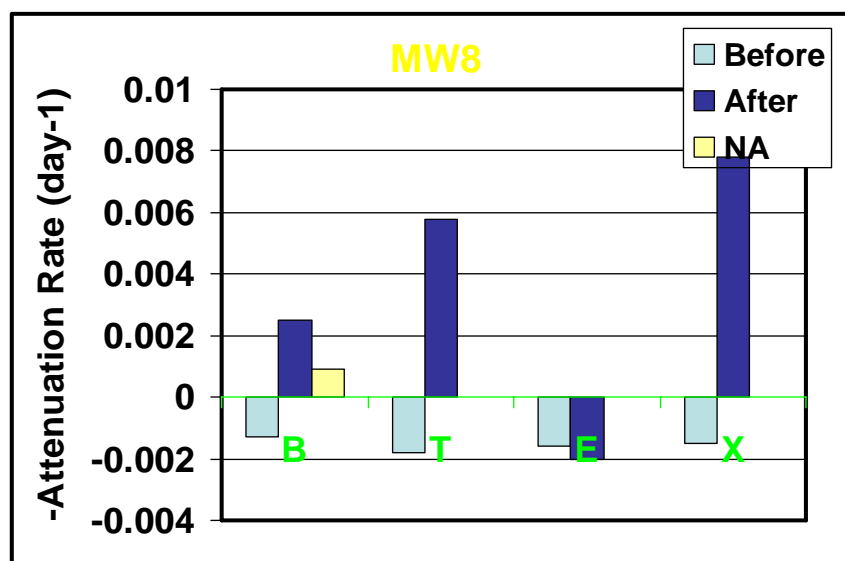

■ Note, the “NA” rate in this graph is an average from published data.

Figure 12. MW-8

Rantoul, Illinois – MW-1 and MW-11
 Attenuation Constants
 Before and After Sulfate Application

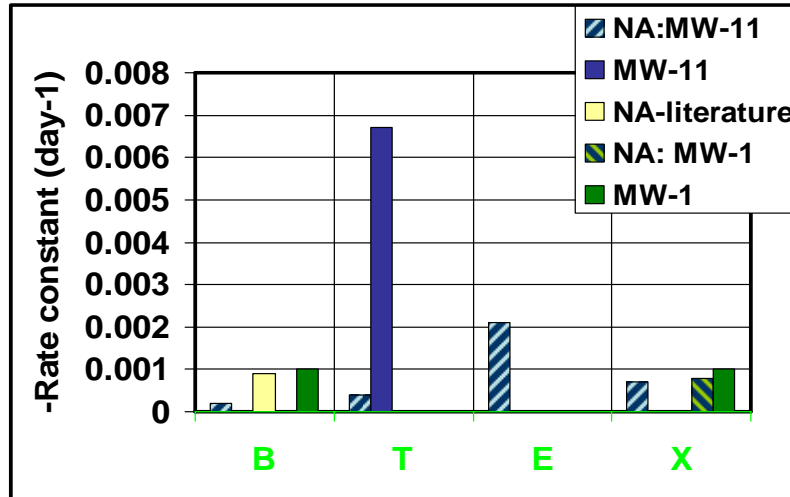

Figure 13. MW-1 and MW-11

Springfield, Illinois BTEX Attenuation Constant (day⁻¹)
After Sulfate Addition

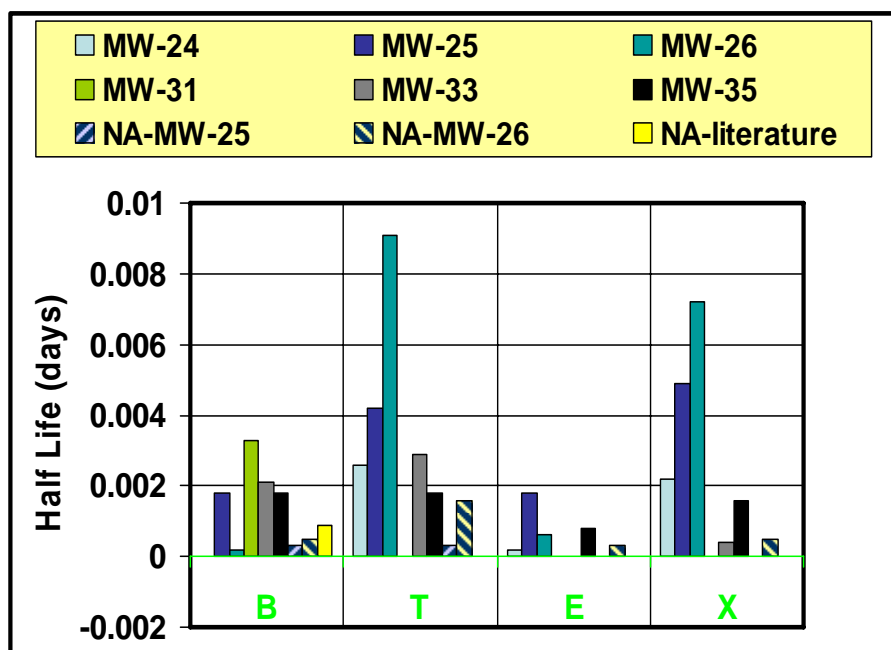

Figure 14. After Sulfate Addition

3.1.5 New York Pilot Studies

A pilot study was conducted on a former retail gasoline station located in New York State from March 2006 to June 2006. Approximately 200 gallons of sulfate solution was applied through an application well during March 2006 and post application monitoring was conducted on a monthly basis for three months from surrounding wells. The following graph represents the data collected from observation well PT-4 which was located approximately 15 feet downgradient of the application well. The monitoring data indicates a reduction in each of the BTEX constituents, but the most significant reductions were noted in the Toluene and Xylene concentrations. While significant reductions in contaminant concentrations were noted, little change in sulfate concentrations was observed which is believed to be indicative of the utilization of the added sulfates prior to dispersion to the PT-4 location. Evaluation of the Pilot Study results was utilized to design a full scale remediation plan and to refine the site specific demand factor.

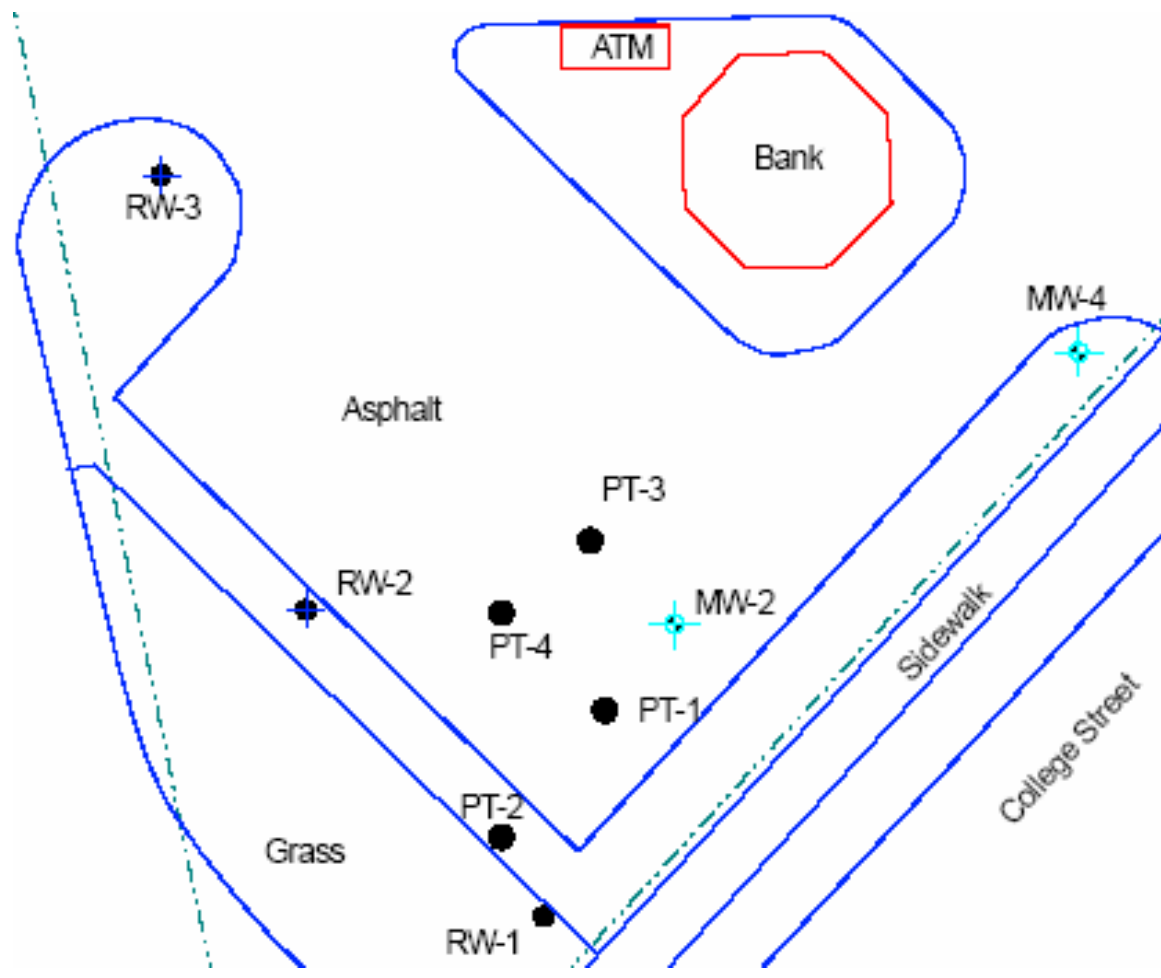

Figure 15. Clinton Site Map

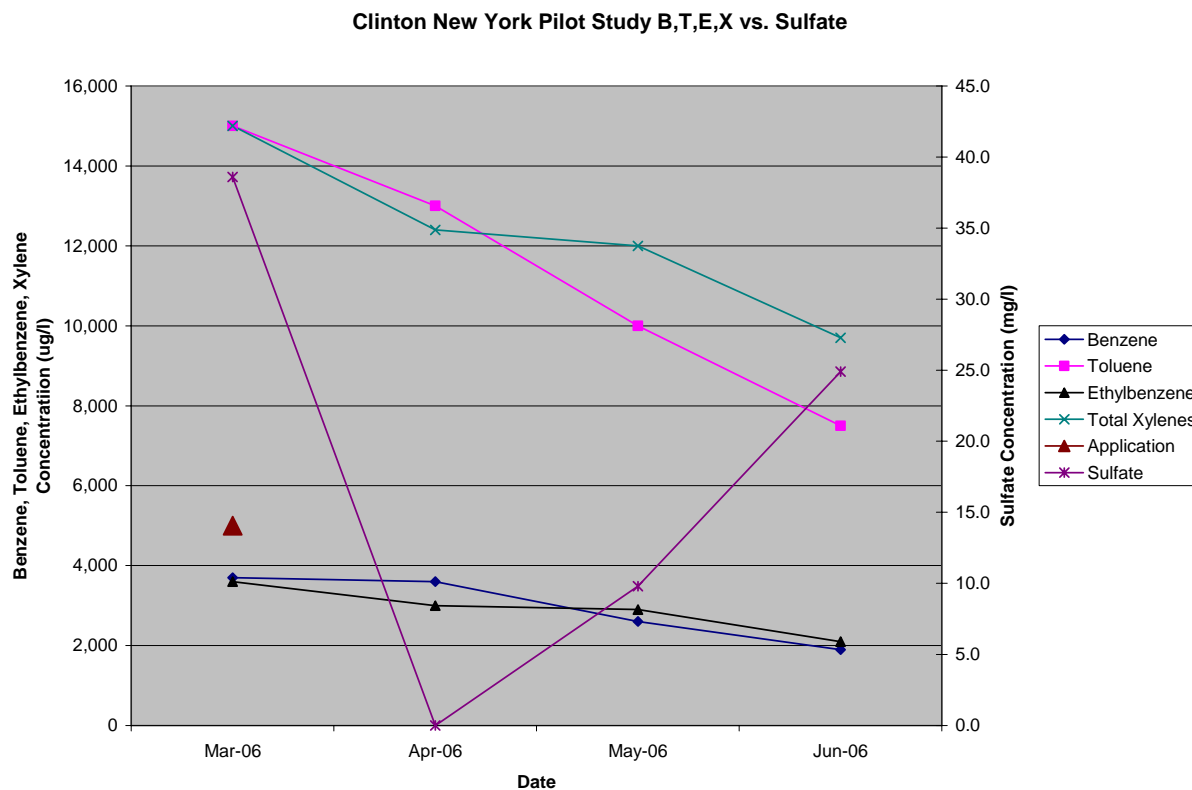

Figure 16. PT-4

4. DISCUSSION

Enhancement of biodegradation with the addition of sulfates is an exciting new option to safely, inexpensively and aggressively remediate petroleum impacted groundwater. Most historical release sites are already in an anaerobic reduction phase and are limited primarily by the lack of sulfate. The microorganisms are acclimated to this environment and the response has been quick on the pilot sites.

The case studies clearly demonstrate that enhancement of the sulfate concentrations results in rapid decreases in BTEX concentrations. These sites were carefully selected and have geologies that promote the efficient application of the solution. Monitoring demonstrated that the contaminant plume was not simply diluted or displaced. Degradation was observed in the expected order, starting with the heavier end hydrocarbons. Sulfate concentrations were observed to be depleted and based on application calculations were consumed within the plume.

Utilization of a concentrated, aqueous solution of sulfate facilitates the distribution of this electron acceptor to the impacted aquifer with a variety of delivery techniques. Site geology is an important consideration in selecting any remedial alternative. Pre- and post-application monitoring is important to understand the application rates and as indicated in the pilot sites may be the most important variable in understanding the rate of reduction.

Toluene and xylene appear to be the easiest to degrade, but the case studies demonstrate that treatment to stringent standards is possible for all of the BTEX constituents.

5. CONCLUSION

When applied appropriately, the addition of sulfate to stimulate existing anaerobic bacteria can be a very effective remediation technique. This approach to site remediation involves the installation of

a minimum of site infrastructure and avoids the typical pitfalls associated with ongoing operation and maintenance of mechanical remediation systems. While some of the BTEX compounds are preferentially degraded in the presence of sulfates, it appears that all are amenable to treatment with this technique and remediation to regulatory standards is achievable. The results demonstrated using this technology show great promise in expeditiously and cost-effectively remediating petroleum contaminant plumes.

REFERENCES

- Chapelle, Francis H., 2001, *Ground-Water Microbiology and Geochemistry*. John Wiley & sons, New York, 477 pages.
- Ghiorse, W. C. and J. L. Wilson, 1988, *Microbial Ecology of the Terrestrial Subsurface*, *Advances in Applied Microbiology* 33:107-172.
- Kolhatkar, R., Wilson, J. T. and Dunlap, L.E., 2000, Evaluating Natural Biodegradation of MTBE at multiple UST sites, *NGWA/API Petroleum Hydrocarbons & Organic Chemicals in Groundwater*. API p. 32-49.
- Wilson, John T., and Ravi Kolhatkar. (2002). Role of Natural Attenuation in the Life Cycle of MTBE Plumes. *Journal of Environmental Engineering*, Volume 128(9):876-882.
- Ravi Kolhatkar, Tomasz Kuder, Paul Philp, Jon Allen, and John T. Wilson. (2002) Use of Compound-Specific Stable Carbon Isotope Analyses to Demonstrate Anaerobic Biodegradation of MTBE in Groundwater at Gasoline Release Site. *Environmental Science & Technology* 26(24):5139-5146 (2002).
- T. Kuder, R. P. Philp, R. Kolhatkar, J. T. Wilson and J. Allen. (2002) Application of Stable Carbon and Hydrogen Isotopic Techniques for Monitoring Biodegradation of MTBE in the Field. *Proceedings of the 2002 Petroleum Hydrocarbons and Organic Chemicals in Ground Water: Prevention, Assessment, and Remediation, Conference and Exposition, November 6-8, Atlanta Georgia*, pages 371 to 381. (2002).
- Weiner, J. M.; Lauck, T. S.; Lovley, D. R., *Bioremediation Journal* 1998, 2, 159-173 Enhanced Anaerobic Benzene Degradation with the Addition of Sulfate.
- Jonathan M. Weiner, Terry S. Lauck, and Derek R. Lovley (2000); Enhanced Anaerobic Benzene Degradation with the Addition of Sulfate, *Environmental Science & Technology* 2000, 34, 2261-2266.

Chapter 24

TECHNICAL CHALLENGES ON THE MARINE HYDRAULIC DREDGING PROJECT, NEW BEDFORD HARBOR SUPERFUND SITE

Kenneth C. Gaynor¹, Caroline S. Roberts¹, Carl L. Wilson¹, Steven Fox¹, and Terence P. Driscoll²
¹Jacobs Engineering Group, Inc.; ²Sevenson Environmental Services, Inc.

Abstract: Jacobs Engineering Group, Inc. (Jacobs) and Sevenson Environmental Services, Inc. (Sevenson) are conducting remedial activities at the New Bedford Harbor Superfund Site (Site) under contract with the US Army Corps of Engineers (USACE). Funding and oversight for this project is provided by the US Environmental Protection Agency (EPA) through the national Superfund Program. The Site is located in Bristol County, Massachusetts, approximately 55 miles south of Boston. Contamination at the Site consists of marine sediments impacted by polychlorinated biphenyls (PCBs) and heavy metals from industrial activities adjacent to the shoreline.

The selected remedial alternative for the Site involves hydraulic dredging for removal of the PCB-impacted sediment. Following removal, the remedy includes sand separation, sediment dewatering, wastewater treatment, and sediment transportation to an off-site disposal facility.

In 2004 and 2005, the Team (Jacobs, Sevenson, USACE and EPA) solved a number of technical challenges related to dredging in this unique marine setting. Upon initiation of dredging in 2004, hydrogen sulfide (H₂S) gas at concentrations exceeding OSHA's current permissible exposure levels, was immediately released from the marine sediments into an enclosed treatment facility. The elevated H₂S concentrations were mitigated through engineering controls consisting of chemical treatment and local exhaust ventilation to carbon treatment. Ferric sulfate (Fe₂(SO₄)₃) was injected into the dredge slurry to reduce or eliminate H₂S by precipitating ferric sulfide (FeS). A high volume air extraction system was installed to capture any unreacted H₂S. A second challenge involved maintaining the required dredge production despite the presence of debris embedded in the sediment. To overcome this challenge, unique equipment was designed to remove the debris while maintaining the low water column turbidity thresholds established for environmental protection. A third challenge presented to the Team was the accurate monitoring of the vertical and horizontal progress of the dredging in the shallow tidal marine setting. This was accomplished by using a combination of tools, including a Global Positioning System (GPS), laser level soundings, and acoustic bathymetric surveys.

Resolving these technical challenges allowed the Team to reduce the risk of personal injury and increase overall productivity. The lessons learned on the New Bedford dredging program can be applied to other freshwater and marine dredging environments where success is measured not only in sediment removal rates per day, but in worker safety metrics and process quality control.

Key words: marine; marine hydraulic dredging; PCB; hydrogen sulfide; H₂S, safety; debris removal; bathymetry.

1. INTRODUCTION

From the 1940s into the 1970s, electrical capacitor manufacturing plants in the New Bedford area discharged PCB waste either directly into the Harbor or indirectly through discharges to the City of New Bedford's sewer system. In the mid-1970s, as a result of EPA investigative sampling,

polychlorinated biphenyl (PCB) contaminants were identified in the sediments and the seafood in the New Bedford Harbor area. In 1979, the Massachusetts Department of Public Health issued regulations prohibiting fishing and lobstering throughout the Site due to high levels of PCB contamination, ranging to higher than 100,000 parts per million (ppm) in various parts of the Harbor. The Site was included on the Superfund National Priorities List (NPL) in September 1983. EPA's site-specific investigations were initiated in 1983-1984, and included engineering feasibility studies of alternative dredging methods and disposal of contaminated sediments, pilot dredging and disposal studies to field test different dredging and disposal technologies for the contaminated sediments, and extensive physical and chemical computer modeling of the Site. These studies are summarized in more detail in EPA's Administrative Record of Decision (ROD) for the Site.

In September 1998, after years of study, public debate, and consensus building, EPA selected a cleanup remedy for the entire Upper and Lower Harbor areas as a solution to the widespread PCB contamination in and around New Bedford Harbor. The remedy involved the dredging of about 170 acres and containment of approximately 450,000 cubic yards (cy) of PCB-contaminated sediment in confined disposal facilities (CDFs).

The ROD, issued by EPA in September 1998, described the following three principal goals for the project:

1. The reduction of health risks due to consumption of PCB-contaminated local seafood;
2. The reduction of health risks due to contact with PCB-contaminated shoreline sediments; and
3. The improvement of water quality in the highly distressed marine ecosystem in the Harbor.

Based upon additional sampling events since the original ROD was signed, the estimate of quantities of material requiring dredging and disposal has increased 95 percent to approximately 880,000 cy. In addition to concerns from neighboring businesses and residences regarding the practical implementation of CDFs, these factors led the EPA to reconsider off-site disposal for the remaining contaminated material, rather than further construction of CDFs. The EPA documented the decision to use off-site disposal rather than construct CDFs in an Explanation of Significant Difference (ESD) document dated February 2002.

To satisfy the goal of the ROD, sediment removal is required if the concentration of total PCBs exceeds the limits specified for designated areas within the New Bedford Harbor. The total PCB value is defined as the sum of PCB homologue groups. Harbor sediments that exceed the PCB levels specified in the EPA ROD (between 1 to 50 ppm, depending on exposure risk established by the EPA) will be removed from the Harbor and processed through desanding, dewatering, and wastewater treatment equipment. Contaminated oversize material, sand, and filter cake (silt) will be transported off-site for landfilling.

2. HARBOR DREDGING EQUIPMENT AND MATERIALS

The processing equipment in use on the project was designed and installed by the Jacobs Engineering and Severson Environmental project team. Much of the equipment in use was already owned by Severson, and therefore was readily available for use on the New Bedford project. In many instances, long lead times for equipment design and manufacture were avoided, allowing the Jacobs/Severson team to mobilize and set up the treatment process train quickly and efficiently. The major equipment systems in use on the project are briefly described in this section.

2.1 Dredges

The Jacobs/Severson team recommended hydraulic dredging with a rotary auger as the method to remove sediment from the New Bedford Harbor. This method was subsequently accepted by the EPA and USACE. Hydraulic dredging was selected for the following reasons:

- Hydraulic dredging at this Site is believed to be more cost-efficient than mechanical methods;
- An Ellicott Mud Cat™ hydraulic dredge draws 18 to 30 inches of water, which facilitates dredging within shallower intertidal areas;
- Hydraulic dredging is an efficient and relatively clean method of pumping sediment material onshore;
- Hydraulic dredging provides a uniform removal of material at predetermined cut depth elevations.

The dredge equipment selected for use at the Site was the Mud Cat™ Model MC 2000 type, manufactured by Ellicott, a division of Baltimore Dredges, LLC. To make effective use of tidal conditions, two dredges are used, one within the intertidal zone and the second within the subtidal zone. The pump on each dredge can deliver 1,500 to 3,000 gallons per minute (gpm) of slurry with a solids content of up to 20 percent. One dredge operates at a time, providing a constant flow of dredge material for the solids separation systems downstream (desanding and dewatering) to operate uninterrupted.

2.2 Pipeline and Booster Pump Stations

The two dredges operate in different dredge management units (DMU) in the harbor, but are in close proximity to each other. In general, the dredges are positioned so that at least one dredge can operate during low tide conditions. A 10-inch high-density polyethylene (HDPE) pipeline connected from each dredge carries the slurried sediment to a diesel booster pump. The booster pump maintains the proper flows in the pipeline to convey the sediment 5,500 feet to the desanding operation. Each pipeline is sized to maintain sufficient velocity (7-10 feet/second) within the pipe to avoid settling of the dredged material in the pipeline.

The pipes convey the sediment load to the desanding operations set up at the EPA/USACE property adjacent to the harbor (known as Area C). After desanding, the sediment slurry is pumped through a 12-inch diameter, double walled HDPE pipeline to the dewatering process and wastewater treatment system at another EPA/USACE facility along the shore of the harbor (Area D). The Area D dewatering facility is approximately 7,000 feet south of the Area C desanding facility (see Figure 1).

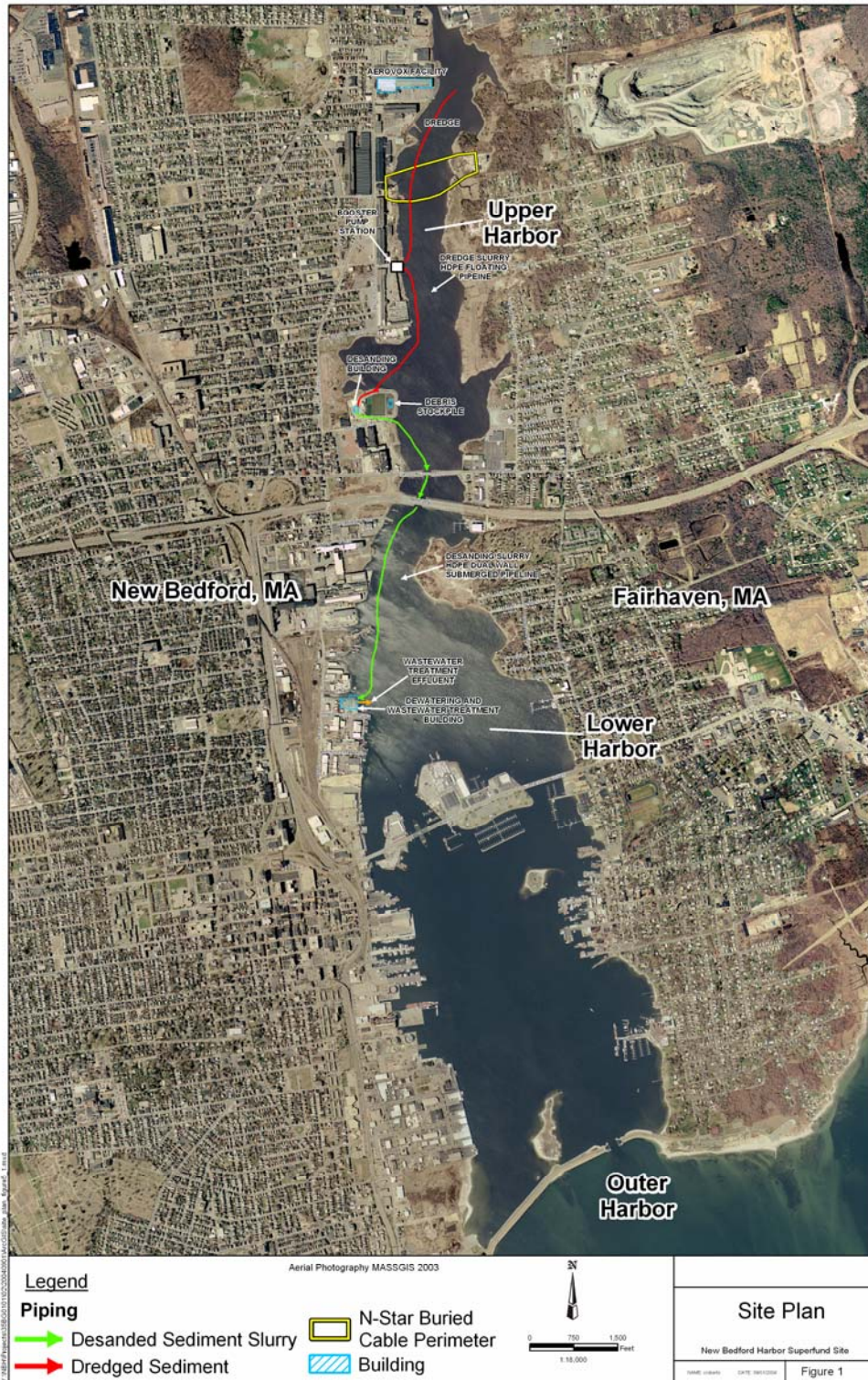

Figure 1. Site Plan

2.3 Desanding Equipment

The desanding equipment consists of:

- Dual, high G-force, linear-motion, vibrating shaker screens to remove oversized materials;
- Hydrocyclones suspended over high G-force, fine screen shakers to remove the sand fraction;
- A V-bottom desanding tank; and
- Diesel transfer pumps to transport the desanded slurry to the dewatering system.

The dredging operation generates slurry at a rate of 1,500 to 3,000 gpm. On average, the slurry contains approximately 8-15 percent solids by weight. The dredged slurry is first pumped through a coarse vibrating shaker screen with 2-inch mesh screens to remove the over-sized material. The screens remove debris, stones, shellfish, large wood chips, and some gravel from the slurry. Screened material is discharged onto a contained pad and stored within the desanding building at Area C pending analysis and off-site disposal. The screened slurry is gravity-fed into V-bottom tanks where it is then pumped through desander units.

Each desander unit consists of three, 10-inch diameter hydrocyclones mounted over fine shaker screens. The desanding operation removes approximately 15 to 50 percent of the total solids in the dredge slurry, depending upon the feed material from the dredge. In general, the resulting slurry solids content to the filter press operation is 8 to 12 percent (by weight).

The underflow from the hydrocyclones is directed over dual, vibrating linear motion shakers with 200-mesh (74 microns) screens for sand removal. As with the coarser screened material, this sand fraction is temporarily stored within the desanding building, pending analysis for PCBs and off-site disposal. The overflow from the desanders is collected in a 20,000-gallon, agitated pump tank, and is pumped to the dewatering system at Area D. The dredge, booster pumps, and desanding equipment design layout is shown in the Area C process flow diagram (see Figure 2). A mass balance for the dredging, desanding, and dewatering processes 2006 remediation season is shown in Figure 3.

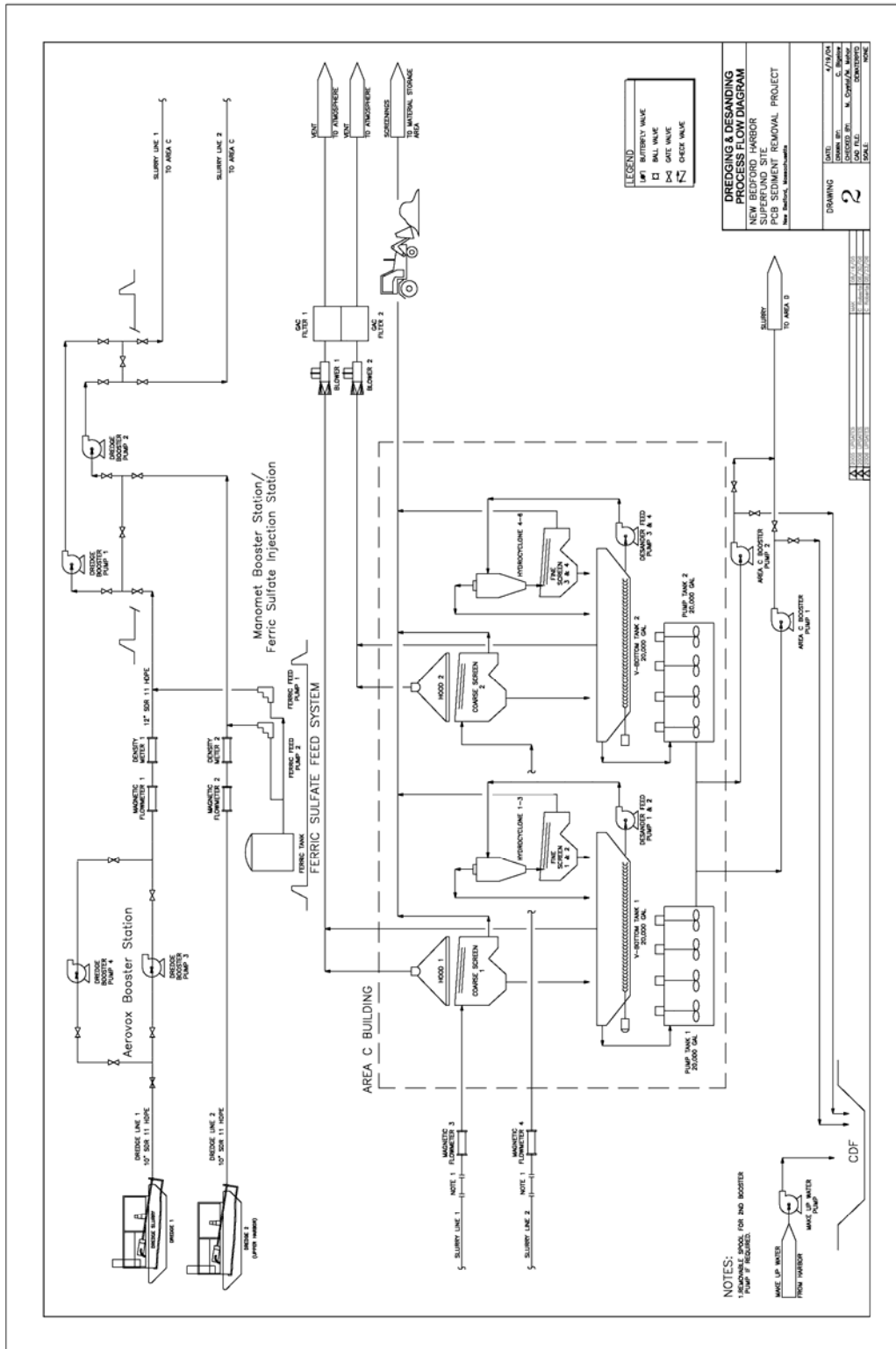

Figure 2. Dredging & Desanding Process Flow Diagram

Sediment Processing Using De-sanders Followed By Filter Presses
 Severson Environmental Services, Inc

Project Name: New Bedford Harbor Superfund Site
 Date: 4/11/2006
 Revision: 1

| Insitu Material | |
|-------------------------------------|-----------------------|
| Volume, cubic yards | 20,000 |
| Oven Dry Solids, % | 44% |
| Specific Gravity | 1.350 |
| Density, tons per cubic yard | 1.13 |
| Silt and Finer Mass, % dry weight | 76.00% |
| Sand and Coarser Mass, % dry weight | 24.00% |
| | Plus 20% Sand |
| | Assume 80% Efficiency |

| Filter Press Inputs | |
|--------------------------------------|--------|
| Silt and Finer Mass, Dry tons | 7,584 |
| Cake Oven Dry Solids, % | 60.00% |
| Cake Density, tons per cubic yard | 1.34 |
| Cycle Time, minutes | 130 |
| Oh-Line Factor, % | 85% |
| Press Size, cubic feet per drop | 219 |
| Number of Presses | 6 |
| Feed Oven Dry Solids, % | 4.80% |
| Available Operating Hours, hours/day | 12 |
| Available Operating Days, days/week | 5 |
| Dry Additives, lbs per gallon | 0 |
| Filtrate Solids, ppm | 50 |

| Process Calculations | |
|---|------------|
| De-sander Material Removal, dry tons | 2,395 |
| Gravity Drained Sand Dry Solids, % | 80% |
| De-sander Material Removal, wet tons | 2,994 |
| Filter Cake Production, total wet tons | 12,640 |
| Filter Cake Production, tons/operating day | 307 |
| Operating Days, days | 41 |
| Job Production Duration, weeks | 8.23 |
| Filtrate+Drain Water Prod, gallons per day | 1,120,366 |
| Filtrate+Drain Water Production total gallons | 46,106,935 |
| Average Filtrate+Drain Water Prod (gpm) | 1,831 |
| Designed WWT Water Production (gpm) | 2000 |
| CY / Day Insitu | 0 |

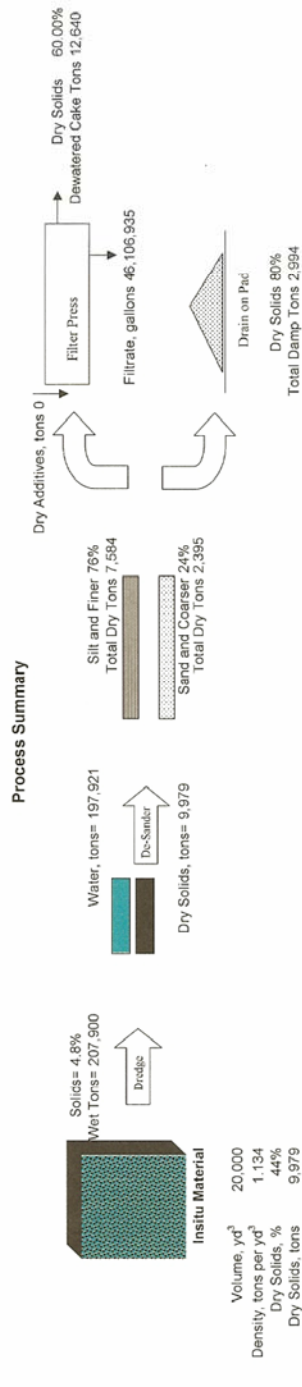

Figure 3. Sediment Processing Using De-sanders Followed By Filter Presses

2.4 Dewatering Equipment

The primary objective of the sediment dewatering process is the removal of sediments, and associated oils that contain PCBs, from the dredge fluid. The dewatering equipment consists of agitated mix tanks (feed tanks), a polymer injection system, fast feed pumps, and recessed chamber JWI filter presses. The dewatering process is designed to minimize the volume and therefore the weight of material that must be disposed, saving significant costs. The volume reduction is accomplished by squeezing the desanded slurry through polypropylene cloths at 225 pounds per square inch (psi), yielding a high solids cake and a filtrate stream for further treatment. The filter presses generally produce filter cake greater than 60 percent solids, with a clean filtrate stream (<50 mg/l total suspended solids (TSS)).

A total of six, 219 cubic-foot filter presses are in use on the project, providing a total volume of 1,314 cubic feet of filter cake material per drop (a drop refers to one cycle of filter press operation). The filter cake material is conveyed away from the press area to a central loadout bay, where the cake is loaded by front-end loaders into rail cars for transport to off-site disposal. The building was designed and constructed by the EPA/USACE to house all of the dewatering, wastewater treatment and rail car load-out facilities. A rail spur into the Site connects directly to the City of New Bedford rail yard, and to the main CSX railroad tracks.

2.5 Wastewater Treatment Equipment

The wastewater treatment system is designed to treat contaminants in the filtrate from the filter presses, namely oil and grease, PCBs, cadmium, chromium, copper, and lead. To meet the regulatory standards for direct discharge to a surface water body, the treatment process was designed with significant process redundancy. The design of the wastewater treatment plant was completed after extensive treatability studies. The average design capacity of the wastewater treatment system is 1,626 gpm, with a peak flow capacity of 2,000 gpm. The wastewater treatment equipment design is shown in the Process Flow Diagram (see Figure 4).

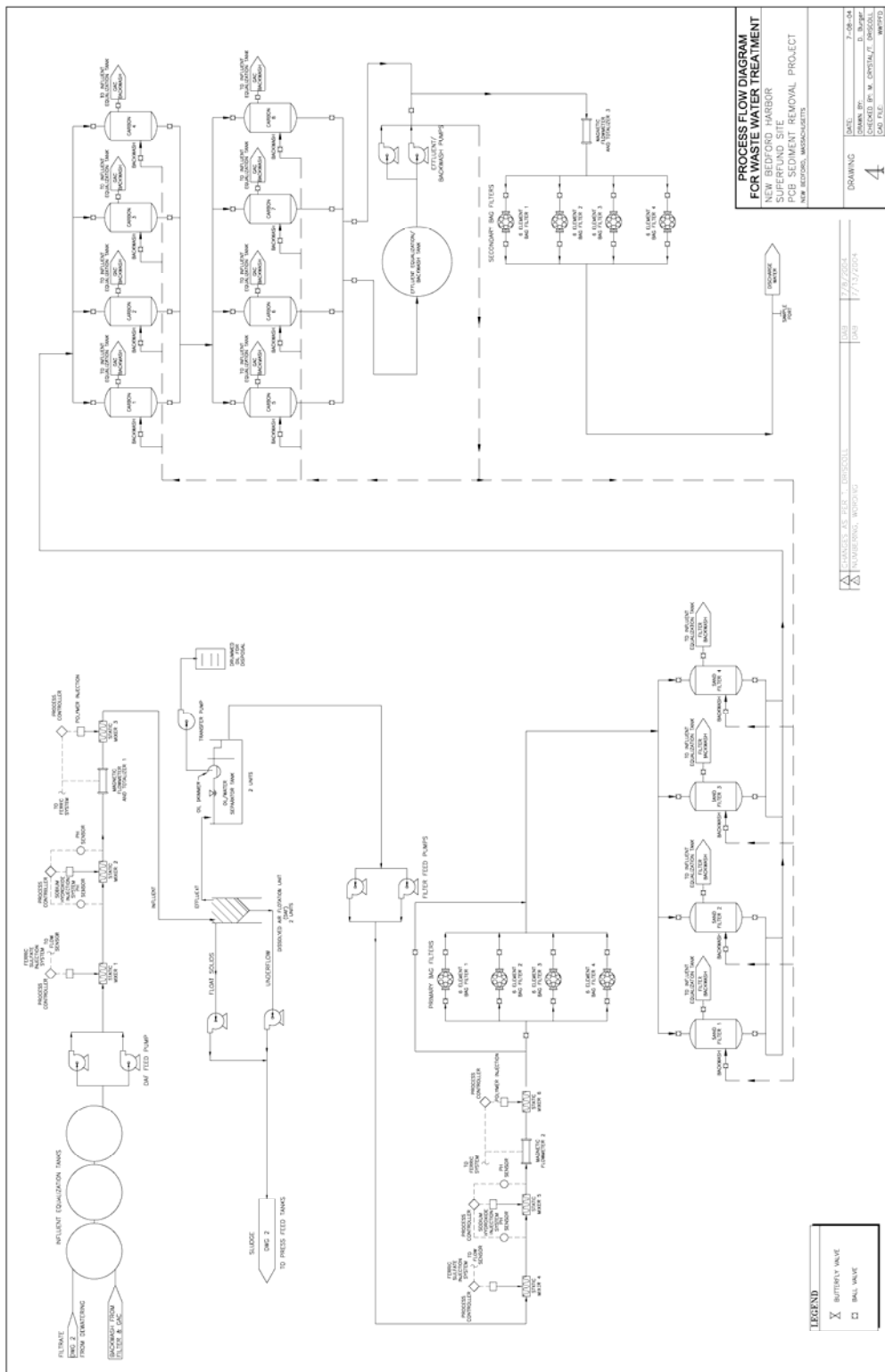

Figure 4. Process Flow diagram for Waste Water Treatment

Table 1 presents the expected filter press filtrate influent flow and load data used in the design selection and sizing of the wastewater treatment equipment.

Table 1. Wastewater Influent Characteristics (24-Hour Day)

| Influent Flow Rate | |
|-------------------------------|-----------|
| Average Day | 1,626 gpm |
| Peak Hour | 2,000 gpm |
| Total Suspended Solids | |
| mg/L | 50 |
| lbs/Day @ Average Flow | 415 |
| Total Organics | |
| mg/L | 2.0 |
| lbs/Day @ Average Flow | 16.6 |
| Total PCBs | |
| mg/L | 0.5 |
| lbs/Day @ Average Flow | 4.15 |
| Lead | |
| mg/L | 0.015 |
| lbs/Day @ Average Flow | 0.12 |
| Copper | |
| mg/L | 0.037 |
| lbs/Day @ Average Flow | 0.3071 |
| Cadmium | |
| mg/L | 0.005 |
| lbs/Day @ Average Flow | 0.0415 |
| Chromium | |
| mg/L | 0.005 |
| lbs/Day @ Average Flow | 0.0415 |

2.6 Basis for Wastewater Treatment System Design

Table 2 contains effluent water quality target concentrations that serve as the basis of design for the wastewater treatment system. These target effluent concentrations were included in the EPA ROD.

Table 2. Effluent Target Concentrations

| Parameter | Limit | Basis |
|-----------------------------|--------------|--|
| Total Suspended Solids mg/L | 0.1 | Requirement for meeting PCB and metal standards |
| Oil & Grease mg/L | 0.3 | Requirement for meeting oil and grease standards |
| Total Organics mg/L | 0.10 | Requirement for meeting TOC standards |
| PCBs mg/L per aroclor | 0.000065 | Discharge criteria in ROD |
| Lead mg/L | 0.0085 | Discharge criteria in ROD |
| Copper mg/L | 0.0056 | Discharge criteria in ROD |
| Cadmium mg/L | 0.0093 | Discharge criteria in ROD |
| Chromium mg/L | 0.05 | Discharge criteria in ROD |

The constituents listed in Table 2 are the basis for selecting the treatment process flow train.

A constituent of special concern is removal of suspended solids and oil and grease. Treatability studies completed on characteristic New Bedford sediments have shown that PCBs and heavy metals are generally bound up in the solids or in the oil and grease trapped in the sediment. Therefore, a key element of the design was to contain these contaminants in the wastewater treatment process.

Filtrate flow from the filter presses is first equalized in three tanks, in order to reduce flow and pollutant surges to the treatment processes. Following equalization, ferric sulfate is added in-line to precipitate heavy metals present in the filtrate. This process is known as iron coprecipitation. Sodium hydroxide is added to maintain a slightly alkaline pH necessary for optimum precipitation. Polymer is added to improve solids settling. After chemical treatment, the water flows to high-rate dissolved-air flotation (DAF) units to remove oil and ferric-metal solids generated by the iron coprecipitation process. Following the DAF units, the wastewater is pumped to bag filters and sand filters to remove remaining solids and coprecipitated metals.

Granular activated carbon (GAC) reactors are in place downstream of the bag filter/sand filter processes to remove remaining PCBs and metals. The GAC filters vessels are arranged in a series of two reactors per train to maximize carbon usage, and avoid breakthrough of PCBs. Additional bag filters are installed downstream of the GAC units to capture any carbon fines with adsorbed contaminants, prior to sampling and discharge of treated effluent into New Bedford Harbor.

3. ENGINEERING/SAFETY CHALLENGES DISCUSSION

Upon start up of the dredging and sediment processing systems in the fall of 2004, the project team was immediately confronted with a number of unanticipated operational conditions. These conditions posed unique engineering challenges that were unique to the specific conditions of the Site. To mitigate safety and operational concerns associated with these conditions, additional engineering controls were required. The most immediate and significant concern was the presence of elevated H₂S gas released at the coarse screen shaker operation after the dredged slurry arrived in the desanding building. Other operational challenges included removal of sunken debris prior to dredging and the accuracy of dredge progress tracking.

3.1 H₂S Control Problem

During the planning and mobilization stages of the project in 2004, engineering controls for off-gassing of the sediment were put into place at the desanding facility. A sprung structure type building was erected over the desanding process at Area C with negative pressure air venting to carbon treatment vessels. The building was intended to contain odors from decaying shellfish and other organic matter removed from the top few feet of sediment. H₂S gas, while not detected in appreciable quantities in EPA/NAE sediment sampling programs, was also expected to be safely contained within the sprung structure. A 10,000 cubic feet per minute (cfm) air ventilation system with GAC filtration units was installed to purify the air prior to venting.

Upon initiation of dredging and processing sediment, H₂S gas from the entering sediment was immediately detected in the desanding building at concentrations exceeding current permissible exposure levels. To protect the workers from exposure to elevated H₂S, the dredging operation was temporarily suspended in order to evaluate the cause of the elevated gas levels and to develop an engineering solution so that dredging could safely resume.

Often characterized with a rotten egg odor, H₂S is relatively harmless at low concentrations (<5 ppm). However, at higher concentrations the human nose is desensitized to the H₂S odor, and therefore a person can not detect its presence by smell alone. At 100 ppm by volume in air H₂S gas can be lethal to humans, and is therefore considered a very significant safety concern.

H₂S is often present in marine sediment due to normal anaerobic (no oxygen present) degradation of organic material. Combined sewer outfalls in the dredging area, connected to the City of New Bedford's sanitary system, were considered to be the primary cause for the elevated H₂S.

The hydrogen sulfide equilibrium reaction is shown below:



This equilibrium is highly pH dependent. At a neutral pH value of 7, 50 percent of the HS⁻ will remain as HS⁻ and 50 percent will be in the gaseous H₂S form.

If the pH is shifted to 5.0, 99 percent of sulfides will exist as H₂S (both gaseous and aqueous). If the pH is shifted to the alkaline range, for example, 8.5, 99 percent of the sulfides will exist as aqueous HS⁻. Therefore, it is desirable when sulfides are present to maintain alkaline conditions, or to take steps to remove soluble sulfides from solution.

3.1.1 H₂S Control Alternatives

The following conventional hydrogen sulfide control alternatives were identified and technically evaluated to resolve the problem:

1. Oxidate sulfide to sulfate using chemical oxidants;
2. Shift slurry pH from 7 to 8.5 or higher, which shifts sulfide equilibrium away from hydrogen sulfide gas to 99 percent HS⁻;
3. Add ferric sulfate, Fe₂(SO₄)₃, to eliminate H₂S by precipitating ferric sulfide (FeS) in conjunction with the production of sulfuric acid (H₂SO₄) according to the following equation: $\text{Fe}_2(\text{SO}_4)_3 + 3\text{H}_2\text{S} \rightarrow 2\text{FeS} \downarrow + \text{S}^- + 3\text{H}_2\text{SO}_4$;
4. An air-release system at the entrance to the Desanding Building prior to the shaker screens to vent gaseous H₂S to an enclosed air treatment system; and
5. A targeted air handling system over the shaker screens, hydrocyclones, and v-bottom tank to provide additional removal of gases liberated in that area.

Alternatives #3 and #5 listed above were selected as the most practical solutions for application at the Site. Adjustment of slurry pH, while shown to be effective in bench-scale tests, was deemed impractical in the slurry pipeline. The abrasive nature of the dredged slurry precluded any in-pipe instrument, meaning that pH could not be effectively controlled by an in-line pH control loop.

Bench tests were immediately conducted to determine the dosage of ferric sulfate required to control H₂S. The tests indicated that 300 mg/L was the most appropriate dosage considering the nature of the changing solids concentration in the dredge pipeline.

3.1.2 H₂S Control System Implementation Results

Within 14 days of encountering elevated H₂S in the sediment, an engineering control solution was implemented, using a 50 percent (Fe₂(SO₄)₃) solution injection combined with an air monitoring process. Ferric sulfate was injected into the dredge slurry approximately 2,500 feet upstream of the desanding plant, allowing 5-7 minutes of contact time to reduce or eliminate H₂S by precipitating FeS. This contact time was determined to be sufficient in the bench tests. Prior to implementation of the control system, hydrogen sulfide was released at concentrations in excess of 100 ppm by volume as the slurry flow transitioned from pressure flow in the pipeline to atmospheric pressure at the desander. After the addition of ferric sulfate, H₂S gas concentrations at the desander were reduced to generally 0.1-0.2 ppm by volume.

As a redundant safety precaution, workers potentially exposed to H₂S within the desanding building were required to operate with OSHA Level B supplied air.

With the ferric sulfate system and redundant air supply systems in place, dredging operations continued uninterrupted for the remainder of the 2004 season. Although the ferric injection system was effective in reducing the levels of H₂S in the Desanding Building, there were still intermittent spikes of H₂S. Workers in that building continued to wear OSHA Level B Personal Protective Equipment (PPE) as a back-up safety precaution for the remainder of the 2004 processing season.

3.1.3 H₂S Control System Enhancements

During the 2004 dredging season, it also was determined that the greatest release of H₂S gas was caused by the desanding unit shaker screen. To alleviate this condition, an enhanced air ventilation system, including air-capture hoods over the desanding units and more robust air flow and filtration systems were engineered and installed for the 2005 field season. The enhanced air system allowed the team to reduce the level of personal protection in the Desanding building from OSHA level B to modified level D.

A second engineering improvement, implemented to increase safety and increase production, was the automation of the ferric sulfate injection system. It was noted in 2004 that spikes of hydrogen

sulfide correlated to deeper cuts by the dredges. The automated system uses flow meters and nuclear density meters to continuously calculate the mass flow of the dredge slurry. Nuclear density meters were used in place of other density devices to avoid inserting any kind of obstruction in the slurry pipeline.

The rate of ferric sulfate injection was paced based on the mass flow of the slurry, using a direct correlation between density of dredged material and slurry flow rate. The flow signal and density signal from the respective meters are fed to an integrating controller which converts those signals to a mass flow (flow times density), and generates a 4-20 mA signal that is used to pace the output of the ferric sulfate feed pumps.

The automated system successfully reduced the safety risks associated with manual operation and significantly reduced the amount of ferric sulfate used because the amount of ferric sulfate added varied proportionately with the density and flow rate of the slurry.

3.2 Debris Removal

The New Bedford Harbor region has historically been an area of significant urban land use, including light industry, textile mills, housing complexes, and fisheries related businesses. As such, the presence of sunken and buried debris in the harbor sediment is common. The hydraulic dredge being used on the project, with its submerged auger and pump suction, is particularly vulnerable to fouling by sunken debris, causing production delays, potential equipment damage, and extended down time. In anticipation of these delays, an aggressive debris removal operation is performed prior to dredging, using a barge-mounted excavator to pull material from the top 1-2 feet of sediment.

3.2.1 Debris Removal System Problem

The initial attempts at debris removal operation used a conventional excavator and a perforated, 2 cy bucket to pull debris from the mud. However, it quickly became apparent that, because the operator did not have a means to monitor vertical control with the excavator, the amount of sediment disruption and volume of contaminated sediment removed with the bucket was unacceptable. In addition, the disturbed sediment created high turbidity levels in the water column near the operation. The high levels threatened to exceed the EPA established water column turbidity thresholds [300 nephelometric turbidity units (ntu)] for the perimeter of the dredge zone. Consequently, this method of debris removal was terminated within the first week during the 2004 dredge season. Ceasing the debris removal operations created a situation where dredging proceeded at the risk of encountering sunken debris.

3.2.2 Engineered Refinements to the Debris Removal System Results

During the 2005 winter off-season, engineering efforts were made to develop a debris-removal system that would satisfy the requirements to remove debris, while reducing disturbances to the sediment, and minimizing water column turbidity levels. To satisfy these criteria, a custom-made hydraulic debris removal tool was developed.

During the next dredging season in the fall of 2005, debris removal operations resumed using an excavator-mounted, hydraulic rake system with a separate rake "thumb" attachment that allowed the operator to remove debris from the sediment without suspending excessive material in the water column. The excavator was also retrofitted with an additional extension boom to provide greater reach into the sediment. In addition, a computer-operated, depth-monitoring station was installed within the cab of the excavator, allowing the operator to view a digital display of the debris removal rake depth on a computer screen mounted in the cab.

3.3 Dredge Tracking Process

The pre-established target dredge depth throughout the harbor was the theoretical depth below mudline to remove sediment above the clean-up action levels. This depth, referred to as z^* , was derived by other consultants to the EPA/USACE, using a comprehensive data set, geostatistical analyses, and modeling methods that predicted compliance depths between analytical sampling locations.

3.3.1 Dredge Tracking System Problem

The dredge area is divided into 25-foot by 25-foot blocks (z -blocks) that represent the target sediment removal depths across the harbor. The amount of sediment to remove within each z -block corresponds with an associated target “clean” elevation predicted by the model. The clean elevation is the elevation to dredge to in order to reach z^* . Accurate dredge monitoring is crucial to ensure that the target cleanup elevations are being attained and that costly overdredging is avoided.

At the beginning of the project in 2004, dredging elevations were solely determined based upon a stationary laser set up on shore and a surveyor’s rod with laser receiver used to measure elevation for vertical control on the dredge. Horizontal control was measured by visual observation of the position of the dredge relative to known sheet pile locations installed in the dredge area. Although this was the accepted method for dredge tracking during the early stages of the project, the degree of accuracy required to assure that the z^* depths were attained demanded that the survey and tracking system be enhanced for subsequent dredge seasons.

3.3.2 Dredge Tracking Process Enhancements Results

Prior to dredging activities in 2005, a bathymetric survey of each dredge area was conducted to assess the change in the harbor bottom elevation in the proposed dredge compared to the most current comprehensive USACE bathymetric survey conducted in 1999. The 1999 bathymetric survey provided the base data for the creation of z^* . All bathymetric surveys are conducted relative to National Geodetic Vertical Datum 1929 (NGVD 29) and relative to North American Datum 1983 (NAD 83), for vertical control and for horizontal control, respectively. This harbor bottom assessment allowed the project team to modify the cut depths in the z -blocks depending on whether erosion or deposition had occurred in areas since the 1999 bathymetric survey and the genesis of z^* .

The progress of dredge cut monitoring was enhanced using several different methods. First, as previously done in 2004, the vertical progress is monitored by the dredge operator using a surveyor’s rod with an attached bottom plate, a rotating laser datum, and a receiver to gauge the cut depths relative to the reference datum. The horizontal progress is tracked by the dredge operator using a visual relationship of the dredge relative to the sheet piles and temporary survey stakes placed in the dredge area on 25-foot intervals corresponding with the north-south and east-west intersections of the 25-foot z^* blocks. The horizontal progress of the dredge is also tracked electronically, using GPS equipment that is programmed to continuously collect horizontal position data as the dredge progresses. The GPS information is reviewed at the end of each day to document the area covered and to identify areas that may have been missed by the dredge. This information is then used to plan the following day’s dredging activities. Figure 5 is an example of the daily GPS data and the area tracked by the GPS while dredging.

Dredging progress is also physically measured each week following the completion of dredging activities. A bathymetric survey of the areas dredged during the previous week is conducted on Saturday, typically a non-dredging day. Quality control (QC) surveys are also periodically performed within the dredge area during dredging for verification of cut depths. The QC survey utilizes the GPS and adjustable rod and plate equipment to verify vertical measurements (relative to NGVD 29) and horizontal measurements (relative to NAD 83) made by the weekly bathymetric survey. Figure 6 shows data gathered from a bathymetry survey with GPS elevation check data overlaid for QC purposes.

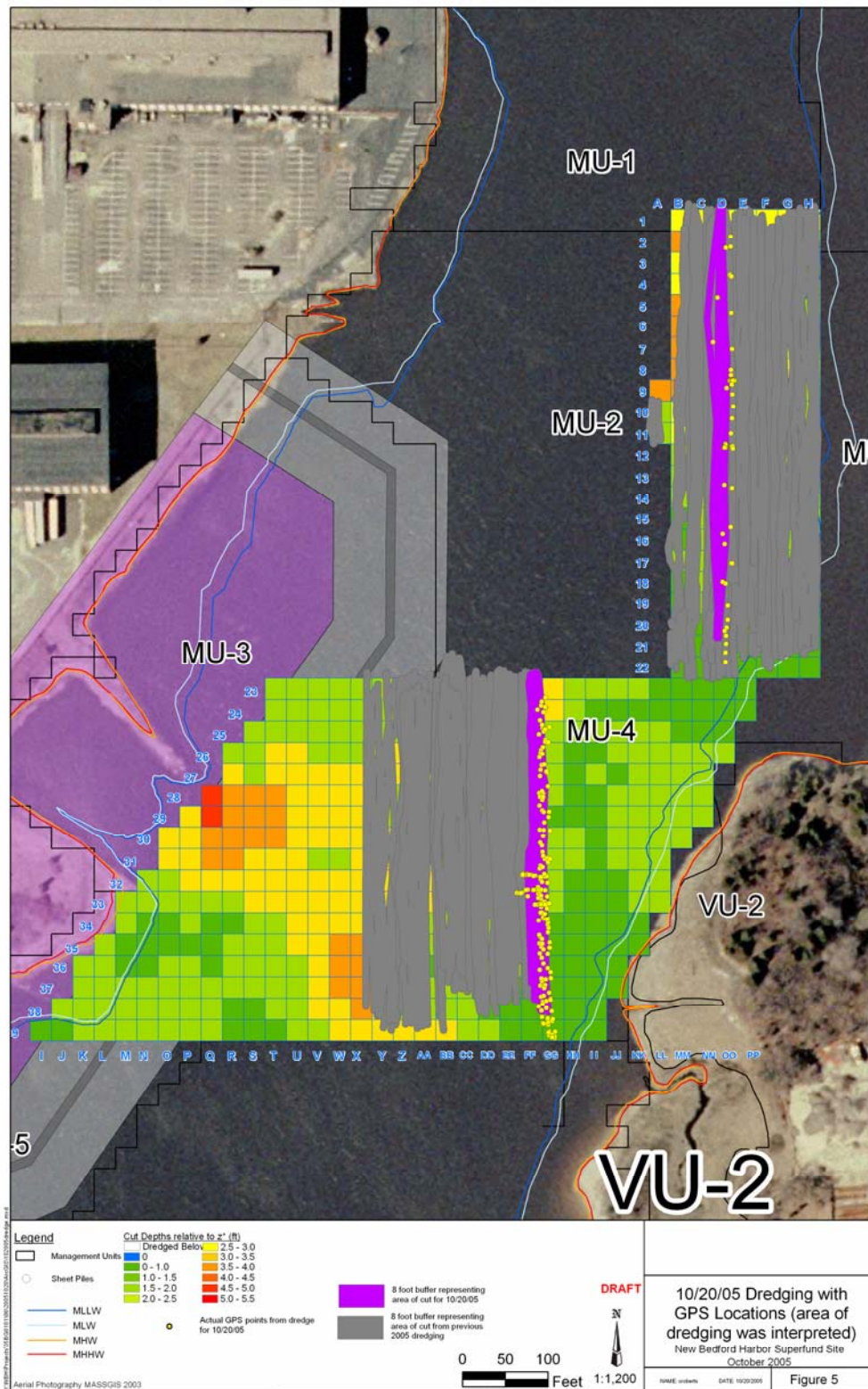

Figure 5. 10/20/05 Dredging with GPS Locations

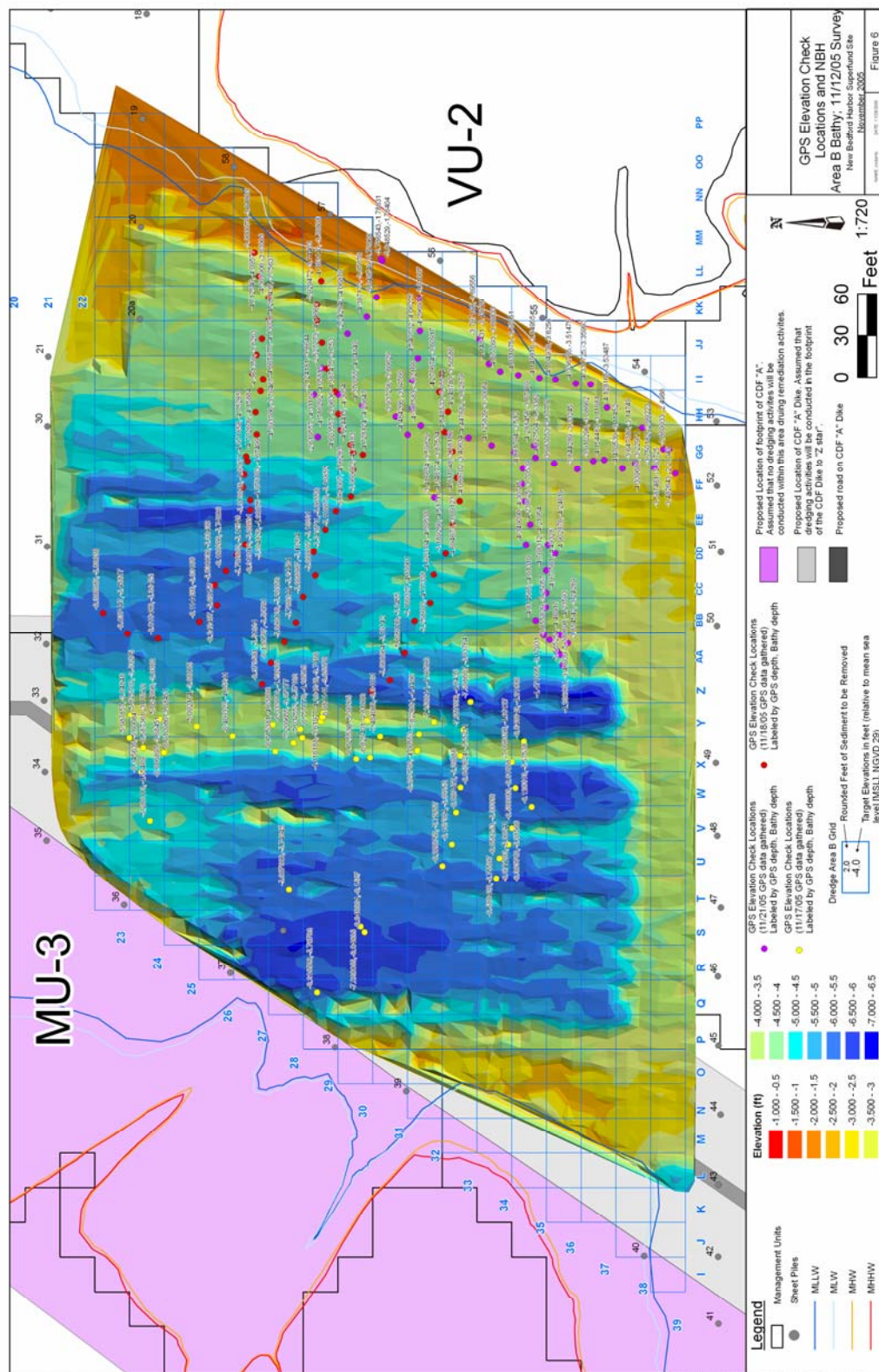

Figure 6. GPS Elevation Check Locations and New Bedford Harbor Area B Bathymetry

At the conclusion of dredging activities each season, a final bathymetric survey is completed. The final survey provides an accurate depiction of the bottom conditions and a post-dredge surface to compare to the pre-dredge bathymetric survey. By comparing the two, the volume of sediment

removed can be calculated. Figure 7 shows the net change in bottom elevation and corresponding volume of sediment removed calculated from the bathymetric survey data.

4. CONCLUSION/ACCOMPLISHMENTS

Despite the technical challenges that the project team has faced during the first two seasons of dredging at New Bedford Harbor, the amount of contaminated sediment removed per day of dredging has been impressive. The table below briefly describes the accomplishments over the first two dredging seasons.

Table 3. 2004 and 2005 Field Season Accomplishments Summary

| | |
|---|--------------------------|
| Harbor Dredging | 83 days |
| Area of Harbor Dredged | 10.4 acres |
| Volume of Sediment Dredged | 37,491 cy |
| Average Volume Dredged Per Day | 452 cy |
| Amount of material disposed or stockpiled | 21,332 tons (dry weight) |
| Amount of filtrate successfully treated | 38,640,600 gal |

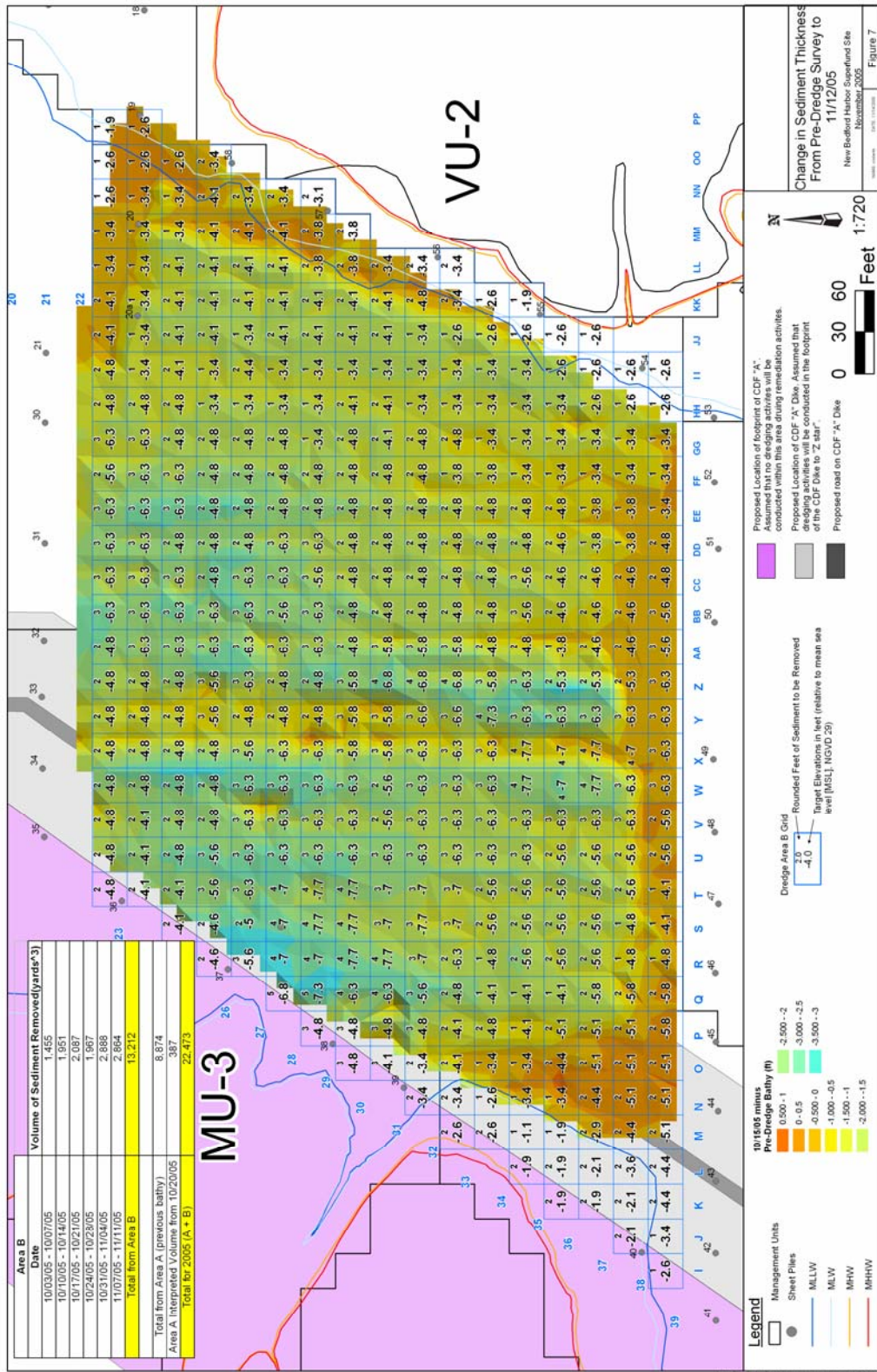

Figure 7. Change in Sediment Thickness from Pre-Dredge Survey

Chapter 25

PHYTOEXTRACTION AND PHYTOVOLATILIZATION OF ARSENIC FROM AS-CONTAMINATED SOILS BY *PTERIS VITTATA*

Masayuki Sakakibara¹, Aya Watanabe¹, Sakae Sano², Masahiro Inoue¹, and Toshikazu Kaise³

¹Graduate School of Sciences and Engineering, Ehime University, 2-5 Bunkyo-cho, Matsuyama, 790-8577 Japan; ²Earth Science Laboratory, Faculty of Education, Ehime University, ³Tokyo University of Pharmacy and Life Science, 1432-1 Horinouchi, Hachioji 192-0392, Japan

Abstract: Phytoremediation of metal contaminated soil and water is a low cost method of remediation, which allows some extracted metals to be recycled for economic use. The use of phytoextraction and phytovolatilization of metals by plants offers a viable remediation on commercial projects. Arsenic is of great environmental concern due to its extensive contamination and toxicity. Ma *et al.* (2001) recently discovered the first known and extremely efficient arsenic hyperaccumulating plant, *Pteris vittata*. If we can use phytovolatilization for As-contaminated soils, it could minimize the production of As-laden plant material and the duration of remediation. Several greenhouse experiments conducted by us have shown that the material balance of As between uptake by *P. vittata* and reduction from As-polluted soils has not been maintained. Vapor samples were collected to determine volatilization of arsenic compounds from fronds of *P. vittata* grown in As-polluted soil. A low-density polyethylene bottle was placed over a stem and sealed at the open bottleneck with sealant and tape to produce a tight seal around the stem and chambers for a period of 2–7 days. Concentration of arsenic in trap samples was measured by ICP-MS and speciation of arsenic was analyzed using HPLC/ICP-MS system. Concentrations in collected water samples (ca. 0.6–5.9ml) reached 10.7–30.8 µg-As/L (2–7 days). Percentages of arsenic components in one sample were 37% for arsenite and 63% for arsenate. Our results suggest that *P. vittata* is a plant species that is effective at volatilizing As; it removed about 90% of the total uptake of As from As-contaminated soils in the greenhouse, where the environment was similar to the subtropics. However, if a large amount of arsenic had been released from the contaminated site into the atmosphere by the fern, the process may have caused a secondary As-contamination to the surrounding environments.

Key words: Arsenic, *Pteris vittata*, phytoextraction, volatilization, arsenite, arsenate, greenhouse experiment

1. INTRODUCTION

Some metal contaminants such as As, Hg, and Se also exist as gaseous species in the environment. In the recent years, researchers have searched for naturally occurring or genetically modified plants that are capable of absorbing elemental forms of these metals from the soil, biologically converting them into gaseous species within the plant, and releasing them into the atmosphere. This process is called phytovolatilization, the most controversial phytoremediation technology. Since Hg and Se are toxic (Wilber, 1980; Suszcynsky and Shann, 1995) there is an uncertainty whether the volatilization of these elements into the atmosphere is safe (Watanabe, 1997). Se phytovolatilization is the process by which gaseous Se is produced from inorganic or organic Se compounds (Lewis *et al.* 1966; Terry *et al.* 1992; Bañuelos *et al.*, 1993a, b; McGrath, 1998). Furthermore, the volatilization is particularly attractive for the phytoremediation of Se-contaminated environment because this element is a serious problem in many parts of the world with Se-rich soil (Brooks, 1998). Moreover, in recent years, there has been a considerable effort to insert bacterial Hg ion reductase genes into plants for Hg

phytovolatilization (Rugh *et al.*, 1996; Heaton *et al.*, 1998; Rugh *et al.*, 1998; Bizily *et al.*, 1999). On the other hand, there have been no efforts to genetically engineer plants that volatilize As. The most efficacious remediation of arsenic has been suggested where plants extract arsenic from soil and hyperaccumulate it aboveground in fronds and stems.

Pollution is a worldwide problem and there is tremendous demand for the cleanup of As-contaminated soil and water. Some plant species growing on As-contaminated soils are As tolerant and accumulate very high concentrations of As (As accumulators). An arsenic hyperaccumulator, *Pteris vittata* L. (Chinese brake), was first discovered in China by means of a field survey and greenhouse cultivation. The plant's abilities to produce large quantities of root exudates (to solubilize soil arsenic), effectively translocate arsenic to the fronds (up to 95%), reduce arsenic from arsenate-As(V) to arsenite-As(III) (up to 100% arsenite) in the fronds, and keep high concentration of P in the roots have contributed to its capability to hyperaccumulate arsenic, making it a prime candidate for use in phytoremediation of As-contaminated sites (Ma *et al.*, 2001).

The objective of this study was to determine *P. vittata*'s ability to metabolize As into volatile As forms (phytovolatilization) along with the application of phytoremediation for the cleanup of As-contaminated environments.

2. MATERIAL AND METHODS

2.1 Greenhouse experiment

The As-contaminated soil used in this experiment was collected from a deposit site of neutralized acid mine drainage in Japan. It accumulated up to 6,540±380 mg As/kg-dry weight (DW).

One healthy fern with 6–7 fronds, about six months old, was planted in each pot containing about 12 kg of soil. The plants were grown for 18 months in a greenhouse where the average temperature varied from 25 (night) to 45°C (day) in summer and 10 (night) and 25°C (day) in winter. The concentration of As in the fronds ranged from 3,830 to 11,020 mg/kg-DW.

Water vapor samples were collected to determine volatilization of arsenic compounds from leaves of the fern to the atmosphere. A low-density polyethylene bottle (20L) was placed over a stem and sealed at the open bottleneck with sealant and tape to produce a tight seal around the stem and chambers during a 2–7 day period (Fig. 1). The bottles were fixed in the same location during sample collection.

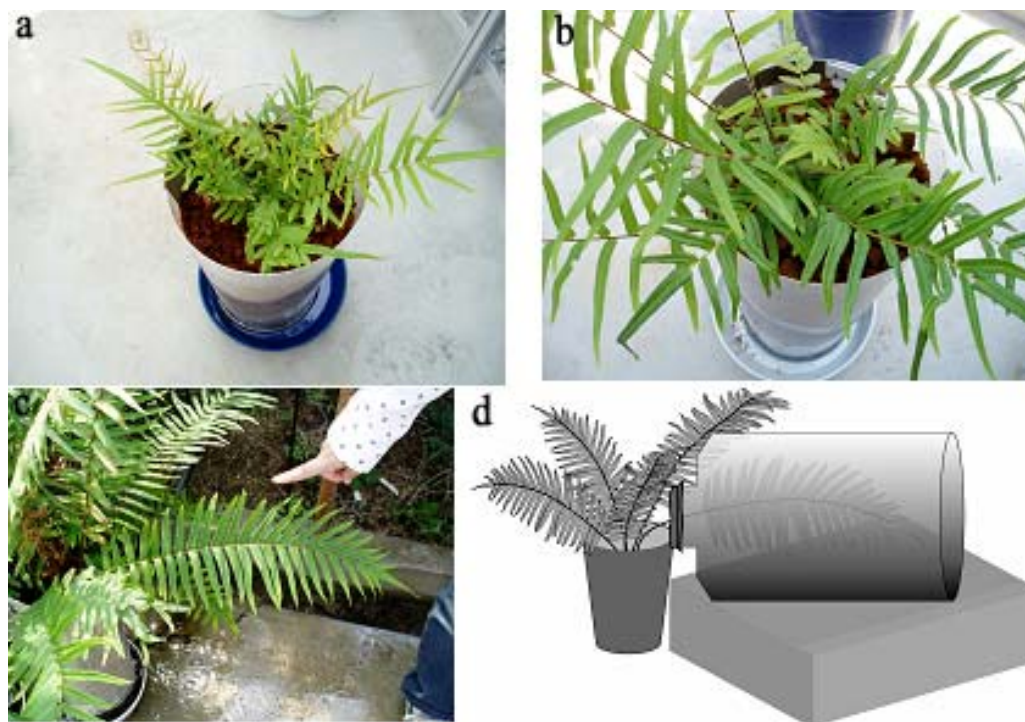

Figure 1. *Pteris vittata* for the experiment of volatilization of arsenic. a. the transplanted fern in the As-contaminated soil, b. the fern growing up, c. the frond for the volatilizing experiment, d. experiment for collecting vapor from the fern.

2.2 Analytical methods

The speciation and quantification of As were accomplished by using HPLC to separate the species and ICP-MS to detect them. Detection of arsenic species was accomplished with an ELAN® DRC-e ICP-MS (PerkinElmer SCIEX) at Tokyo University of Pharmacy and Life Science (Kamidate *et al.*, 2000). Total arsenic concentrations were also measured without speciation, using conventional nebulization into the ICP-MS at Ehime University (Sano *et al.*, 2005).

3. RESULTS

Three volatile water samples from the fern were collected for chemical analysis by ICP-MS. As-concentrations in the collected water samples were 0.74 $\mu\text{g-As/L}$ in 0.6 cc (2 days), 16.1 $\mu\text{g-As/L}$ in 5.9 cc (7 days), and 30.8 $\mu\text{g-As/L}$ in 4.1 cc (7 days). As-concentrations of blank were 0.15 $\mu\text{g-As/L}$ in 30 cc (7 days). The result of the experiment revealed that *P. vittata* is a plant species that releases As from the fronds.

Chromatographical analysis using HPLC-ICP-MS for arsenic of volatilized water detected only arsenite and arsenate. Chromatograms are presented in Fig. 2, showing that good separations were achieved for the As species. Percentages of arsenic components in one sample were 37% for arsenite and 63% for arsenate.

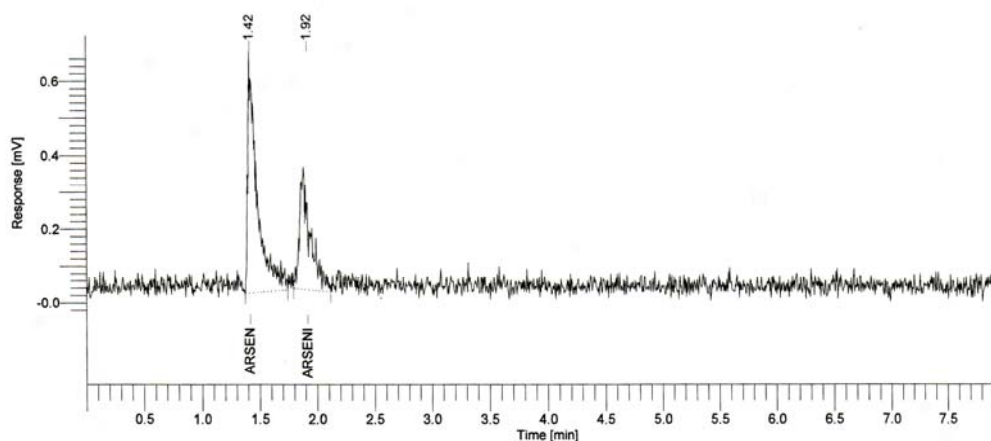

Figure 2. Chromatograms (HPLC-ICP-MS) of vapor collected from *Pteris vittata* for As speciation

4. DISCUSSION

For phytoextraction, the total amount of arsenic accumulation by the fern should be considered because it takes into account both biomass production and As concentration, measuring the potential effectiveness of a plant for phytoextraction. The amount of arsenic found in the plant tissue was well explained by the decrease in total soil arsenic after growing *P. vittata* (Tu *et al.*, 2002). Moreover, the most striking feature associated with the As hyperaccumulation by *P. vittata* lies in the exceedingly efficient transport from roots to shoots. In the depletion experiments (8 h) by Wang *et al.* (2002), between 50% and 78% of As taken up had already been transported from the culture to the fronds.

On the other hand, only 15–20% of the total As removed from the soil can be accounted for that accumulated by the fern in our recent experiments (Sakakibara *et al.*, 2004a; Watanabe *et al.*, 2005; and unpublished data).

Speciation in plant tissues by HPLC-ICP-MS is conducted on methanol/water extracts, including previous studies of As-hyperaccumulating ferns, where only arsenate and arsenite have been detected (Ma *et al.*, 2001; Francesconi *et al.*, 2002). A few studies have reported that a reduction of arsenic, arsenate ion (As^{5+}) to arsenite ion (As^{3+}), occurred in the plant body (Ma *et al.*, 2001; Lombi *et al.*, 2002; Wang *et al.*, 2002; Huang *et al.*, 2004). Wang *et al.* (2002) concluded that arsenate was taken up by *P. vittata* via the phosphate transporters, reduced to arsenite, and then sequestered in the fronds primarily as As(III). Huang *et al.* (2004) reported that the As in the fern were mainly coordinated with oxygen in the reduced state, As (III), and the reduction of As(V) occurred in the root after it was taken up, by using synchrotron radiation extended X-ray absorption fine structure (SR EXAFS). Based on our experiments, *P. vittata* accumulated large amounts of inorganic As compounds, mainly arsenite and arsenate, in their tissues and released large amounts of As from the fronds. *P. vittata* is promising for the phytoremediation of As-contaminated soil because of its remarkable ability to phytoextract As and release the accumulated As in the fronds. However, the process of volatilization of arsenic from *Pteris vittata* remains unknown.

P. vittata may release their secretions including arsenic compounds, through secretory glands at the edge of the fronds. Hokura *et al.* (2006) revealed that the arsenic distributions of the fern were successfully measured by the μ -SR-XRF analysis, and As(V) in the culture medium was reduced to As(III) in the tissue after absorption. The As contents are characteristically high at the edge of the frond concentrating secretory glands, based on the As imaging of XRF. However, if large amount of arsenic would have been removed from the contaminated site into the atmosphere by the fern, then the process would have caused a secondary As-contamination to the surrounding environment.

5. CONCLUSION

It was determined that vapor released from the frond of *P. vittata* included arsenic compounds, arsenite and arsenate. The results suggest that *P. vittata* effectively volatilizes As; it removed a maximum ratio of 90% of the total uptake of As from As-contaminated soils in greenhouse, where the environment was similar to the subtropics. However, if a large amount of arsenic had been released from the contaminated site into the atmosphere by the fern, the process may have caused a secondary As-contamination to the surrounding environment.

ACKNOWLEDGEMENTS

We would like to thank the Grant for Research and Development Assistance of Ehime University for their support. We also thank Dr. Kuramoto for his assistance in ICP-MS analyses and Mr. Toshihito Kondo in FUJITA Co. Ltd. for providing the seedlings of *P. vittata*.

REFERENCES

- Bañuelos, G.S., Cardon, G., Mackey, B., Ben-Asher, J., Wu, L.P., Beuselinck, P., Akohoue, S., and Zambruski, S. 1993a. Boron and selenium removal in B-laden soils by four sprinkler irrigated plant species. *J. Environ. Qual.* 22, 786-797.
- Bañuelos, G.S., Mead, R.R., and Hoffman, G.J. 1993b. Accumulation of selenium in wild mustard irrigated with agricultural effluent. *Agri. Ecosys. Environ.* 43, 119-126.
- Bizily, S.P., Rugh, C.L., Summers, A.O., and Meagher, R.B. 1999. Phytoremediation of methylmercury pollution: *Mer B* expression in *Arabidopsis thaliana* confers resistance to organomercurials. *Proc. Natl. Acad. Sci. USA.* 96, 6808-6813.
- Brooks, R.R. 1998. Plants that hyperaccumulate heavy metals. Wallingford, CAB International., 384.
- Francesconi, K., Visoottiviseth, P., Sridokchan, W., and Goessler, W. 2002. Arsenic species in an arsenic hyperaccumulating fern, *Pityrogramma calomelanos*: a potential phytoremediator of arsenic-contaminated soils. *Sci. Total Environ.* 284, 27-35.
- Heaton, A.C.P., Rugh, C.L., Wang, N., and Meagher, R.B. 1998. Phytoremediation of mercury - and methylmercury - polluted soils using genetically engineered plants. *J. Soil Contam.* 7, 497-510.
- Hokura, A., Onuma, R., Terada, Y., Kitajima, N., Abe, T., Saito, H., Yoshida, S., and Nakai, I. 2006. Arsenic distribution and speciation in an arsenic hyperaccumulator fern by X-ray spectrometry utilizing a synchrotron radiation source. *J. Anal. Atom. Spectr.* 21, 321-328.
- Huang, Z.-C., Chen, T.-B., Lei, M., and Hum T-D. 2004. Direct determination of arsenic species in arsenic hyperaccumulator *Pteris vittata* by EXAFS. *Acta Botan. Sin.* 46, 46-50.
- Kaimidate, Y., Yamada, M., Furusho, Y., Kuroiwa, T., Kaise, T., and Fujiwara, K. 2000. A rapid method for the detection of arsenic compounds in biological samples with semimicro column and an inductively coupled plasma mass spectrometer. *Biomed. Res. Trace Elem.* 11, 445-446 (Japanese with English abstract).
- Lewis, B.G., Johnson, C.M., and Delwiche, C.C. 1966. Release of volatile selenium compounds by plants: collection procedures and preliminary observations. *J. Agri. Food Chem.* 14, 638- 640.
- Lombi, E., Zhao, F.J., Fuhrmann, M., Ma, L.Q., and McGrath S.P. 2002. Arsenic distribution and speciation in the fronds of the hyperaccumulator *Pteris vittata*. *New Phytologist*, 156, 195-203.
- Ma, L.Q., Komar, K.M., Tu, U.C., Zhang, W., Cai, Y., and Kennelley, E.D. 2001. A fern that hyperaccumulates arsenic. *Nature* 409, 579.
- McGrath, S.P. 1998. Phytoextraction for soil remediation. In: Plants that hyperaccumulate heavy metals: their role in phytoremediation, microbiology, archaeology, mineral exploration and phytomining, pp. 261-288 (Brooks, R.R., Ed.), New York, CAB International.
- McGrath, S.P., Zhao, F.J., and Lombi, E. 2002. Phytoremediation of metals, metalloids, and radionuclides. *Adv. Agron.* 75, 1-56.
- Rugh, C.L., Wilde, H.D., Stacks, N.M., Thompson, D.M., Summers, A.O., and Meagher, R.B. 1996. Mercuric ion reduction and resistance in transgenic *Arabidopsis thaliana* plants expressing a modified bacterial *merA* gene. *Proc. Natl. Acad. Sci. USA.* 93, 3182-3187.
- Rugh, C.L., Gragson, G.M., Meagher, R.B., and Merkle, S.A. 1998. Toxic mercury reduction and remediation using transgenic plants with a modified bacterial gene. *Hortsci.* 33, 618-621.
- Sakakibara, M., Takagi, K., Inoue, M., Kubota, R., Hori, R.S., and Sano, S. 2004. Preliminary experiments on phytoremediation by *Pteris vittata* L. of altered including arsenopyrite. *Proc. 14th Symp. Geo-Environ. Geo-Tech.* 11-20 (Japanese with English abstract).

- Sano, S., Sakakibara, S., and Watanabe, A. 2005. Quantitative analyses of arsenic in plants by instrumental neutron activation analyses and inductively coupled plasma-mass spectrometry. Mem. Fac. Sci. Ehime Univ., 11, 1-6 (Japanese with English abstract).
- Suszcynsky, E.M. and Shann, J.R. 1995. Phytotoxicity and accumulation of mercury subjected to different exposure routes. Environ. Toxic. Chem. 14, 61-67.
- Terry, N., Carlson, C., Raab, T.K., and Zayed, A. 1992. Rates of selenium volatilization among crop species. J. Environ. Qual. 21, 341-344.
- Tu, C., Ma, L.Q. and Bondada, B. 2002. Arsenic accumulation in the hyper-accumulator Chinese Brake and its utilization potential for phytoremediation. J. Environ. Qual., 31, 1671-1675.
- Wang, J., Zhao, F.J., Meharg, A.A., Raab, A., Feldmann, J., and McGrath, S.P. 2002. Mechanisms of Arsenic Hyperaccumulation in *Pteris vittata*. Uptake Kinetics, Interactions with Phosphate, and Arsenic Speciation. Plant. Physiol. 130, 1552-1561.
- Watanabe, A., Sakakibara, M., Sano, S., Kondo T., Inoue, M., Hori, R. S., Suzuki, T., and Takehana, D. 2005. Greenhouse pot experiment of phytoremediation of mudstone leaching arsenic by *Pteris vittata* L. Mem. Fac. Sci. Ehime Univ. 11, 13-18 (Japanese with English abstract).
- Watanabe, M.E. 1997. Phytoremediation on the brink of commercialization. Environ. Sci. Techn. 31, 182-186.
- Wilber, C.G., 1980, Toxicology of selenium: a review. Clin. Toxicol. 17, 171-230.

Chapter 26

REMEDICATION OF A CLAY CONTAMINATED WITH PETROLEUM HYDROCARBONS USING SOIL REAGENT MIXING

V. Schifano and N. Thurston

Arcadis Geraghty and Miller International Ltd, Newmarket, CB8 7FA, UK

Abstract: Soil reagent mixing (SRM) is a remediation technique whereby powder or slurried reagents are delivered and mixed in-situ or ex-situ with contaminated soils or sediments by augers or other types of soil mixers. This paper summarises the work carried out for a laboratory treatability study of SRM on clayey soil samples contaminated with petroleum hydrocarbon compounds from a petrol filling station site in Kent, UK. The study examined the effects of mixing binder reagents on the total soil and leachate concentrations of hydrocarbons. Quicklime, hydrated lime and ordinary Portland cement, in a number of different formulations, were used in the study. Furthermore, the addition of gypsum to some reagent formulations was evaluated in an attempt to improve the strength of the binder/soil mix. Temperature and evolution of volatiles were monitored during the mixing of soils with the reagents. The mixing of soil with binder reagents resulted in changes in physical and physico-chemical properties of the clay, and in significant decreases in total soils and leachate concentrations of petroleum hydrocarbon compounds. The mechanisms responsible for the decreases in concentrations were examined. Significant increases in the remoulded strength of the clay were observed upon addition of certain binder formulations.

Key words: Remediation; Soil Reagent Mixing; Solidification; Stabilisation; Clay; Petroleum; Hydrocarbons; Lime; Cement; Gypsum.

1. INTRODUCTION

Soil Reagent Mixing (SRM) is a remediation technique whereby powder or slurried reagents are mixed in-situ or ex-situ with contaminated soils or sediments by augers or other types of soil mixers. SRM is one of the few available remedial technologies to effectively treat low permeability soils. SRM with binders is an established treatment technology to reduce leachability and physically immobilize heavy metals in soils (Bone et al., 2004). This type of SRM application is commonly referred to as stabilization / solidification. A more limited experience exists for the application of SRM with binders to soils contaminated with organics, in particular hydrocarbons, due to a limited understanding of the mechanisms that take place. Volatilization, encapsulation within the clay particles macroaggregates produced by the clay / binder / porewater reactions (solidification) and chemical degradation seem to be the mechanisms responsible for the hydrocarbons treatment in SRM with binders rather than stabilization.

A limited number of studies exist on quicklime remediation of soils contaminated with organics, in particular petroleum hydrocarbons (Schifano et al, 2005; Schifano et al, 2006). Schifano et al, 2006 carried out laboratory treatability studies to treat a number of cohesive soils contaminated with petroleum hydrocarbons using quicklime mixing. The results of the study showed reduction of total soil and leachate hydrocarbon concentrations upon quicklime mixing. Increases in temperature, due to the exothermic hydration reaction of quicklime when in contact with porewater, appeared to promote the volatilization of the light petrol fractions (C5-C12) but were considered not entirely responsible for their concentration decreases. The decrease in concentrations of less volatile hydrocarbon fractions

was attributed, at least in part, to a time-dependent mechanism of encapsulation of the large hydrocarbon molecules within clay macro-aggregates, produced by the clay / quicklime / porewater reactions. An initial high moisture content or addition of water during mixing hindered the volatilization of light hydrocarbons and resulted in higher post-treatment concentrations of volatiles in some silt and sand/kaolinite mixture samples. However, higher moisture contents in silt samples resulted in improved mixability, a more homogeneous distribution of quicklime and therefore enhanced encapsulation and better concentration reduction of heavy aromatics.

The clay / quicklime / porewater reactions, which include flocculation, ion exchange, carbonation, dissolution of clay minerals and pozzolanic reactions (Goldberg and Klein, 1952; Eades and Grim, 1960; Glenn and Handy, 1963; Diamond et al., 1964; Diamond and Kinter, 1965; Brinkman, 1979; Bell, 1996) are considered to be responsible for the encapsulation of hydrocarbons and for the increase in the drained and undrained shear strength of cohesive soils reported in the literature for binder treated soils (Wissa et al., 1965; Balasubramaniam et al., 1989; Mesri et al., 1999; Lindh, 2004; Holm, 2005). In addition, mechanisms, which may contribute to the formation of the clay macro-aggregates and improve the clay strength, may be cation linking, in which Ca ions link clay particles through their negative edges and binding of the clay particles by the silicate hydrates gels produced by the pozzolanic reactions (Clare and Cruchley, 1957; Diamond and Kinter, 1965; Croft, 1967).

Gypsum is often used as an additive to accelerate reactions and improve the strength of stabilised / solidified contaminated wastes (Conner, 1990). It has also been reported to reduce plasticity and swelling of expansive clays (Lopez-Lara et al., 1999; Graber et al., 2006), and increase strength of lime treated clays (Pimraksa and Thongchai, 2006). In particular, Pimraksa and Thongchai (2006) observed increases in strength upon adding up to 4% concentrations of dihydrate gypsum ($\text{CaSO}_4 \cdot 2\text{H}_2\text{O}$) to a lime and flyash treated silty clay. The authors attributed the increase in strength to formation of large agglomerates, mostly calcium aluminosilicate hydrates, which acted as bonding agents between clay particles and pozzolanic products. No formation of ettringite was detected in the samples despite the addition of gypsum.

This paper summarizes the work carried out for the treatability study of SRM, associated with the remediation of contaminated soils in a disused petrol filling station in Kent, UK. The results of several phases of intrusive investigations and a detailed quantitative risk assessment, carried out for the site, indicated that petroleum hydrocarbon compounds in the soils presented a significant risk to human health receptors, via inhalation of vapours and direct exposure and to groundwater receptors. A remediation strategy was designed to result in reducing the total soil and leachate concentrations of the hydrocarbon compounds, to minimize the risks to both human health and groundwater receptors. In addition, an improvement of the strength was required in order to increase bearing capacity of the foundation soils for future development of the site. In-situ SRM was selected as the optimum technology to achieve both the environmental and geotechnical goals associated with a residential redevelopment of the site. As a part of the evaluation of feasibility of SRM, a number of binder reagents, including quicklime, hydrated lime and ordinary Portland cement, were tested. Furthermore, the addition of Gypsum to some reagent formulations was evaluated in an attempt to improve the strength of the binder/soil mixes.

A number of contaminated clay samples were taken from the site and blended together. The homogenised sample was mixed in the laboratory with different formulations of binder reagents and left to cure under laboratory environmental conditions. Concentrations of petroleum hydrocarbon compounds were determined on soil and leachate samples after a 28-day curing period. The effects of temperature on the mechanisms responsible for concentration reduction of petroleum hydrocarbons were evaluated by comparing the use of quicklime with that of hydrated lime and OPC slurries, which have less pronounced exothermic reactions. Changes in the physical and physico-chemical properties of the soil were quantified by examining pH, moisture content, liquid limit and plastic limit changes over the 28 day testing program. The unconfined compressive strength of the treated clay was measured on samples which had been compacted immediately after reagent mixing and left to cure in submerged condition in distilled water baths for 28 days.

2. MATERIALS AND METHODS

2.1 Materials

Natural samples of a clayey soil were taken from five trial pits, excavated in previously identified contaminated areas of a disused petrol filling station in Kent, UK. Soil samples taken from the trial pits were placed in double polyethylene bags and brought immediately to the Arcadis laboratory, where concentrations of Benzene, Toluene, Ethylbenzene and Xylenes (BTEX) were immediately measured to confirm that the samples taken were contaminated. The samples were then stored overnight in double polyethylene bags placed in sealed plastic containers. A number of contaminated soil samples were then selected, the gravel size constituents removed and the samples mixed together, using first a stainless steel spatula on a glass plate, and then a 2-inch pugmill mechanical mixer to produce a homogeneous sample. Moisture content, Atterberg limits, pH, total sulphate, Total Organic Carbon (TOC) and Loss on Ignition (LOI) of the homogenized sample were determined and are presented in Table 1. The untreated homogenized clay sample had a moisture content ranging between 33% and 34%, liquid limit ranging between 49% and 52% and plastic limit between 25% and 26%.

The homogenized clay was mixed with a number of binder reagents including quicklime, hydrated lime and ordinary Portland cement. The quicklime powder (Lhoist UK) used in the experiments contained at least 97% calcium oxide and small quantities of calcium carbonate, magnesia and trace elements. The hydrated lime powder (Lhoist UK) contained at least 92% calcium hydroxide and small quantities of calcium carbonate, magnesia and trace elements. Agricultural grade Gypsum (British Gypsum) was added to some reagent formulations in an attempt to improve the strength of the binder/soil mix. The gypsum contained 98% calcium sulfate dihydrated ($\text{CaSO}_4 \cdot 2\text{H}_2\text{O}$) and a minor amount of calcium carbonate and clay impurities. All the reagents were stored in sealed plastic containers at room temperature prior to be mixed with the soils.

Table 1. Soil Properties in Untreated and Treated Samples

| | Time Days | Untreated | QL ₂₀ | QL ₁₀ G ₁₀ | HL ₂₀ | HL ₁₀ C ₁₀ | HL ₁₀ C ₅ G ₅ | C ₂₀ | C ₁₀ G ₁₀ |
|------------------------|-----------|-----------|------------------|----------------------------------|------------------|----------------------------------|--|-----------------|---------------------------------|
| w (%) | t=0 | 33-34 | 18.3 | 25.6 | 35.7 | 34.6 | 36.8 | 35.3 | 38.0 |
| | t=28 | 32.0 | 17.8 | 25.6 | 35.9 | 33.9 | 36.0 | 31.9 | 36.1 |
| w _l (%) | t=0 | 49-52 | 48 | 53 | 60 | 66 | 65 | 61 | 66 |
| | t=28 | na | 43 | 53 | 58 | 57 | 64 | 59 | 65 |
| w _p (%) | t=0 | 25-26 | 34 | 35 | 31 | 35 | 42 | 44 | 42 |
| | t=28 | na | 35 | 37 | 36 | 44 | 45 | 46 | 45 |
| PI | t=0 | 24-26 | 14 | 18 | 29 | 31 | 23 | 17 | 24 |
| | t=28 | na | 8 | 16 | 22 | 13 | 19 | 13 | 20 |
| pH | t=0 | 7.9 | | | | | | | |
| | t=28 | 9.3 | 12.7 | 12.6 | 12.6 | 12.6 | 12.6 | 12.6 | 12.1 |
| Total Sulphate (mg/kg) | t=0 | 0.78 | na | na | na | Na | na | na | na |
| | t=28 | 1.16 | 2.44 | 47.18 | 1.12 | 4.37 | 22.15 | 6.30 | 55.32 |
| TOC (%) | t=0 | 0.91 | na | na | na | Na | na | na | na |
| | t=28 | 0.97 | 0.68 | 0.53 | 0.58 | 0.74 | 0.83 | 0.84 | 0.76 |
| LOI (%) | t=0 | 2.9 | na | na | na | Na | na | na | na |
| | t=28 | 3.0 | 2.4 | 1.8 | 2.9 | 1.6 | 2.0 | 3.3 | 3.0 |
| UCS (kPa) | t=28 | 46 | 141 | 484 | 90 | 395 | 524 | 1186 | 687 |
| γ (Mg/m ³) | t=28 | 1.89 | 1.67 | 1.84 | 1.80 | 1.81 | 1.80 | 1.77 | 1.79 |

Notes: Untreat. = Untreated; t=0 = immediately after mixing; w = moisture content; w_l = liquid limit, w_p = plastic limit, PI = Plasticity Index; ppm = parts per million; UCS = Unconfined Compressive Strength; γ = bulk density; na = test not undertaken.

2.2 Methods

The experimental work was carried out in the laboratories of Arcadis Geraghty and Miller International (Arcadis GMI), Newmarket, UK. Chemical analyses were carried out by ALcontrol Geochem (Chester, UK) and undrained shear strength tests by Soil Property Testing (Huntington, UK), both UKAS accredited commercial laboratories. Preliminary chemical analyses on BTEX compounds were carried out in the Arcadis mobile analytical laboratory.

Moisture content, liquid and plastic limit of soils were determined using the BS1377:1990 Part 2(3), 2(4.4) and 2(5) methods (BSI, 1990). The liquid limit was determined using the one-point cone penetrometer test. Moisture contents were determined on duplicate samples. Temperatures were measured by inserting a digital thermometer (Electronic Temperature Instruments Ltd) into the soil samples. Evolution of Volatiles Organic Compounds (VOCs) during laboratory mixing of soil and reagents was detected using a hand-held Photo-Ionisation Detector (PID) (RAE Systems, miniRAE 2000).

Soil samples were placed in standard sealed glass jars and sent, inside coolboxes, with ice packs to ALcontrol Geochem Laboratory for the chemical analyses immediately after reagent mixing. The samples received by the laboratory were stored at 4 °C and tested within 24 hours of receipt. Total Petroleum Hydrocarbon Working Group compounds (TPH) and 16 speciated Polynuclear Aromatic Hydrocarbon (PAH) analyses were carried out. TPH as measured, according to the Total Petroleum Hydrocarbon Working Group, is split between aliphatic and aromatic hydrocarbon species and banded by carbon number. The aliphatic hydrocarbons generally have lower volatility than the aromatic hydrocarbons and require the use of an extraction method to prepare for analysis. The aromatic range compounds, typically found in gasoline and are extracted by using a volatilization method. The Gasoline Range Hydrocarbons (GRO) (C4-C10), including benzene, toluene, ethylbenzene, xylenes (BTEX) and MTBE, concentrations were determined by Gas Chromatography - Flame Ionization Detection using a method based on US EPA Methods 8021b (USEPA, 1996a) and 602 (USEPA, 1984); the Extractable Petroleum Hydrocarbon (EPH) (C10-C40) concentrations by Gas Chromatography - Flame Ionization Detection Massachusetts Department of Environmental Protection, 1998 Method (Massachusetts Department of Environmental Protection, 2003); the PAH by Gas Chromatography – Mass Spectrometry US EPA Method 8100 (USEPA, 1996b). EPHs and PAHs were extracted using Accelerated Solvent Extraction system (ASE) followed by solvent reduction using a Zymark Turbovap. The soluble organics were extracted from the soil sample using Hexane as the solvent.

Leachates were extracted from soil samples using the National Rivers Authority (NRA) leaching test (Lewin et al., 1994). The soil samples were left to stand in a slurry state (water to solid ratio 10:1) for 24 hours inside new sterilized glass vessels with polytetrafluoroethylene (PTFE) lids. Distilled/deionised water with a pH of 5.6 was used to prepare the slurry samples. The slurry samples were filtered and centrifuged and the extract water submitted for further analyses. Glass fiber filters (Whatman 1.6µm) and centrifuge glass vials, with PTFE lids, were used to minimize adsorption of hydrocarbons. All vials and vessels were discarded after use.

The QA/QC procedures for the analytical methods used in this study consisted of the standard ALcontrol laboratories QA/QC procedures, that is one reagent-blank leachate sample was analyzed for every 20 leachate samples, one certificate reference material tests and one reagent-blank test were analyzed for every 20 soil samples.

Unconfined compression tests were carried out on compacted untreated and treated samples. The samples were compacted inside 75mm diameter, 6.35mm thick wall PVC cells using a Standard Proctor Hammer. The soils were compacted in three layers to produce 150 mm long samples. The compaction procedure was modified with respect to BS1377-4:1990 (BSI, 1990) to account for the different compaction mould area with respect to standard Proctor tests. The number of blows for each layer was computed in such a way as to deliver the same compaction energy as in the standard Proctor test. The samples were then left to cure under tap water for 28 days before being submitted to Soil Property Testing laboratory for Unconfined Compressive Strength (UCS) Testing. UCS tests were carried out using the BS1377:1990 Part 7(7) method (BSI, 1990).

2.3 Preparation of Samples

The homogenized clay sample was mixed in the laboratory with the selected reagent formulations. Initially, the mixing was carried out by hand using a stainless steel spatula on a glass plate. During this stage, temperature and evolution of VOCs were monitored. After approximately 30 minutes of hand mixing, the soils were passed through a 2-inch pugmill mechanical mixer. Seven different reagent formulations were used in this study, including single and multiple reagent formulations. The amount of reagents in terms of soil dry weight basis (w/w) were: 20% quicklime (sample QL₂₀), 10% quicklime and 10% gypsum (sample QL₁₀/G₁₀), 20% hydrated lime (sample HL₂₀), 10% hydrated lime and 10% cement (sample HL₁₀C₁₀), 10% hydrated lime, 5% cement and 5% gypsum (sample HL₁₀C₅G₅), 20% cement (C₂₀) and 10% cement and 10% gypsum (sample C₁₀G₁₀). The binder reagents formulations used in the experiments and the resulting treated samples are summarized in Table 2.

Table 2. Treated Samples: Reagent Formulations

| Reagent (%) | QL ₂₀ | QL ₁₀ G ₁₀ | HL ₂₀ | HL ₁₀ C ₁₀ | HL ₁₀ C ₅ G ₅ | C ₂₀ | C ₁₀ G ₁₀ |
|---------------|------------------|----------------------------------|------------------|----------------------------------|--|-----------------|---------------------------------|
| Quicklime | 20 | 10 | - | - | - | - | - |
| Hydrated Lime | - | - | 20 | 10 | 10 | - | - |
| OPC | - | - | - | 10 | 5 | 20 | 10 |
| Gypsum | - | 10 | - | - | 5 | - | 10 |
| Water | - | - | 10 | 10 | 10 | 10 | 10 |

Dry quicklime and gypsum were added to the soil as powders in the preparation of samples QL₂₀ and QL₁₀G₁₀; all other reagent formulations were added as slurries, using an amount of distilled water corresponding to an increase of soil moisture of 10%, in terms of soil dry weight basis (w/w). After mixing, a portion of the soil-binders mixtures were stored in sealed polyethylene containers in the laboratory, at natural moisture and temperature conditions for 28 days. The untreated clay sample was stored for control purposes. The untreated and treated samples were placed in sealed glass jars with coolboxes, provided with ice packs and sent to ALcontrol Geochem Laboratory for the chemical analyses. The samples received by the laboratory were stored at 4 °C and tested within 24 hours from receipt.

Approximately 24 hours after mixing the binder reagents, the samples of the soil-binders mixtures were compacted inside 75mm diameter PVC cells. Prior to placing the soils, a layer of silicone grease was spread on the wall of the cells in order to minimize friction during the subsequent extrusion of the samples. After compaction, the samples were left in the cells and placed into polyethylene containers, where they were loaded using steel discs placed on the soil samples. Discs of geotextile material were placed between the soil and the steel disc. The load applied corresponded approximately to the computed average effective overburden stress in the zone of expected in-situ treatment. The containers were then filled with tap water to allow the loaded samples to cure in wet conditions. After 28 days curing the samples were unloaded and submitted inside the cells to the laboratory for extrusion and determination of unconfined compressive strength (UCS).

3. RESULTS

3.1 Temperature and PID measurements during mixing

Temperature and PID readings were intermittently monitored during hand mixing the binder reagents and the clay. Noticeable temperature increases were observed in the samples mixed with powdered quicklime. Temperature increases for all other samples were minimal. The differences in maximum temperatures in the different samples can be explained in terms of the exothermic hydration reaction taking place during mixing of dry quicklime, as opposed to limited hydration reactions during

the mixing of cement, gypsum and hydrated lime slurries to soil. Maximum temperatures measured during mixing are presented in Table 3.

Table 3. Temperature measurements and PID readings during mixing

| | QL ₂₀ | QL ₁₀ G ₁₀ | HL ₂₀ | HL ₁₀ C ₁₀ | HL ₁₀ C ₅ G ₅ | C ₂₀ | C ₁₀ G ₁₀ |
|--------------------------|------------------|----------------------------------|------------------|----------------------------------|--|-----------------|---------------------------------|
| T _o | 9.6 | 10 | 10 | na | 10 | 12 | na |
| T _{max} (°C) | 70 | 26 | 13 | 15 | 15 | 14 | 16 |
| PID _{max} (ppm) | 84 | 249 | 213 | na | 9.5 | 1.5 | na |
| | 163 | 246 | 631 | 167 | 24.6 | 63 | 36.1 |

The maximum temperatures recorded were: 70°C (QL₂₀), 26°C (QL₁₀G₁₀), 13°C (HL₂₀), 15°C (HL₁₀C₁₀), 15°C (HL₁₀C₅G₅), 14°C (C₂₀) and 16°C (C₁₀G₁₀).

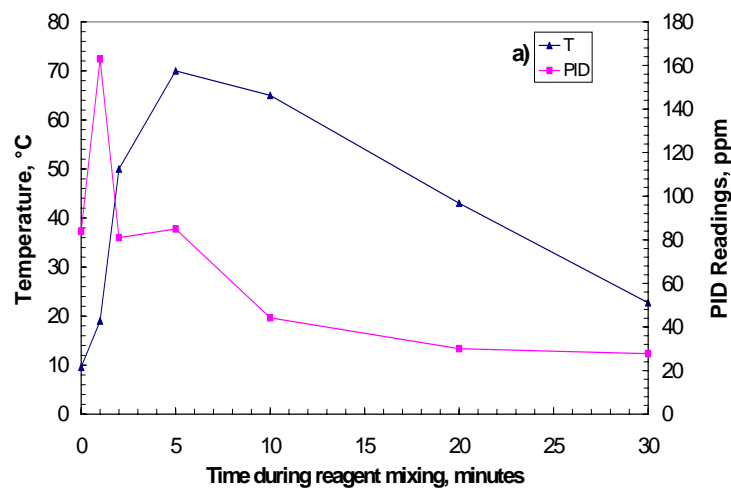

Figure 1.

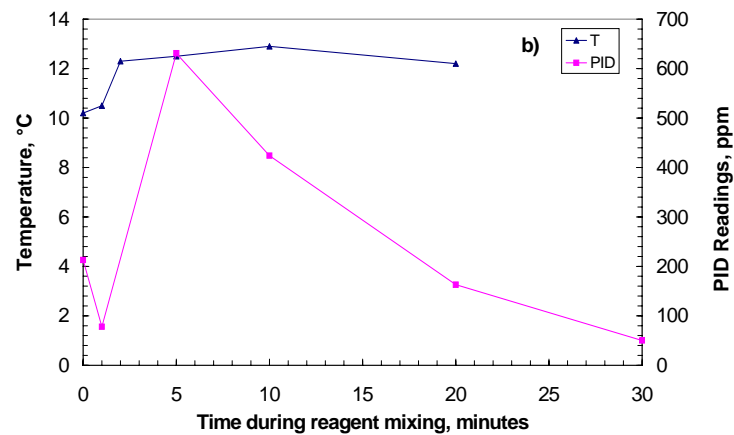

Figure 1. Temperatures and PID readings during mixing of samples a) QL₂₀ and b) HL₂₀

As shown in Figure 1, in sample QL₂₀ the temperature was observed to increase rapidly during the first few minutes of mixing, then reached a maximum value and eventually gradually decreased. High

values of PID readings were obtained during the soil mixing before and after adding the binder reagents (Figure 1a). As shown in Figure 1, a progressive decrease in the values of PID readings was observed as the reagent mixing progressed.

3.2 Physical, Physico-Chemical and Mechanical Properties

Changes in the physical and physico-chemical properties of the soil upon reagent mixing were quantified by examining pH, moisture content, liquid limit and plastic limit changes over the 28 day testing program.

The pH of treated samples was measured after 28 days curing. Results of pH measurements are presented in Table 1. A significant increase in pH upon binder reagent mixing was observed in all samples. Moisture content, liquid limit and plastic limit were determined on the clay immediately after adding the reagents and after 28 days of curing. The results are presented in Table 1. These show that immediately after mixing, the liquid limit slightly decreased in sample QL₂₀, slightly increased in QL₁₀G₁₀ and significantly increased in all other samples. The liquid limit determined after a 28-day curing period are smaller than the values immediately after mixing, indicating a decreasing trend of liquid limit with time.

Plastic limit immediately increased in all samples and continued to increase during the 28 days curing period. Considering that the addition of the binder reagent slurries increased the moisture content of the samples by 10%, with respect to the untreated clay moisture content, it can be concluded that the addition of binders resulted in a decrease in moisture content in all the samples. The moisture content continued to decrease with time, as indicated by the 28 day curing measurements.

The UCS of the untreated clay in a remolded condition, and of the treated samples, was determined after 28 days of wet curing inside the PVC compaction cells. The results are presented in Table 1 and Figure 2. An "Estimated Undisturbed" strength value is also presented in Figure 2. This was computed on the basis of the empirical relationship between liquidity index and sensitivity of the clay (Terzaghi et al., 1996). It can be observed that increases in UCS with respect to the clay remolded UCS were achieved in all treated samples. Particularly significant increases in UCS were observed in samples C₂₀, C₁₀G₁₀, HL₁₀C₅G₅, QL₁₀G₁₀ and HL₁₀C₁₀.

As for practical reasons a total amount of reagents and gypsum of 20% was selected for all samples. A full assessment on the effect of adding gypsum on the strength of the binder treated soils is not possible. However, comparisons of samples QL₂₀ and QL₁₀G₁₀, HL₁₀C₁₀ and HL₁₀C₅G₅ and C₂₀ and C₁₀G₁₀ suggest that adding gypsum appears to have favorable effects on the strength of soils treated with a predominantly lime based reagent formulation, and less favorable effects on that of cement based formulations.

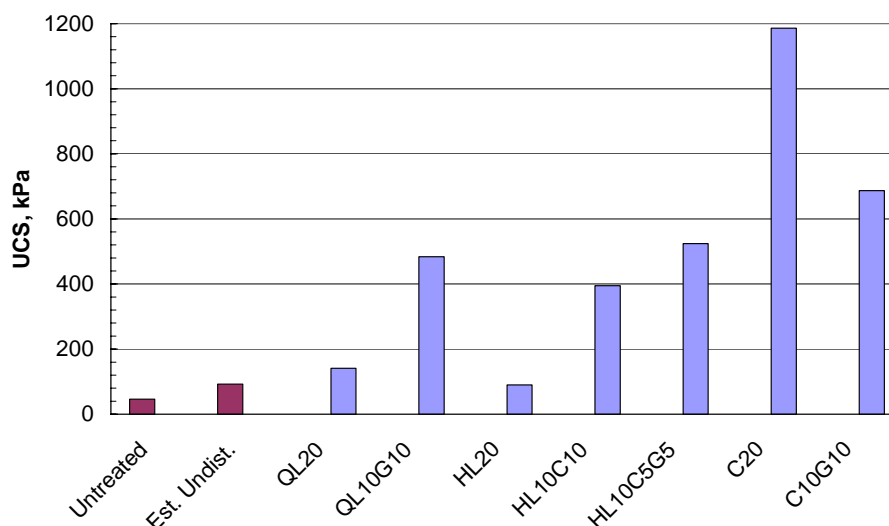

Figure 2. Unconfined Compressive Strength of Treated and Untreated Samples

3.3 Concentrations of Petroleum Hydrocarbons

3.3.1 Total Soil Concentrations

Concentrations of BTEX, MTBE, TPH and PAH measured in the untreated clay and in the clay samples after 28 day curing time are presented in Table 4 and Table 5. The concentrations of BTEX, MTBE and TPH measured in sample HL₁₀C₅G₅ are also presented in Figure 3. All treated samples present significantly smaller concentrations of BTEX, MTBE and all ranges of Total Petroleum Hydrocarbons TPH working groups than the untreated sample. Particularly significant decreases in concentrations of BTEX and light aliphatic (>C₅-C₁₂) and aromatic (>EC₈-EC₁₆) compounds were observed in all treated samples.

The percent decrease of GRO (C₄-C₁₂) concentrations in the treated samples ranged between 97% and 99.8%, that of TPH between 80% and 91%. Some increases in concentrations of heavy aliphatics were observed in samples QL₁₀G₁₀ (>C₁₆-C₃₅), C₂₀ and C₁₀G₁₀ (>C₂₁-C₃₅). A slight increase in the concentration of aromatics range >EC₂₁-EC₃₅ was also observed in sample HL₁₀C₁₀.

Concentrations of PAH compounds also generally decreased upon treatment with binder reagents. Significant concentration reductions were observed for the rather volatile naphthalene, whereas negligible changes or even small increases, with respect to the untreated clay, were observed for a number of PAH compounds in sample C₁₀G₁₀ and for heavier compounds, such as benzo(a)pyrene and benzo(b)fluoranthene in a number of samples.

Table 4. Concentrations in mg/kg of Speciated Total Petroleum Hydrocarbon (TPH), BTEX/MTBE compounds in untreated and treated samples

| Sample Identity | Untreated | QL ₂₀ | QL ₁₀ G ₁₀ | HL ₂₀ | HL ₁₀ C ₁₀ | HL ₁₀ C ₅ G ₅ | C ₂₀ | C ₁₀ G ₁₀ |
|--|-----------|------------------|----------------------------------|------------------|----------------------------------|--|-----------------|---------------------------------|
| GRO (C ₄ -C ₁₂) | 495.65 | 2.17 | 1.27 | 14.87 | 2.10 | 0.96 | 0.96 | 2.03 |
| MTBE | 38.72 | <0.01 | <0.01 | <0.01 | <0.01 | <0.01 | <0.01 | <0.01 |
| Benzene | 6.78 | 0.02 | 0.03 | 0.04 | 0.03 | 0.03 | 0.02 | 0.02 |
| Toluene | 47.68 | 0.06 | 0.06 | 0.28 | 0.08 | 0.06 | 0.06 | 0.05 |
| Ethyl benzene | 20.80 | 0.02 | <0.01 | 0.08 | 0.03 | <0.01 | <0.01 | <0.01 |
| m & p Xylene | 75.13 | 0.12 | 0.09 | 0.29 | 0.13 | 0.12 | 0.10 | 0.09 |
| o Xylene | 32.55 | 0.07 | 0.04 | 0.22 | 0.06 | 0.06 | 0.05 | 0.04 |
| Aliphatics C ₅ -C ₆ | 3.26 | <0.01 | <0.01 | <0.01 | <0.01 | <0.01 | <0.01 | <0.01 |
| Aliphatics >C ₆ -C ₈ | 110.83 | <0.01 | <0.01 | 2.48 | <0.01 | <0.01 | <0.01 | <0.01 |
| Aliphatics >C ₈ -C ₁₀ | 41.78 | 0.21 | 0.08 | 1.51 | 0.15 | 0.07 | 0.06 | 0.15 |
| Aliphatics >C ₁₀ -C ₁₂ | 22.18 | 0.54 | 0.34 | 3.08 | 0.56 | 0.21 | 0.23 | 0.58 |
| Aliphatics >C ₁₂ -C ₁₆ | 37.30 | 9.13 | 13.69 | 15.59 | 14.90 | 10.73 | 25.74 | 16.53 |

| Sample Identity | Untreated | QL ₂₀ | QL ₁₀ G ₁₀ | HL ₂₀ | HL ₁₀ C ₁₀ | HL ₁₀ C ₅ G ₅ | C ₂₀ | C ₁₀ G ₁₀ |
|-------------------------|-----------|------------------|----------------------------------|------------------|----------------------------------|--|-----------------|---------------------------------|
| Aliphatics >C16-C21 | 17.38 | 10.76 | 21.06 | 13.66 | 15.46 | 13.12 | 38.36 | 19.17 |
| Aliphatics >C21-C35 | 9.56 | 5.70 | 12.04 | 7.43 | 9.58 | 5.43 | 9.00 | 6.92 |
| Total Aliphatics C5-C35 | 242.29 | 26.34 | 47.21 | 43.75 | 40.65 | 29.55 | 73.38 | 43.35 |
| Aromatics >EC8-EC10 | 191.15 | 0.53 | 0.25 | 2.86 | 0.45 | 0.28 | 0.25 | 0.36 |
| Aromatics >EC10-EC12 | 33.27 | 0.81 | 0.51 | 4.62 | 0.84 | 0.31 | 0.34 | 0.86 |
| Aromatics >EC12-EC16 | 4.17 | 1.54 | <0.01 | 1.82 | <0.01 | 0.21 | 1.41 | 0.77 |
| Aromatics >EC16-EC21 | 8.95 | 6.47 | 3.28 | 7.42 | 4.73 | 3.43 | 5.63 | 7.07 |
| Aromatics >EC21-EC35 | 33.03 | 26.34 | 22.17 | 22.09 | 35.96 | 16.72 | 31.10 | 28.78 |
| Total Aromatics C6-C35 | 325.03 | 35.77 | 26.30 | 39.13 | 42.09 | 21.04 | 38.81 | 37.92 |
| TPH | 567.32 | 62.11 | 73.51 | 82.88 | 82.74 | 50.58 | 112.18 | 81.26 |

3.3.2 Hydrocarbons Concentrations in Leachates

No standardized leaching tests for organic compounds are available at present (Hansen et al., 2004; Wiles and Barth, 1992). Batch leaching tests, such as NRA test, were originally developed to assess leachability of metals from a solid matrix. A quantitative interpretation of batch leach tests for organic compounds is complicated by a number of relatively unknown factors, such as effects of suspended matter, dissolved organic matter and other colloidal particles. Therefore, results of leaching tests were used to qualitatively assess the mass transfer to porewater of petroleum hydrocarbons in the soil samples treated with binder reagents.

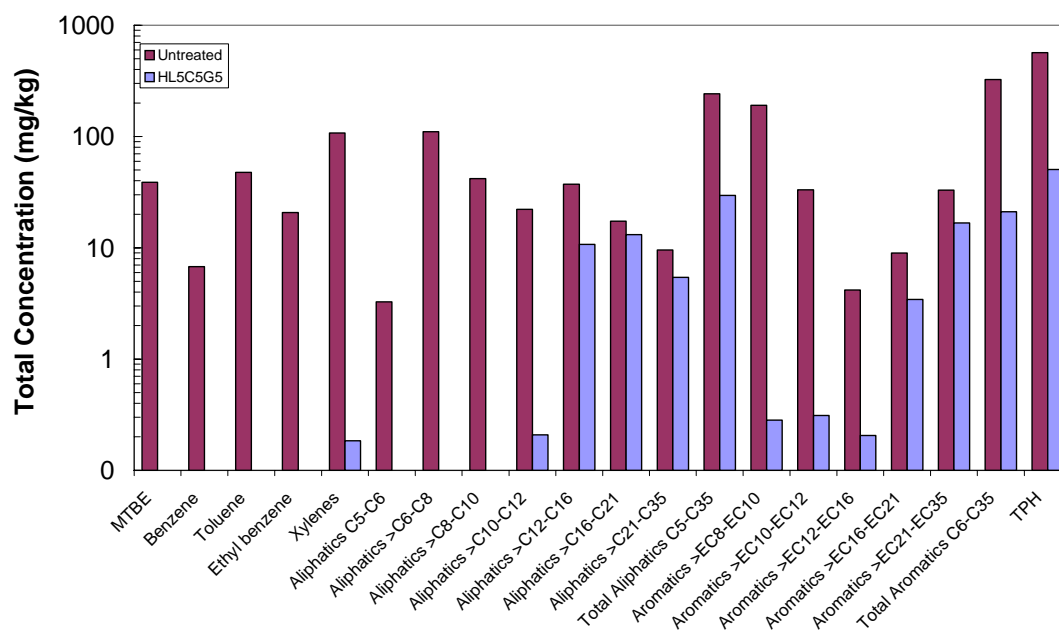

Figure 3. Concentrations of Speciated Total Petroleum Hydrocarbon (TPH), BTEX/ MTBE compounds in untreated clay and in sample HL₁₀C₅G₅.

Petroleum hydrocarbon concentrations were measured in the leachates extracted from the untreated sample and from the treated samples after 28 day curing time.

The concentrations of BTEX, MTBE, TPH and PAH compounds measured in the leachates are presented in Tables 6 and 7. The concentrations of hydrocarbons measured in the leachates from the treated samples are generally substantially smaller than those from the untreated sample. The percent decrease of GRO (C4-C12) concentrations in the treated samples ranged between 96% and 100%, that of TPH between 95% and 100%. Slight increases of fluorene and phenanthrene concentrations in leachates from treated samples were observed in a number of samples.

4. DISCUSSION

The mixing of the petroleum hydrocarbons contaminated clay with single or multi-component formulations of binder reagents resulted in a decrease in total soil concentration of petroleum hydrocarbons. A comparison of leaching test results between the untreated and treated clay, together with the results of total soil concentration, demonstrates that the binder reagent mixing resulted also in a decrease of mass transfer of petroleum hydrocarbons.

Table 5. Concentrations in mg/kg of Speciated Polynuclear Aromatic Hydrocarbons (PAH) in untreated and treated samples

| Sample Identity | Untreated | QL ₂₀ | QL ₁₀ G ₁₀ | HL ₂₀ | HL ₁₀ C ₁₀ | HL ₁₀ C ₅ G ₅ | C ₂₀ | C ₁₀ G ₁₀ |
|-----------------------|-----------|------------------|----------------------------------|------------------|----------------------------------|--|-----------------|---------------------------------|
| Naphthalene | 4.55 | 0.19 | 0.16 | 0.19 | 0.23 | 0.21 | 0.17 | 0.32 |
| Acenaphthylene | 0.06 | 0.05 | 0.05 | 0.05 | 0.05 | 0.04 | 0.04 | 0.05 |
| Acenaphthene | 0.31 | 0.10 | 0.10 | 0.09 | 0.09 | 0.05 | 0.06 | 0.18 |
| Fluorene | 0.56 | 0.21 | 0.26 | 0.20 | 0.19 | 0.14 | 0.15 | 0.36 |
| Phenanthrene | 2.01 | 1.27 | 1.44 | 1.27 | 1.17 | 0.97 | 0.97 | 1.93 |
| Anthracene | 0.34 | 0.29 | 0.33 | 0.28 | 0.26 | 0.22 | 0.19 | 0.46 |
| Fluoranthene | 2.33 | 1.80 | 1.97 | 1.68 | 1.69 | 1.50 | 1.33 | 2.51 |
| Pyrene | 1.78 | 1.50 | 1.50 | 1.30 | 1.38 | 1.14 | 1.11 | 2.06 |
| Benz(a)anthracene | 0.79 | 0.69 | 0.76 | 0.62 | 0.70 | 0.66 | 0.56 | 0.95 |
| Chrysene | 0.83 | 0.68 | 0.74 | 0.61 | 0.69 | 0.66 | 0.56 | 0.93 |
| Benzo(b)fluoranthene | 1.00 | 1.07 | 1.27 | 1.06 | 0.91 | 1.32 | 1.00 | 1.33 |
| Benzo(k)fluoranthene | 0.35 | 0.31 | 0.43 | 0.30 | 0.31 | 0.30 | 0.22 | 0.45 |
| Benzo(a)pyrene | 0.61 | 0.57 | 0.64 | 0.54 | 0.62 | 0.61 | 0.52 | 0.84 |
| Indeno(123cd)pyrene | 0.37 | 0.32 | 0.32 | 0.27 | 0.37 | 0.31 | 0.27 | 0.42 |
| Dibenzo(ah)anthracene | 0.18 | 0.08 | 0.11 | 0.07 | 0.08 | 0.09 | 0.09 | 0.13 |
| Benzo(ghi)perylene | 0.41 | 0.32 | 0.36 | 0.31 | 0.38 | 0.35 | 0.31 | 0.45 |
| PAH 16 Total | 16.47 | 9.42 | 10.42 | 8.83 | 9.11 | 8.56 | 7.52 | 13.34 |

The decrease of total soil concentrations of light hydrocarbons can be partly explained in terms of volatilization during the mixing process, as suggested by the large PID readings in Table 1 and Figure 1. A comparison of Figure 1 a and b suggests that the rate and magnitude of volatiles release during the soil mixing process is mainly related to the mechanical mixing action and possibly, in the case of quicklime reagent, in part to temperature effects. Other mechanisms responsible for the decreases in concentrations of volatiles could be the mixing at a molecular level of a portion of the compounds with the clay / pozzolanic products matrix, as observed by Butler et al. (2000) and Nestle et al (2001) for Toluene in cement matrices.

Table 6. Concentrations in µg/l of Speciated Total Petroleum Hydrocarbon (TPH), BTEX/MTBE compounds in leachate samples

| Sample Identity | Untreated | QL ₂₀ | QL ₁₀ G ₁₀ | HL ₂₀ | HL ₁₀ C ₁₀ | HL ₁₀ C ₅ G ₅ | C ₂₀ | C ₁₀ G ₁₀ |
|-------------------------|-----------|------------------|----------------------------------|------------------|----------------------------------|--|-----------------|---------------------------------|
| GRO (C4-C12) | 28912 | <10 | <10 | 1270 | <10 | <10 | <10 | <10 |
| MTBE | 614 | <10 | <10 | <10 | <10 | <10 | <10 | <10 |
| Benzene | 158 | <10 | <10 | <10 | <10 | <10 | <10 | <10 |
| Toluene | 2158 | <10 | <10 | <10 | <10 | <10 | <10 | <10 |
| Ethyl benzene | 1138 | <10 | <10 | <10 | <10 | <10 | <10 | <10 |
| m & p Xylene | 3095 | <10 | <10 | <10 | <10 | <10 | <10 | <10 |
| o Xylene | 1826 | <10 | <10 | <10 | <10 | <10 | <10 | <10 |
| Aliphatics C5-C6 | <10 | <10 | <10 | <10 | <10 | <10 | <10 | <10 |
| Aliphatics >C6-C8 | 5974 | <10 | <10 | 15 | <10 | <10 | <10 | <10 |
| Aliphatics >C8-C10 | 3403 | <10 | <10 | 136 | <10 | <10 | <10 | <10 |
| Aliphatics >C10-C12 | 2176 | <10 | <10 | 366 | <10 | <10 | <10 | <10 |
| Aliphatics >C12-C16 | 307 | <10 | <10 | <10 | <10 | <10 | <10 | <10 |
| Aliphatics >C16-C21 | 186 | <10 | <10 | <10 | <10 | <10 | <10 | <10 |
| Aliphatics >C21-C35 | 204 | <10 | <10 | <10 | <10 | <10 | <10 | <10 |
| Total Aliphatics C5-C35 | 12250 | <10 | <10 | 517 | <10 | <10 | <10 | <10 |
| Aromatics >EC8-EC10 | 11164 | <10 | <10 | 204 | <10 | <10 | <10 | <10 |
| Aromatics >EC10-EC12 | 3265 | <10 | <10 | 549 | <10 | <10 | <10 | <10 |
| Aromatics >EC12-EC16 | 136 | 26 | 82 | 222 | 63 | 57 | 62 | 61 |

| Sample Identity | Untreated | QL ₂₀ | QL ₁₀ G ₁₀ | HL ₂₀ | HL ₁₀ C ₁₀ | HL ₁₀ C ₅ G ₅ | C ₂₀ | C ₁₀ G ₁₀ |
|------------------------|-----------|------------------|----------------------------------|------------------|----------------------------------|--|-----------------|---------------------------------|
| Aromatics >EC16-EC21 | 172 | 25 | 51 | 55 | 29 | 42 | 44 | 33 |
| Aromatics >EC21-EC35 | 308 | <10 | <10 | <10 | <10 | <10 | <10 | <10 |
| Total Aromatics C6-C35 | 17361 | 51 | 133 | 1030 | 92 | 99 | 106 | 94 |
| TPH | 29611 | 51 | 133 | 1547 | 92 | 99 | 106 | 94 |

The magnitude of concentration decreases of the heavy aliphatic and aromatics were similar for quicklime treated samples, for which large temperature increases were measured during reagent mixing, and other samples where negligible increases in temperature were measured. Therefore, it can be concluded that temperature effects do not play a major role in the decreases in concentrations of heavy aliphatics and aromatics in the clay samples.

The decreases in concentration of the heavy aliphatic and aromatics can be explained in terms of a strong association between the petroleum hydrocarbon compounds and the solid constituents of the samples.

Table 7. Concentrations in mg/kg of Speciated Polyneuclear Aromatic Hydrocarbons (PAH) in leachate samples

| Sample Identity | Untreated | QL ₂₀ | QL ₁₀ G ₁₀ | HL ₂₀ | HL ₁₀ C ₁₀ | HL ₁₀ C ₅ G ₅ | C ₂₀ | C ₁₀ G ₁₀ |
|-----------------------|-----------|------------------|----------------------------------|------------------|----------------------------------|--|-----------------|---------------------------------|
| Naphthalene | 233.79 | 19.29 | 19.47 | 78.21 | 24.78 | 15.59 | 17.93 | 17.20 |
| Acenaphthylene | 0.57 | 0.17 | 0.28 | 0.52 | 0.19 | 0.17 | 0.15 | 0.17 |
| Acenaphthene | 3.27 | 3.43 | 3.50 | 6.17 | 2.82 | 2.97 | 2.64 | 2.84 |
| Fluorene | 4.26 | 5.71 | 6.28 | 8.84 | 4.60 | 5.60 | 4.45 | 4.67 |
| Phenanthrene | 12.52 | 12.17 | 14.89 | 17.29 | 9.74 | 11.55 | 10.83 | 11.29 |
| Anthracene | 3.23 | 2.26 | 2.88 | 3.35 | 1.80 | 2.12 | 2.12 | 2.20 |
| Fluoranthene | 10.63 | 3.19 | 4.56 | 4.55 | 2.62 | 3.20 | 3.57 | 3.81 |
| Pyrene | 8.27 | 2.03 | 3.01 | 2.95 | 1.71 | 2.08 | 2.34 | 2.48 |
| Benz(a)anthracene | 3.18 | 0.13 | 0.23 | 0.20 | 0.11 | 0.14 | 0.15 | 0.17 |
| Chrysene | 2.43 | 0.13 | 0.22 | 0.21 | 0.12 | 0.15 | 0.18 | 0.19 |
| Benzo(b)fluoranthene | 1.31 | <0.01 | <0.01 | 0.03 | <0.01 | <0.01 | <0.01 | <0.01 |
| Benzo(k)fluoranthene | 1.65 | <0.01 | <0.01 | 0.04 | <0.01 | <0.01 | <0.01 | <0.01 |
| Benzo(a)pyrene | 1.88 | <0.01 | <0.01 | 0.04 | <0.01 | <0.01 | <0.01 | <0.01 |
| Indeno(123cd)pyrene | 0.64 | <0.01 | <0.01 | <0.01 | <0.01 | <0.01 | <0.01 | <0.01 |
| Dibenzo(ah)anthracene | 0.26 | <0.01 | <0.01 | <0.01 | <0.01 | <0.01 | <0.01 | <0.01 |
| Benzo(ghi)perylene | 0.94 | <0.01 | <0.01 | <0.01 | <0.01 | <0.01 | <0.01 | <0.01 |
| PAH 16 Total | 288.80 | 48.50 | 55.31 | 122.39 | 48.47 | 43.55 | 44.38 | 45.01 |

This would hinder their extraction and determination by the analytical procedure used. Permanent conversion of long chains hydrocarbons into volatile compounds, which evaporate into the atmosphere (Soundararajan, 1992), or degradation of the compounds, possibly due to chemical or electrochemical oxidation processes, would also account for the decrease in concentrations. The association mechanism may be explained in terms of encapsulation of hydrocarbons within the clay particles macroaggregates, produced by the clay / quicklime / porewater reactions. The progressive hardening of the pozzolanic products hinders the release of the compounds in the porewater. The hypothesized encapsulation mechanism appears to be substantiated by the changes in physico-chemical properties of the treated samples. The observed increase in plastic limit is typical of clays treated with binder reagents (Clare and Cruchley, 1957; Hilt and Davidson, 1960; Zolkov, 1962; Jan and Walker, 1963; Wang et al., 1963; Brandl, 1981; Rogers and Glendinning, 1996; Bell, 1996; Mesri et al., 1999). This has been attributed to formation of clay macro-aggregates, which entrap large volumes of water (Mesri et al., 1999). The changes in liquid limit are also consistent with literature results, which show either increase (Clare and Cruchley, 1957; Brandl, 1981; Bell, 1996) or decrease (Zolkov, 1962; Jan and Walker, 1963; Wang et al., 1963; Brandl, 1981; Bell, 1996) possibly as a result of changes in specific surface area of the clay upon binder treatment. In fact, while the addition of binders to clays results in destructuration of clay minerals, which gives rise to formation of high specific surface area calcium silicate and aluminate hydrates, it also results in the replacement of monovalent ions by Calcium and the formation of stable clay particle packets, or domains, through cation-linkage, and thus in a tendency to reduce specific surface area of clays (Diamond et al., 1964).

The small increases in concentrations of heavy aliphatics and aromatics observed in the soil and leachate samples, are probably the result of the release of these compounds, which are initially sorbed on the Soil Organic Matter (SOM), as the increase in pH associated with the binder mixing makes the SOM unstable (Bone et al., 2004).

A large increase in the UCS over the remolded value was achieved in all the treated samples but HL₂₀ and, to a certain extent, QL₂₀. The large increase in clay strength upon binder mixing is considered to be a result of an increase in interparticle contact area (Terzaghi et al, 1996), caused by the formation of clay macro-aggregates and domains, and interparticle bonding by the silicate hydrates gels produced by the pozzolanic reactions. The lower UCS values obtained in samples HL₂₀ and QL₂₀ might have been the result of premature failures along a weak zone of the samples during UCS test. The UCS results suggest that reagent mixing resulted in an increase of UCS over the estimated undisturbed value. This conclusion could have a significant practical implication on the in-situ remediation process, as the binder mixing effects would compensate and overcome any loss in strength due to the remolding effect of mechanical mixing and, therefore, result in strength larger than the original undisturbed strength of the clay.

The apparent favorable effects of gypsum, on the strength of soil treated with a predominantly lime based reagent formulation, is in agreement with findings of Pimraksa and Thongchai (2006), and may be explained as a result of formation of large agglomerates which act as bonding agents between clay particles / pozzolanic products system. In the case of cement treated soil, it seems possible that the large sulphate content (Table1), resulting from addition of gypsum to sample C₁₀G₁₀, caused formation of ettringite, which is known to cause expansion and development of cracks (Pimraksa and Thongchai, 2006). The propagation of these cracks might have created weakness zones resulting in smaller compression strength than in sample C₂₀ in which no gypsum was added.

5. CONCLUSIONS

The treatability study summarized in this paper confirmed that SRM with binders is a viable technique for remediation and improvement of geotechnical properties of the petroleum contaminated clayey soils, at a petrol filling station site in Kent, UK.

Mixing soils with lime and cement binder reagents resulted in significant decreases in total concentrations and leachability of petroleum hydrocarbon compounds and, therefore, reduced the risks of exposure for both human health and groundwater receptors, for a residential end-use redevelopment of the site. In addition, the treatment simultaneously improved the strength of the foundation soils for future development of the site. Addition of gypsum appears to improve the strength of the samples treated with a predominantly lime based reagent formulation, and to have less favorable effects on the strength of cement based formulations.

The decreases in petroleum hydrocarbons concentrations may be explained by a number of mechanisms, such as volatilization, encapsulation within the pozzolanic products matrix or the clay macro-aggregates voids, and possibly degradation of the hydrocarbon compounds promoted by the binder mixing. PID measurements indicated significant volatilization of light hydrocarbons during the mixing of the clay. The rate and magnitude of volatiles release during the soil mixing process is mainly related to the mechanical mixing action. Larger increases in temperature measured in the samples treated with quicklime, did not appear to result in higher reductions of hydrocarbons, than in samples treated with binder reagents with less pronounced exothermic reactions. Volatilization of light compounds during mixing is not of concern for the full scale SRM application since such emissions can be captured by appropriate vapor control devices (Brown et al., 1992).

ACKNOWLEDGEMENTS

The authors wish to thank Dr C.W. Evans, Mr. M. Webb, Ms. B. Harvey of Arcadis GMI and Ms Billie Jo Thibault of BBL-Arcadis for their contribution to the project.

REFERENCES

- Balasubramaniam, A.S., Bergado, D.T., Buensuceso, B.R. and Yang, Y.C. 1989. Strength and deformation characteristics of lime - treated soft clays. *Geotechnical Engineering*, 20, 49- 65.
- Bell, F.G. 1996. Lime stabilization of clay minerals and soils, *Engineering Geology*, 42, 49–65.
- Bone, B.D., Barnard, L.H., Boardman, D.I., Carey, P.J., Hills, C.D., Jones, H.M., MacLeod C.L. and Tyrer, M. 2004. Review of scientific literature on the use of stabilization/solidification for the treatment of contaminated soil, solid waste and sludges. Environment Agency Science Report SC980003 / SR2.
- Brandl, H. 1981. Alteration of soil parameters by stabilization with lime. 10th International Conference on Soil Mechanics and Foundation Engineering, Stockholm, 587 - 594.
- Brinkman, R. 1979. Clay transformations: aspects of equilibrium and kinetics, *Developments in Soil Science*, edited by G.H. Bolt, 433 -457.
- British Standards Institution (BSI) 1990. Methods of test for soils for civil engineering purposes. Classification tests, BS 1377: Part 2(3), 2-5. British Standards Institution, London.
- British Standards Institution (BSI) 1990. Methods of test for soils for civil engineering purposes. Classification tests, BS 1377: Part 2(4.3), 6-8. British Standards Institution, London.
- British Standards Institution (BSI) 1990. Methods of test for soils for civil engineering purposes. Classification tests, BS 1377: Part 2(5), 13-14. British Standards Institution, London.
- British Standards Institution (BSI) 1990. Methods of test for soils for civil engineering purposes. Part 4: Compaction-related tests, BS 1377: Part 4(3), 1-12. British Standards Institution, London.
- British Standards Institution (BSI) 1990. Methods of test for soils for civil engineering purposes. Part 7: Shear strength tests, BS 1377: Part 7(7), 19-22. British Standards Institution, London.
- Brown, R.E., Jindal, B.S. and Bulzan, J. 1992. A critical review of the effectiveness of stabilization and solidification of hazardous wastes. In: *Stabilization and solidification of hazardous radioactive and mixed waste*, edited by T.M. Gilliam and C.C. Wiles. ASTM STP Publication 1123.
- Butler, L.G., Owens, J.W., Cartledge, F.K., Kurtz, R.L., Byerly, G.R., Wales, A.J., Bryant, P.L., Emery, E.F., Dowd, B. and Xie, X. 2000. Synchrotron x-ray microtomography, electron probe microanalysis, and NMR of Toluene waste in cement. *Environmental Science and Technology*, 34, 3269 – 3275.
- Clare, K.E. and Cruchley, A.E. 1957. Laboratory experiments in the stabilization of clays with hydrated lime, *Géotechnique*, 17, 97 - 111.
- Conner, J. R. 1990. *Chemical Fixation and Solidification of Hazardous Wastes*. Van Nostrand Reinhold, New York.
- Croft, J.B. 1967. The Structures of soils stabilized with cementitious agents, *Engineering Geology*, 2, 63 - 80.
- Diamond, S., White, J.L. and Dolch, W.L. 1964. Transformations of clay minerals by calcium hydroxide attack, 12th National Conference on Clays and Clay Minerals, Atlanta, Ga, 359-379.
- Diamond, S. and Kinter, E.B. 1965. Mechanisms of soil-lime stabilization – an interpretative review, *Highway Research Record*, 92, 83 – 102.
- Eades, J.L. and Grim, R. 1960. Reactions of hydrated lime with pure clay minerals in soil stabilization, *Highway Research Board Bulletin*, 262, 51 - 63.
- Glenn, G.R. and Handy R.L. 1963. Lime-clay mineral reaction products, *Highway Research Record*, 29, 70 - 82.
- Goldberg, I. and Klein, A. 1952. Some effects of treating expansive clays with calcium hydroxide, ASTM Special Publication, No. 142.
- Graber, E.R., Fine, P. and Levy, G.J. 2006. Soil stabilization in semiarid and arid land agriculture. *Journal of Materials in Civil Engineering*, 18, 190- 205.
- Hansen, J.B, Grøn, C., Hjelmar, O., Asmussen, O., Klem, S., Mizutani, S., Gamst, J., Walström, M., Håkkanson, K. and Breedweld, G. 2004. Leaching tests for non-volatile organic compounds - development and testing. NT Techn Report 576 - Nordic Innovation Center Report 04211.
- Holm., G. 2005. Deep mixing - properties and applications. In: *Stabilization/Solidification Treatment and Remediation - Advances in S/S for Waste and Contaminated Land*, edited by A.Al-Tabbaa and J. Stegemann. Balkema Publishers, 2005, 7-10.
- Jan, M.A. and Walker, R.D. 1963. Effect of lime, moisture and compaction on a clay soil. *Highway Research Record* No 29, 1-12.
- Lewin, K., Bradshaw, K., Blakey, N.C., Turrel, J., Hennings, S.M. and Flavin, R.J. 1994. Leaching test for assessment of contaminated land. Interim NRA guidance. NRA R&D Note 301, Bristol, UK.
- Lindh, P. 2004. Compaction and strength properties of stabilized and unstabilised fine grained tills. Doctoral Thesis, Lund University. Report 66, Swedish Geotechnical Institute.
- Lopez-Lara, T., Zepeda-Garrido, J.A. and Castrario, V.M. 1999. A comparative study of the effectiveness of different additives on the expansion behavior of clays. *Electronic Journal of Geotechnical Engineering* (<http://www.ejge.com/1999/Ppr9904/Abs9904.htm>), Volume 4.
- Massachusetts Department of Environmental Protection. 2003. Method for the determination of the extractable petroleum hydrocarbons. Massachusetts Department of Environmental Protection, Office of Research and Standards, Bureau of Waste Site Cleanup.
- Mesri, G., Al-Zoubi, M., Schifano, V. and Shahien, M.M. 1999. Lime treatment soil testing, Fargo, North Dakota, section 14 project. Report DACW 37-99, US Army Corps of Engineers, St Paul District, Minnesota.

- Nestle, N., Zimmermann, C., Dakkouri, M. and Niessner, R. 2001. Action and distribution of organic solvent contaminations in hydrating cement : time-resolved insights into solidification of organic waste. *Environmental Science and Technology*, 35, 4953 – 4956.
- Pimraksa, K. and Thongchai, A. 2006. Strength enhancement effect of Mae Moh waste gypsum in lime-flyash soil stabilization. *International Conference on Pozzolan, Concrete and Geopolymer*, Khon Kaen, Thailand, May 24-25.
- Rogers, C.D.F. and Glendinning, S. 1996. Modification of clay soils using lime. In: *Lime Stabilization*, edited by C.D.F. Rogers, S. Glendinning and N. Dixon. Thomas Telford.
- Schifano, V., MacLeod, C.L., Hadlow, N. and Dudeney, R. 2006. Evaluation of quicklime mixing for the remediation of petroleum contaminated soils. *Journal of Hazardous Materials* (In Press).
- Schifano, V., MacLeod, C.L., Dudeney, A.W.L. and Dudeney, R. 2005. Remediation of soils contaminated with petroleum hydrocarbon using quicklime mixing. In: *Stabilization/Solidification Treatment and Remediation - Advances in S/S for Waste and Contaminated Land*, edited by A.Al-Tabbaa and J. Stegemann. Balkema Publishers, 69-78.
- Soundararajan, R. 1992. Guidelines for evaluation of the remanence of a stabilization / solidification technology. In: *Stabilization and solidification of hazardous radioactive and mixed waste*, edited by T.M. Gilliam and C.C. Wiles. ASTM STP Publication 1123.
- Terzaghi, K., Peck, R.B. and Mesri, G. 1996. *Soil mechanics in engineering practice*. John Wiley and Sons.
- United States Environmental Protection Agency (USEPA). 1996a. Method 8021b. Aromatic and halogenated volatiles using photoionisation and/or electrolytic conductivity detectors. EPA Report SW 846. Washington.
- United States Environmental Protection Agency (USEPA). 1996b. Method 8100. Polynuclear Aromatic Hydrocarbons. Washington.
- United States Environmental Protection Agency (USEPA). 1984. EPA Method study 25, Method 602, Purgeable aromatics. EPA Report 600/4-84-042. Washington.
- Wang, J.W.H., Mateos, M. and Davidson, D.T. 1963. Comparative effects of hydraulic, calcitic and dolomitic limes and cement in soil stabilization. *Highway Research Record* No 29, 42-54.
- Wiles, C.C. and Barth, E. 1992. Solidification / Stabilization: Is it always appropriate? In: *Stabilization and solidification of hazardous radioactive and mixed waste* edited by T.M. Gilliam and C.C. Wiles. ASTM STP Publication 1123.
- Wissa, A.E.Z., Ladd, C.C. and Lambe, T.W. 1965. Effective stress strength parameters of stabilised soils. *Proceedings of the VI international conference of soil mechanics and foundation engineering*, Montreal, 412-416.
- Zolkov, E. 1962. Influences of chlorides and hydroxides of calcium and sodium on consistency limits of a fat clay. *Highway Research Board Bulletin* 309, 109-115.

Chapter 27

BIODEGRADATION OF WEATHERED OIL IN SOILS WITH A LONG HISTORY OF TPH CONTAMINATION

Talaat Balba, Ph.D., Sophia Dore, Ph.D., Donald Pope, B.S., Jennifer Smith, M.S., Alan Weston, Ph.D.

Conestoga-Rovers & Associates, 2055 Niagara Falls Blvd, Niagara Falls, NY 14304, Tel: (716)-297-6150, Email: tbalba@croworld.com, sdore@croworld.com, dpope@croworld.com, jjsmith@croworld.com, aweston@croworld.com

Abstract: Sites with a long history of exposure to petroleum hydrocarbons contain mainly long chain hydrocarbons or “weathered oil”. This is because petroleum is a complex mixture of many organic compounds and these compounds biodegrade at different rates. Under aerobic conditions the shorter hydrocarbon chains biodegrade first and the longer chains are more recalcitrant.

Long chain hydrocarbons are less soluble in water and more like tar in consistency than the shorter chain hydrocarbons, so a major problem with the degradation of these compounds is that bacteria that break down hydrocarbons do not come into contact with them. These compounds are not bioavailable and therefore do not biodegrade.

A petroleum refinery that has been active for many years has a large amount of weathered oil in the surrounding soil and groundwater. A treatability study was performed on samples from the Site to determine whether conditions could be manipulated to stimulate the biodegradation of the weathered oils. Several sets of microcosms containing soil and groundwater were set up. Along with nutrients and an oxygen source, a biodegradable surfactant was added to some of the sets in order to determine whether increasing the bioavailability of the hydrocarbons would enhance their degradation.

After the microcosms were set up, there was an initial increase in hydrocarbons in the aqueous phase and a decrease in hydrocarbons in the soil phase in the microcosms that had received surfactant. This change was due to the surfactant solubilizing hydrocarbons out of the soil and into the water. As the experiment progressed however, a decline in hydrocarbon levels in both soil and groundwater was observed.

It was determined that by manipulating the conditions and solubilizing the hydrocarbons, biodegradation of weathered oils could be stimulated. Hydrocarbons could be removed from soils that had contained these weathered oils for many years without any appreciable degradation.

Key words: biodegradation; TPH; weathered oil; surfactant

1. INTRODUCTION

Several areas at an oil refinery site with a long history of operation have weathered oil floating on the surface of the groundwater and oil-saturated soil. CRA was requested to perform a treatability study to determine the feasibility of biodegradation for treatment of the oil-saturated soil.

Bioremediation is a treatment process whereby contaminants are metabolized into less toxic or nontoxic compounds by naturally occurring microorganisms. The microorganisms utilize the contaminants as a source of carbon and energy. The by-products are mainly carbon dioxide and

water. Once the microorganisms have consumed all of the contaminants, the microbial population becomes dormant or dies out.

Bioremediation can take place under aerobic or anaerobic conditions in the presence of other suitable electron acceptors such as nitrate, sulfate, or carbonate. Bioremediation can be applied in situ or ex situ to treat both soil and groundwater. It has been shown to be effective in treating a broad range of chemicals including petroleum hydrocarbons and chlorinated solvents.

Site conditions can be manipulated to enhance bioremediation and speed up the degradation rates of the contaminants. There are several techniques that can be applied to enhance the biological degradation of contaminants:

- i. supplementation with suitable sources of nitrogen and phosphorus;
- ii. manipulation of redox potential by the injection of air, oxygen, or nitrate to enhance aerobic biodegradation;
- iii. injection of co-substrates such as molasses, or lactate to enhance the biodegradation of chlorinated contaminants;
- iv. addition of surfactants to make the contaminants bioavailable; and
- v. site microbial inoculation.

Oxygen is often the limiting factor in aerobic bioremediation at many sites. The degradation of petroleum hydrocarbons occurs much faster under aerobic conditions compared to anaerobic conditions. Therefore, the addition of oxygen can significantly increase the remediation rates. Oxygen addition is most frequently used to address dissolved phase contamination, such as total petroleum hydrocarbons and BTEX, as well as contamination in the capillary fringe zone. Oxygen can only be effective if the hydrocarbons are bioavailable and there is no nutrient limitation.

Petroleum hydrocarbons are chemicals that occur naturally and have been used by humans as fuels and manufacturing chemicals. Because of this widespread use, environmental contamination by petroleum hydrocarbons is fairly common. Petroleum hydrocarbons are a broad class of compounds that include short chain compounds such as the components found in gasoline, medium chain compounds that comprise such products as fuel oil and heavy long chain compounds that are present in tar. Petroleum hydrocarbons are biodegradable under both aerobic and anaerobic conditions.

The objectives of the laboratory treatability study were to determine whether biodegradation of the oil in the soil is feasible and to identify amendments that would enhance biodegradation of the oil.

2. MATERIALS AND METHODS

A 5-gallon plastic bucket of soil was collected from the Site and homogenized in a cold room and then characterized for key parameters pertinent to biodegradation:

- Total hexane extractable hydrocarbons;
- pH;
- Ammonia nitrogen;
- Orthophosphate phosphorus;
- Total heterotrophic microbial counts; and
- C16 specific microbial counts.

Microcosm tests were then performed on the oil-saturated soil sample to assess the degradation rates of the weathered oil under optimized conditions. The testing included determination of the maximum percentage removal of oil from the soil by biodegradation and by solubilization of oil by Biosolve (a surfactant). The tests were conducted in serum bottles, each containing 20 g of soil and 100 mL of distilled water. The microcosm tests consisted of the following treatments:

- I. Soil and water only (biotic control);

- II. Soil, water and Biosolve;
- III. Soil, water, Biosolve, and nutrients;
- IV. Soil, water, Biosolve, nutrients and an oxygen source; and
- V. As in treatment (IV), with the addition of sodium azide (abiotic control).

Microcosms were sacrificed at T=0, 3 and 6 weeks and analyzed for hexane extractable hydrocarbons in the soil and water fraction.

3. RESULTS

The results of the initial analyses are shown in Table 1. Total petroleum hydrocarbons (TPH) in the soil were approximately 100,000 mg/kg. The pH of the soil was slightly above neutral and the microbial counts were fairly high. The high C16 specific counts indicated that a microbial population capable of degrading hydrocarbons is present at the Site. Nutrients, particularly ammonia-nitrogen, were low indicating that nutrient limitation may be impeding microbial growth.

Table 1. Initial Analysis of Soil Sample

| | Units | Initial Soil Sample |
|-------------------------------------|-------|---------------------|
| Total Petroleum Hydrocarbons | mg/kg | 116000/94100 |
| PH | S.U. | 7.8 |
| Total Aerobic Microbial Count | CFU/g | 2.5×10^6 |
| Total C16 Degrading Microbial Count | CFU/g | 5.7×10^6 |
| Ammonia-Nitrogen | mg/kg | 2.13 |
| Orthophosphate-Phosphorus | mg/kg | 18.1 |

The results of the analyses performed after 3 weeks are shown in Table 2 and after 6 weeks are shown in Table 3. Overall biodegradation of petroleum hydrocarbons (TPH) did not appear to occur in the soil microcosms within the six week period. The concentrations of TPH in the samples analyzed after six weeks were similar to those found in the T=0 samples.

The addition of biosolve, however, did result in the solubilization of TPH from the soil into the water. In the abiotic controls, after 3 weeks 6220 mg TPH per kg of soil had been solubilized from the soil into the water. After 6 weeks, the level was slightly lower, 4720 mg/kg. This decline may be due to oil re-adhering to the soil or to the sides of the serum bottle after initial solubilization.

Table 2. T=# Weeks Analysis of Microcosm Tests

| | Units | T=0 | Soil and | Soil, | Soil, Water, | Soil, water, | Nutrients, O ₂ and azide |
|---------------------------------|-------|-------------------|-------------------|-----------------------|---------------------------|--|--|
| | | | Water | Water and Biosolve | Biosolve and nutrients | biosolve, Nutrients and O ₂ | |
| | | Soil Fraction | Soil Fraction | Soil Fraction | Soil Fraction | Soil Fraction | Soil Fraction |
| Total Petroleum Hydrocarbons | mg/kg | 105000/ 101000 | 121000/ 90900 | 84200/ 90100 | 98300/ 87200 | 83300/ 109000 | 90800/ 10800 |
| | | Water Fraction | Water Fraction | Water Fraction | Water Fraction | Water Fraction | Water Fraction |
| Total Petroleum Hydrocarbons | mg/L | 249/263 | 70.4/64.3 | 519/638 | 186/302 | 438/311 | 1660/1340 |
| % TPH Removal from Soil | % | | <1 | 15.3 | 9.84 | 6.58 | 3.58 |
| % TPH Removal from Water | % | | 73.7 | <1 | 4.63 | <1 | <1 |
| Overall % TPH Removal | % | | <1 | 13.6 | 9.78 | 5.93 | <1 |
| TPH solubilized by Biosolve | mg/kg | | | | | | 6220 |

Table 3. T=6 Weeks Analysis of Microcosm Tests

| | Units | T=0 | Soil and Water | Soil, Water and Biosolve | Soil, Water, Biosolve and nutrients | Soil, water, biosolve, Nutrients and O2 | Soil, water, biosolve, Nutrients, O2 and azide |
|------------------------------|-------|-------------------|-------------------|--------------------------|-------------------------------------|---|--|
| | | Soil Fraction | Soil Fraction | Soil Fraction | Soil Fraction | Soil Fraction | Soil Fraction |
| Total Petroleum Hydrocarbons | mg/kg | 105000/ 101000 | 110000 /117000 | 103000/ 101000 | 105000/ 105000 | 124000/ 87300 | 103000/ 125000 |
| | | Water Fraction | Water Fraction | Water Fraction | Water Fraction | Water Fraction | Water Fraction |
| Total Petroleum Hydrocarbons | mg/L | 249/263 | 120/155 | 225/325 | 153/202 | 303/244 | 1100/1300 |
| % TPH Removal from Soil | % | | <1 | 0.67 | <1 | <1 | <1 |
| % TPH Removal from Water | % | | 46.2 | <1 | 30.7 | <1 | <1 |
| Overall % TPH Removal | % | | <1 | 0.57 | <1 | <1 | <1 |
| TPH solubilized by Biosolve | mg/kg | | | | | | 4720 |

4. DISCUSSION

Although microbial counts in the soil were quite high, microbial degradation of TPH was not observed during the 6 week period. It is likely that six weeks is not a long enough time for measurable removal of the hydrocarbons to occur, since the TPH in the soil consists of the longer chain hydrocarbons, which degrade slowly. The addition of nutrients and biosolve did not appear to speed up biodegradation.

Since biosolve did solubilize a significant amount of TPH from the soil, it is possible that it could be utilized to enhance recovery of TPH during groundwater extraction. The residual TPH in the soil could probably be removed by enhanced biodegradation, however the process would be slow.

Chapter 28

PERSULFATE DECOMPOSITION KINETICS IN THE PRESENCE OF AQUIFER MATERIALS

Kanwartej S. Sra¹, Jessica J. Whitney¹, Neil R. Thomson¹, and Jim F. Barker²

¹Department of Civil and Environmental Engineering, University of Waterloo, 200 University Ave. West, Waterloo, ON, Canada N2L 3G1; ²Department of Earth Sciences, University of Waterloo, 200 University Ave. West, Waterloo, ON, Canada N2L 3G1

Abstract: Persulfate is an emerging oxidant for *in situ* chemical oxidation (ISCO) applications with a high oxidation potential on activation ($E^{\circ} = 2.6$ V). The design of an oxidant remedial system involves a comprehensive understanding of a number of underlying physical and chemical processes. One of these processes, which impacts oxidant efficiency, involves the stability of the oxidant in the presence of natural aquifer materials. To improve our understanding and develop predictive relationships a series of batch experiments were designed to quantify the interaction between persulfate and aquifer materials. Well-characterized aquifer materials collected from seven sites across North America were used in this investigation. The batch experiments, run in triplicates for each aquifer material, were conducted to primarily observe and derive decomposition kinetic parameters for an experimental system that comprised of 100 g of solids, and 100 mL of solution with an initial persulfate concentration of 1000 mg/L. The decomposition of persulfate followed a first-order mass action law in the presence of all aquifer materials used in this study although the reaction rate coefficient varied by an order of magnitude (10^{-4} to 10^{-3} hr⁻¹). In general, the observed reaction rate coefficients were small indicating that persulfate will have a high stability in these aquifer systems. Preliminary test results suggest that persulfate decomposition is a function of the oxidant to solids mass ratio. Dissolved organic carbon, iron, and manganese concentrations decreased relative to background conditions; however, no correlation with the observed reaction rate coefficients was determined. Significant decreases in the chemical oxidant demand of solids exposed to persulfate indicate that oxidation of natural organic matter occurred in these batch systems.

Key words: persulfate, *in situ* chemical oxidation, decomposition kinetics, aquifer materials

1. INTRODUCTION

In situ chemical oxidation (ISCO) is a remediation technology which utilizes the oxidative potential of chemical compounds in order to treat contaminated subsurface media. A host of bench and pilot-scale experiments have been performed using permanganate and catalyzed hydrogen peroxide (e.g., Fenton's reagent), and hence a considerable amount of peer-reviewed literature is available that discusses their treatment efficiency, reaction kinetics with organic compounds, and interaction with naturally occurring reduced species (e.g., Schnarr et al., 1998; Yan and Schwartz, 2000; Siegrist et al., 2001; Mumford et al., 2005). Whereas permanganate is limited by its selective reactivity towards specific organic compounds and high natural oxidant demand (Brown et al., 2004; Xu and Thomson, 2004; Siegrist et al. 2001, Brown and Robinson, 2006), peroxide has a limited zone of influence because of its high decomposition rate and hence minimal persistence in the subsurface environment (Xu and Thomson, 2004). Persulfate is an emerging oxidant which has numerous

advantages; a high oxidation potential of 2.6 V through formation of sulfate free radicals, a high solubility in water, widespread reactivity with environmental contaminants, and high stability in aqueous systems (Huang et al., 2002; Liang et al., 2003; Huang et al., 2005; Watts and Teel, 2006). Although there have been numerous studies reporting the effectiveness of persulfate to treat contaminants ranging from chlorinated solvents to petroleum hydrocarbons to polycyclic aromatic hydrocarbons (e.g., Kronholm and Riekkola, 1999; Liang et al., 2004; Huang et al., 2005; Watts and Teel, 2006), peer-reviewed literature on the interaction between persulfate with aquifer materials and the stability of persulfate in groundwater is scarce. An understanding of this interaction is required for cost effective design (e.g., quantifying site specific oxidant dosing requirements and selecting oxidant delivery systems), and to establish persulfate as a viable oxidant for wide-spread use at the field scale.

It has been demonstrated that common oxidants (permanganate and hydrogen peroxide) used for *in situ* remediation are consumed or catalytically decomposed by non-target reductants in groundwater systems (Haselow et al., 2003; Xu and Thomson, 2004; Mumford et al., 2005). The reductive species in aquifer systems that may predominantly interact with *in situ* oxidants are organic matter and reduced minerals such as Fe (II), Mn (II) and S (-I,-II) (Appelo and Postma, 1996; Christensen et al., 2000). The reductive minerals maybe the largest oxidant sinks in some aquifer soils (Haselow et al., 2003) while in others natural organic matter (NOM) maybe the major oxidant consumer (Siegrist et al., 1999). Since each oxidant behaves in a different manner in the presence of reductive species in aquifer systems (Brown, 2004), it has yet to be demonstrated that it is possible to derive predictive relationships using the total reductive capacity (TRC) with either the amount of oxidant mass consumed (for permanganate) or the enhanced decomposition rate (for hydrogen peroxide). It is evident that degradation and consumption kinetics of oxidants in aquifer systems are more accurately estimated by experimental studies than by empirical correlations.

The realm of research dealing with persulfate degradation in the presence of naturally occurring aquifer species has been narrow and contradictory. Brown (2004) investigated the relative soil oxidant demand (SOD) of permanganate and persulfate and concluded that while permanganate mass consumption was almost entirely due to natural organic matter (NOM) in soil, persulfate loss to decomposition was primarily due to the interaction with reductive minerals and the SOD of persulfate was much less than that of permanganate. These observations were based on SOD experiments conducted on a single soil type and it was hypothesized that reactions between permanganate or persulfate and NOM were fundamentally different. These results contradicted the earlier study by Hoag et al. (2000) which, based on the premise that NOM was equally oxidizable by persulfate or permanganate, suggested the use of persulfate to reduce the SOD prior to the addition of permanganate. Dahmani et al. (2006) also concluded that persulfate was capable of satisfying the SOD before injection of permanganate while providing an additional bonus of treating target contaminants. The abundance of Fe and Mn in the field study by Dahmani et al. (2006) was interpreted as a high persulfate demand whereas a lower NOM content was assumed to produce lesser oxidant demand. In studies dealing with organic rich soils which are physically and chemically different from aquifer materials, persulfate only partially consumed the soil organic matter (Cuypers et al., 2000). Kiem and Kogel-Knabner (2002) observed a 93% decrease in organic carbon when persulfate was applied to loamy and sandy surface soils for 16 hours while Eusterhues et al. (2003) found that a contact time of 2 days was insufficient to oxidize organic matter in some soils; this non-oxidizable fraction could comprise ~80% of total soil carbon in subsurface horizons. The debatable and empirical nature of conclusions drawn from these studies and the emergence of persulfate as a viable *in situ* oxidant was the impetus for this independent evaluation of the interaction between persulfate and aquifer materials.

The present study focuses on investigating the interactions of persulfate with various well characterized aquifer materials collected from seven sites across North America. These sites are hydrogeologically favorable to ISCO treatment and the interaction of these aquifer materials with permanganate and hydrogen peroxide has been investigated extensively at the bench-scale as part of another on-going study (Xu and Thomson, 2006 a,b). Apart from quantifying persulfate degradation kinetics, this present study seeks to determine the changes caused in aquifer and solution

characteristics due to oxidation, and attempts to develop predictive relationships between the quantifiable aquifer properties and persulfate decomposition rate coefficients.

2. MATERIAL AND METHODS

A series of bench-scale experiments comprising of completely mixed batch reactor systems were undertaken to investigate the degradation of persulfate in the presence of aquifer materials. Initially each reactor (300 mL) was filled with 100 g of aquifer solids and 100 mL of Milli-Q water and thoroughly mixed and allowed to equilibrate for 24 hours. Following this 24-hour equilibration period, a 10 mL aliquot of solution was taken and analyzed to establish background or pre-oxidation aqueous conditions (i.e., dissolved total iron, total manganese, and organic carbon). To restore the aqueous volume to 100 mL, an additional 10 mL of Milli-Q water was added to each reactor. The contents were then spiked with 0.1 g persulfate and vigorously mixed to generate an initial oxidant concentration of ~1000 mg/L. Each reactor was manually shaken daily to maximize contact between interacting constituents. At regular time intervals, an aliquot (2 to 3 mL) was collected from the supernatant portion of each reactor and transferred into 10 mL vials where aquifer solids, if any, were allowed to settle for an hour. Quantification of persulfate was then performed in duplicate and required only a total of 0.2 mL of the 2 to 3 mL aliquot; the remaining aqueous volume of the vial was returned to each reactor to minimize loss of persulfate mass due to sampling. Triplicate reactors were used for each aquifer material. Table 1 provides a general description of each aquifer material along with relevant physico-chemical properties. To avoid the complexity arising from using large grain sizes, materials that passed through No. 10 U.S. standard mesh sieve (<2 mm) were air dried to constant weight at 105°C and used in all experiments. To evaluate the effects of a different oxidant to solids mass ratio, an additional set of reactors using 150 g of the LSU aquifer material instead of 100 g was also employed in this investigation.

After ~80 days of exposure to persulfate, samples from the supernatant were taken and analyzed for total dissolved iron, manganese and organic carbon. Contents of each reactor were then thoroughly flushed with Milli-Q water to remove any persulfate and air dried. Triplicate sub-samples of this air-dried aquifer material were analyzed for a post-oxidation estimate of the chemical oxidant demand (COD) following the procedure given by Xu and Thomson (2006a).

Table 1. Aquifer material nomenclature and selected physico-chemical properties

| Site ID | Location | Description | TOC (mg/g) | Total Fe (mg/g) | Total Mn (mg/g) |
|---------|--|-------------------------------------|---------------|--------------------|--------------------|
| Borden | CFB Borden, ON, Canada | fine/medium sand | 0.24 | 17.5 | 0.421 |
| DNTS | National Test Site, Dover AFB, DE | fine to medium silty sand | 0.28 | 63.8 | 0.154 |
| LAAP | Longhorn Army Ammunition Plant, TX | fine silty sand | 0.46 | 22.7 | 0.112 |
| LSU | Launch Complex 34, Cape Canaveral AFS, FL | sand & silty sand | 1.84 | 6.1 | 0.068 |
| USU | Launch Complex 34, Cape Canaveral AFS, FL | sand & silty sand | 0.878 | 3.7 | 0.098 |
| MAAP | Milan Army Ammunition Plant, TN | sand & silty sand | 0.77 | 0.9 | 0.025 |
| NIROP | Bacchus Works Facility, Utah | sandy/silty gravels, sand layers | 0.315 | 12.9 | 0.297 |

Quantification of sodium persulfate concentration was performed following the procedure described by Huang et al. (2002) with a slight variation to account for the interferences arising from aqueous sample coloration due to the presence of aquifer solids. Samples were filtered using 0.45 micron filter (Pall Corp.) as required. Sodium persulfate (Aldrich Chem. Co., Milwaukee), ferrous ammonium sulfate (EMD Chemicals, Gibbstown), sodium thiocyanate (J.T.Baker, Phillipsbourg) and sulfuric acid solutions were prepared to required concentrations using Milli-Q water. All chemicals were ACS grade unless stated otherwise. DOC was quantified using a Total Organic Carbon analyzer (Shimadzu, Model-5050A), and iron and manganese concentrations were determined using

inductively coupled plasma (ICP) emission spectroscopy (Spectro Analytical, Fitchburg, MA). Measurement of pH was performed using an Orion pH meter (Model 290A).

3. RESULTS AND DISCUSSION

Normalized persulfate concentration temporal profiles over the ~80 day reaction period for each aquifer material are shown in Fig. 1. Each data point represents the average from triplicate reactors. For the LSU aquifer material the notation LSU-100 and LSU-150 indicate results from reactors using 100 and 150 g of aquifer solids respectively. The control reactor which contained only persulfate at a concentration of 1000 mg/L showed no indication of persulfate degradation. For all aquifer materials, the decomposition of persulfate followed first-order reaction kinetics, and a summary of the observed reaction rate coefficients and associated half-lives are listed in Table 2. Reaction rate coefficients varied by an order of magnitude from 10^{-4} to 10^{-3} hr^{-1} for the 7 aquifer materials used in this investigation. In general, the half-life data (inversely proportional to the reaction rate coefficient) suggests that persulfate will be highly stable in aquifer systems and hence from a remediation perspective is a suitable ISCO oxidant. The results from the tests performed using the LSU aquifer material (with 100 and 150 g of solids) show that the observed reaction rate coefficient is higher for LSU-150 than for LSU-100. Additional results, not shown here, confirm that the observed reaction rate coefficient is inversely related to the oxidant to aquifer solids mass ratio, and that the observed reaction rate coefficient is scalable thereby making it possible to extrapolate results from batch experiments to *in situ* conditions.

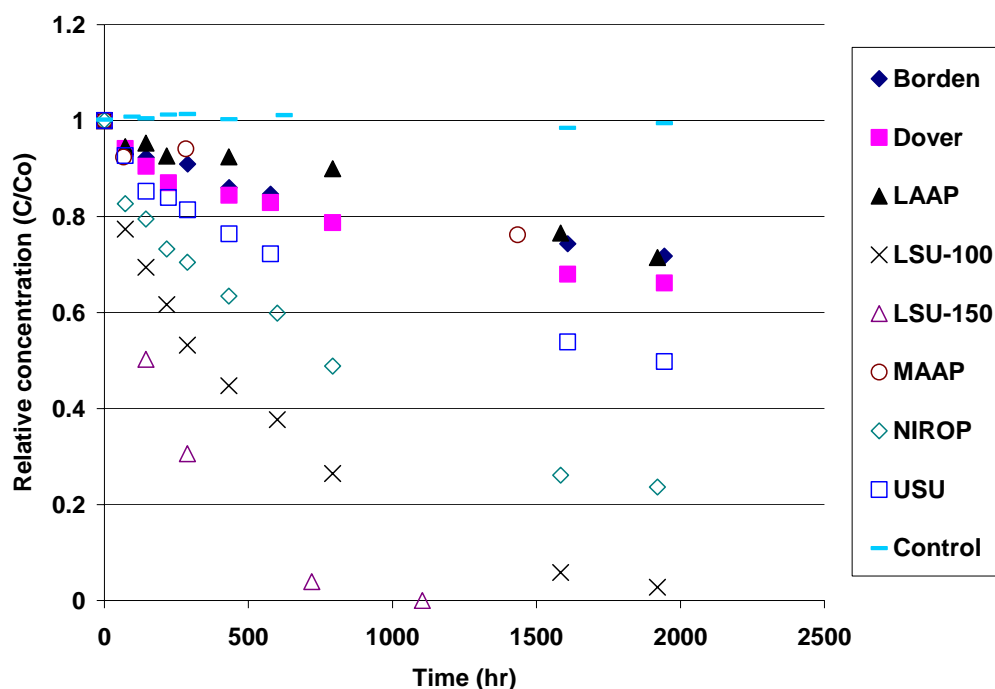

Figure 1. Temporal persulfate concentration profiles in the presence of the 7 aquifer materials used in this study. Also shown is the average concentration profile from the control reactor.

It is obvious from the observed persulfate decomposition trends that batch tests conducted over a ten-day period are insufficient to accurately observe persulfate stability for remedial system design as suggested by Dahmani et al. (2006). The series of batch experiments we performed were conducted under well-mixed conditions in order to maximize contact and hence the production of free radicals may over-estimate *in situ* reaction rate coefficients.

Table 2. First-order reaction rate coefficients and half-lives derived from batch test data.

| Soil | Rate of reaction, k_{obs} (10^{-4} hr^{-1}) | Half-life (hr) | R^2 |
|---------|---|-------------------|-------|
| Borden | 1.66 | 4174.7 | 0.933 |
| Dover | 2.47 | 2805.7 | 0.848 |
| LAAP | 1.56 | 4442.3 | 0.965 |
| LSU-100 | 18.19 | 381.0 | 0.993 |
| LSU-150 | 44.51 | 155.7 | 0.997 |
| MAAP | 1.54 | 4500.0 | 0.952 |
| NIROP | 7.97 | 869.5 | 0.969 |
| USU | 3.69 | 1878.0 | 0.935 |

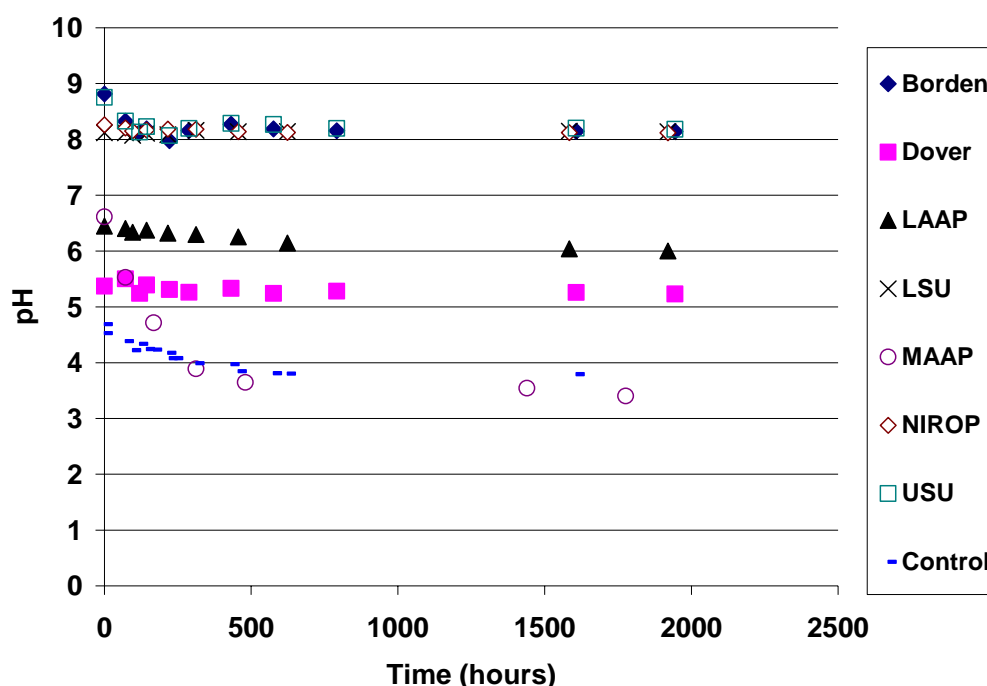

Figure 2. The temporal pH profile as observed in the various batch reactor systems.

Solution pH was monitored over time (Fig. 2) and the results showed only a slight decrease after the second sampling point to the end of the 80-day reaction period for all aquifer materials except MAAP. The decreasing pH profile probably indicates a marginally dynamic system perhaps due to an acid generating reaction or a slow buffering response relative to the initial pH condition.

The results from the dichromate COD analyses performed on all aquifer materials pre- and post-oxidant exposure showed a 2 to 40 % change in the COD values (Fig. 3). This change was statistically significant (t -test, $\alpha = 0.05$) for all aquifer materials except for LAAP, USU, and the 150 g LSU batch system. The solids used in the 100 g LSU batch system showed a much greater change in COD than the solids used in the 150 g LSU batch system presumably due to a higher oxidant to solid mass ratio and a longer persulfate exposure time in the 100 g LSU system. These results are again indicative of the fact that persulfate may not be able to significantly satiate the soil oxidant demand prior to addition of other oxidants like permanganate (Hoag et al., 2000; Brown, 2004). Xu and Thomson (2006a) concluded that for the aquifer materials used in this investigation the major contributor to the initial COD capacity was the TOC content, and hence a reduction in COD due to exposure to persulfate implies that significant oxidation of NOM occurred in these batch systems. Reduction in DOC concentration discussed later is also indicative of this oxidation reaction.

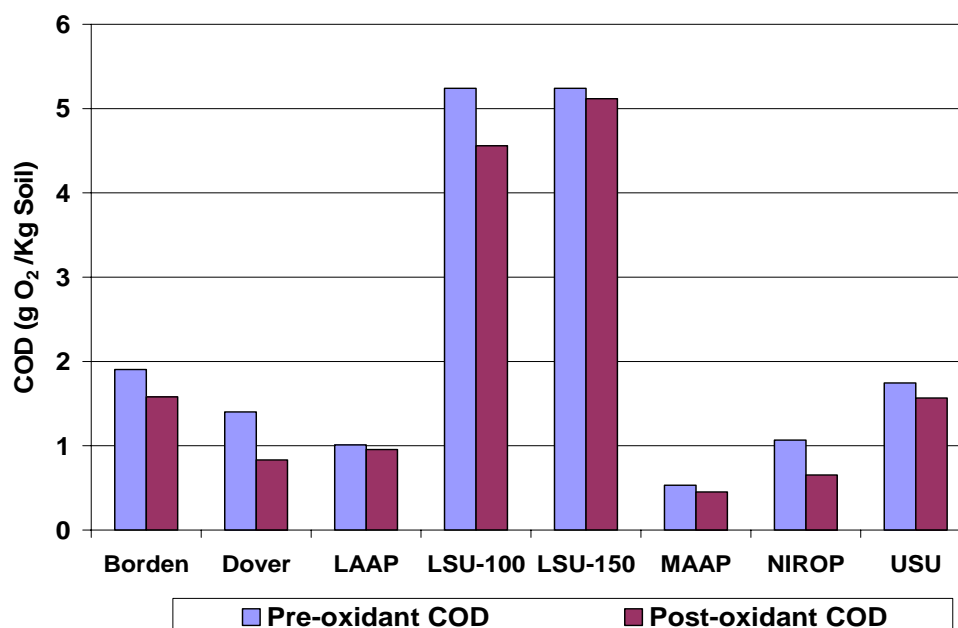

Figure 3. Pre- and post-oxidant dichromate COD test results.

Pre- and post-oxidant analysis of total dissolved iron, total dissolved manganese, and DOC yielded interesting results (Fig. 4). By the end of the reaction period, both iron and manganese concentrations dropped to very low values, while the DOC was reduced by 10 to 60%. It is speculated that both iron and manganese were involved in the catalytic activation of persulfate to produce the sulfate free radical which apart from the persulfate auto-decomposition reactions may have resulted in DOC oxidation to CO₂. However, probably due to slow nature of the reactions no gas production was visually observed in any of the batch reactors.

A correlation analysis between the observed reaction rate coefficients and various physico-chemical aquifer properties that may be responsible for the degradation reaction was performed; however, no significant ($r > 0.7$) correlation was apparent. In addition, no significant correlation was observed between dissolved iron, manganese or organic carbon concentrations and the observed reaction rate coefficients.

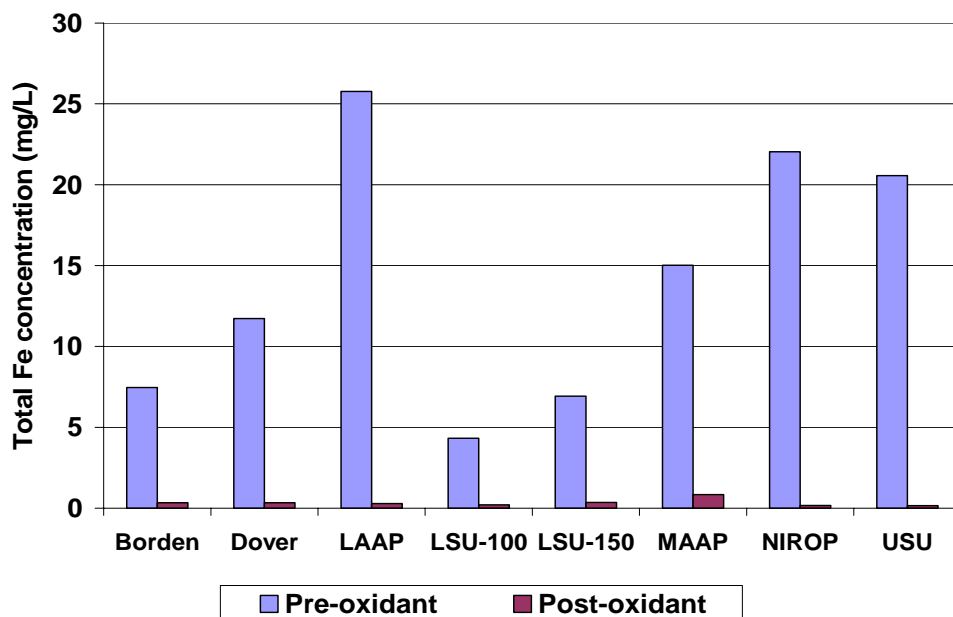

Figure 4a. Pre- and post-oxidant dissolved iron concentration.

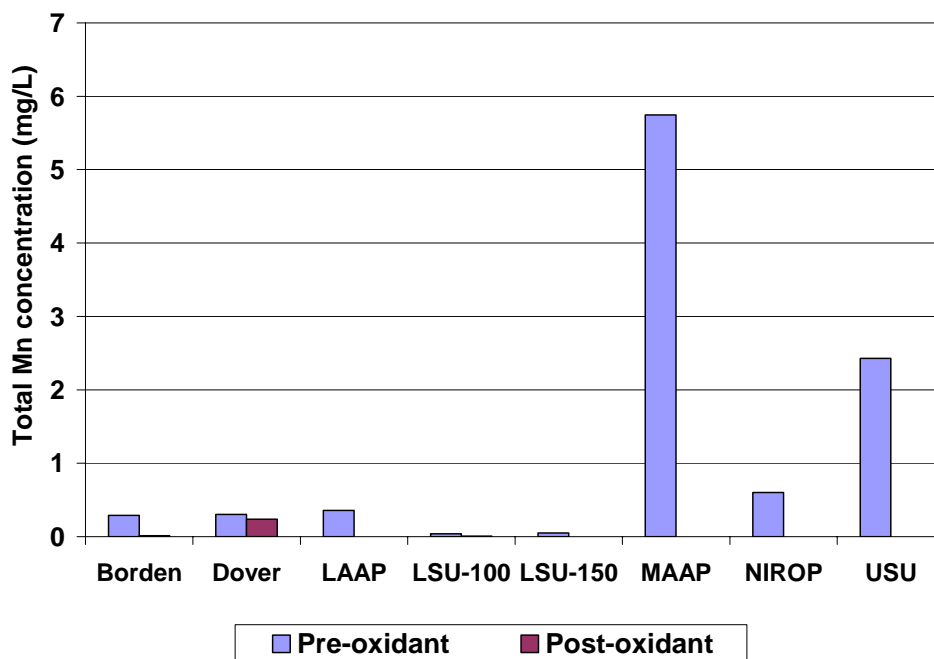

Figure 4b. Pre- and post-oxidant total dissolved manganese concentration.

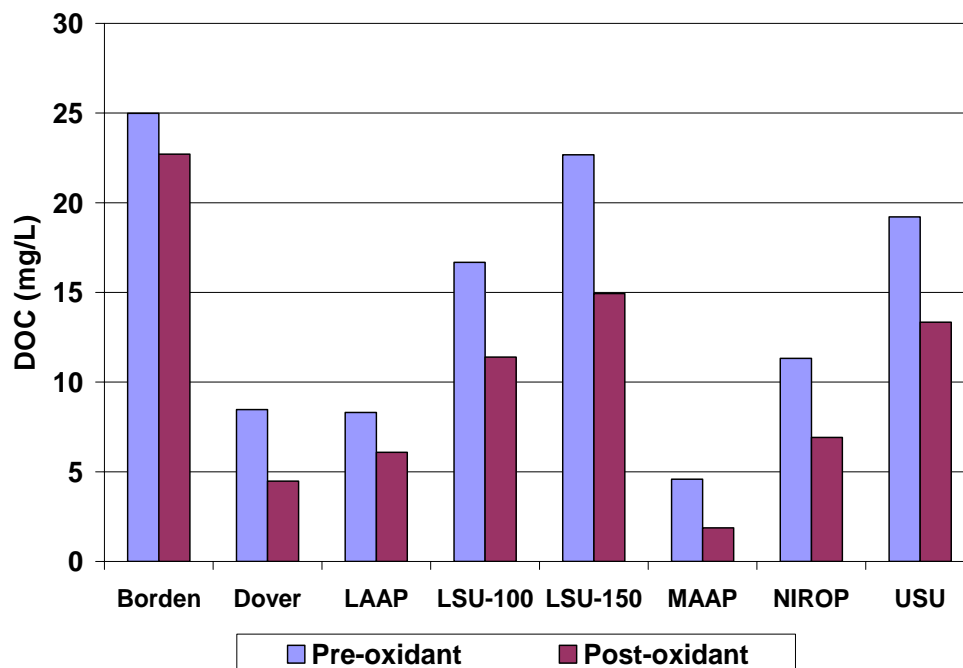

Figure 4c. Pre- and post-oxidant dissolved organic carbon (DOC) concentration.

4. SUMMARY

The decomposition of persulfate followed a first-order mass action law in the presence of all aquifer materials used in this study although the reaction rate coefficient varied by an order of magnitude (10^{-4} to 10^{-3} hr^{-1}). The observed reaction rate coefficients were small indicating that persulfate will have a high stability in these aquifer systems. Dissolved organic carbon, iron, and manganese concentrations decreased relative to background conditions; however, no correlation with the observed reaction rate coefficients was determined. Iron and manganese maybe involved in catalytic activation of persulfate. Significant decreases in the chemical oxidant demand of solids exposed to persulfate of 80 days indicate that oxidation of natural organic matter occurred in 4 of the 7 batch systems. The preliminary results presented and briefly discussed here are part of a larger ongoing investigation addressing the *in situ* fate and transport of persulfate.

REFERENCES

- Appelo, C.A.J., and Postma, D., 1996. Geochemistry, groundwater and pollution. A.A. Balkema/Rotterdam/Brookfield.
- Brown, R.A., and Robinson, D., 2004. Response to naturally occurring organic material: permanganate versus persulfate, In: Proceedings of the Fourth International Conference of Remediation of Chlorinated and Recalcitrant Compounds (Monterey, CA, May 24-27, 2004), (Gavaskar, A.R., and Chen, A.S.C., Eds.), Battelle Press, Columbus, Ohio.
- Christensen, T.H., P.L. Bjerg, S.A. Banwart, R. Jakobsen, G. Hertton, H.J. Albrechtsen, 2000. Characterization of redox conditions in groundwater contaminant plumes. *J. Contam. Hydrol.*, 45, 165-241.
- Cuypers, C., Grotenhuis, T., Joziase, J., and Rulkens, W., 2000. Rapid persulfate oxidation predicts PAH bioavailability in soils and sediments, *Environ. Sci. Technol.*, 34, 2057-2063.
- Dahmani, M.A., Huang, K., and Hoag, G.E., 2006. Sodium persulfate oxidation for the remediation of chlorinated solvents (USEPA superfund innovative technology evaluation program), *Water, Air and Soil Pollution: Focus*, 6, 127-141.
- Eusterhues, K., Rumpel, C., Kleber, M., and Kogel-Knabner, I., 2003. Stabilization of soil organic matter by interactions with minerals as revealed by mineral dissolution and oxidative degradation, *Org. Geochem.*, 34, 1591-1600.
- Gates-Anderson, D.D., Siegrist R.L., and Cline, S.R., 2001. Comparison of potassium permanganate and hydrogen peroxide as chemical oxidants for organically contaminated soils. *J. Environ. Eng.*, 127(4), 337-347.

- Haselow, J.S., R.L. Siegrist, M. Crimi, T. Jarosch, 2003. Estimating total oxidant demand for in situ chemical oxidation design. *Remediation Journal*, 13(4), 5-16.
- Hoag, G.E., Chheda, P.V., Woody, B.A., and Dobbs, G.M., 2000. Chemical oxidation of volatile organic compounds. United States Patent Number: 6019548.
- Huang, K.C., Hoag, G.E., Chheda, P., Woody, B.A., and Dobbs, G.M., 2001. Kinetics study of oxidation of chlorinated ethenes with permanganate. *J. Hazard. Mater.*, 87, 155-169.
- Huang, K., Couttenye, R.A., and Hoag, G.E., 2002. Kinetics of heat-assisted persulfate oxidation of methyl tert-butyl ether (MTBE), *Chemosphere*, 49, 413-420.
- Huang, K., Zhao, Z., Hoag, G.E., Dahmani, A., and Block, P.A., 2005. Degradation of volatile organic compounds with thermally activated persulfate oxidation, *Chemosphere*, 61, 551-560.
- Kiem, R., and Kogel-Knabner, I., 2002. Refractory organic carbon in particle-size fractions of arable soils II: organic carbon in relation to mineral surface area and iron oxides in fractions <math><6\mu\text{m}</math>, *Org. Geochem.*, 32, 733-744.
- Kronholm, J., and Riekkola, M., 1999. Potassium persulfate as oxidant in pressurized hot water, *Environ. Sci. Technol.*, 33, 2095-2099.
- Kronholm, J., Jyske, P., and Riekkola, M., 2000. Oxidation efficiencies of potassium persulfate and hydrogen peroxide in pressurized hot water with and without preheating, *Ind. Eng. Chem. Res.*, 39, 2207-2213.
- Liang, C., Bruell, C.J., Marley, M.C., and Sperry, K.L., 2004. Persulfate oxidation for in situ remediation of TCE. I and II, *Chemosphere*, 55, 1225-1233.
- Liang, C.J., Bruell, C.J., Marley, M.C., and Sperry, K.L., 2003. Thermally activated persulfate oxidation of trichloroethylene (TCE) and 1,1,1-trichloroethane (TCA) in aqueous systems and soil slurries, *Soil Sediment Contam.*, 12,(2), 207-228.
- Mumford, K.G., Thomson, N.R., Allen-King, R.M., 2005. Bench-scale investigation of permanganate natural oxidant demand kinetics, *Environ. Sci. Technol.*, 39(8), 2835-2849.
- Schnarr, M., Truax, C., Farquhar, G., Hood, E., Gonullu, T., Stickney, B., 1998. Laboratory and controlled field experiments using potassium permanganate to remediate trichloroethylene and perchloroethylene DNAPLs in porous media. *J. Contam. Hydrol.*, 29, 205-224.
- Siegrist, R.L., Urynowicz, M.A., West, O.R., Crimi, M.L., Lowe, K.S., 2001 (Eds.). *Principles and Practices of In Situ Chemical Oxidation Using Permanganate*. Battelle Press, Columbus, Ohio.
- Watts, R.J., and Amy L. Teel, 2006. Treatment of contaminated soils and groundwater using ISCO. *Practice Periodical of Hazardous, Toxic, and Radioactive Waste Management*, 10(1), 2-9.
- Xu, X., and Thomson, N.R., 2004. Oxidant fate and mobility, Controlling factors and estimation methods, In: *Proceedings of the Fourth International Conference of Remediation of Chlorinated and Recalcitrant Compounds* (Monterey, CA, May 24-27, 2004), (Gavaskar, A.R., and Chen, A.S.C., Eds.), Battelle Press, Columbus, Ohio.
- Xu, X., and Thomson, N.R., 2006a. Estimation of the maximum consumption of permanganate by aquifer solids using a modified chemical oxygen demand test, Submitted to *ASCE J. Environ. Eng.*
- Xu, X., and Thomson, N.R., 2006b. A multi-site permanganate NOD bench-scale investigation, in preparation.
- Yan, Y.E., and Schwartz, F.W., 2000. Kinetics and mechanisms for TCE oxidation by permanganate. *Environ. Sci. Technol.* 34, 2535-2541.

Chapter 29

AN INNOVATIVE APPROACH TO PROTECTING A MUNICIPAL SUPPLY WELL – AIR/OZONE SPARGE CURTAIN RESULTS

Vern Elarth, PG¹, Scott Rice, PG¹, Ed Tarter, PE¹, Kent Zenobia, PE, DEE¹, and Nicole Damin²

¹URS Corporation; ²Stanislaus County Department of Environmental Resources

Abstract: Petroleum contamination from a gasoline station threatened a nearby municipal supply well. MTBE was present in groundwater up to 30,000 µg/L in the first encountered groundwater aquifer—30 to 45 feet bgs. The muni well is 200 feet downgradient of the source area, and monitoring indicated MTBE had migrated off site towards the well, necessitating remedial action. An innovative remediation system was designed, combining aggressive source area treatment using soil vapor extraction and a downgradient in situ treatment barrier at the property boundary.

The downgradient in situ treatment barrier includes air/ozone sparge wells placed between the source area and the muni well to reduce/destroy MTBE and other residual gasoline-range organic contamination. The barrier—a sparge curtain—comprises dual-completion air/ozone sparge points co-located in the aquifer's deeper and shallow portions.

Pilot test results showed MTBE concentrations were 780 µg/L initially, 50 µg/L after 8 days, and 1.5 µg/L after 35 days, and tertiary compounds were not generated. A downhole video camera recorded the intercept on the monitoring well from the sparge points. Contaminant concentrations in downgradient wells have shown further improvement, and the system continues to protect the well. Site closure is expected following further monitoring.

Key words: Muni well protection, air/ozone sparging, downhole video camera, remediation, innovative remedial process, MTBE

1. INTRODUCTION

Releases of petroleum contaminants from a retail gasoline station in a medium-sized California Central Valley town threatened a municipal supply well (muni well) immediately adjacent to the station. Methyl *tert*-butyl ether (MTBE) was present in groundwater concentrations up to 30,000 micrograms per liter (µg/L) in the first encountered groundwater aquifer, between 30 to 45 feet below ground surface (bgs). The muni well is open-bottomed at 260 feet bgs and completed to a depth of 290 feet bgs, and is located approximately 200 feet downgradient from the source area. The project team's concern was the potential for MTBE to be pulled toward the muni well's screened interval in the deeper zone, thereby compounding the complexity of site restoration. Subsequent quarterly groundwater monitoring results indicated that MTBE had been migrating off site and that remedial action was required to protect the downgradient well.

In response, the project team designed an innovative remediation system for this site, comprising aggressive source area treatment with soil vapor extraction (SVE) for vadose zone contamination and a downgradient *in situ* treatment barrier at the property boundary. The comprehensive remediation process combines an *in situ* air/ozone sparging system with the SVE system. The *in situ* treatment barrier includes air/ozone sparge wells placed downgradient of the source area and upgradient of the muni well. The system is designed to reduce/destroy the concentrations of MTBE and other residual

gasoline-range organic (GRO) compounds. The perimeter *in situ* treatment barrier is referred to as a sparge curtain, comprising a line of air/ozone sparge points with overlapping radii of influence (ROIs) co-located in the deeper and shallow portions of the first encountered aquifer. During preparation of the Corrective Action Plan (CAP) and the permitting process, the local County Lead Enforcement Agency (LEA) expressed their concern over generating potentially harmful tertiary compounds as the result of the potential oxidation reactions of ozone and aquifer materials. URS developed a pilot test protocol for this process and agreed to share test results with the LEA prior to exercising full system operation. These results showed an initial "Time 0" MTBE concentration of 780 µg/L in the monitoring well. The concentration dropped to 50 µg/L after 8 days and to 1.5 µg/L after 35 days. In addition, test results showed that tertiary compounds were not generated. To further alleviate LEA's concerns with this innovative remedial process operation, the pilot test protocol included deployment of a down-hole video camera, in combination with dissolved oxygen meter results, to record the intercept on the monitoring well from the local sparge point locations. Contaminant concentrations in downgradient wells have shown further improvement, and the system continues to protect the muni well.

The subject site, a retail gasoline station in California's Central Valley, originally received a "no further action" resolution in 1996, but GRO and MTBE compounds were confirmed present in groundwater samples taken during Phases I and II investigations conducted in 2003, after new underground storage tanks (USTs) were installed. Results showed both soil and groundwater contamination. In December 2004, groundwater data revealed a relatively large groundwater plume of GRO compounds, including MTBE. Concentrations have ranged as high as 33,000 µg/L of GRO (by Method SW8015 [Mod.]) and 30,000 µg/L of MTBE (by Method SW8260B) in samples collected from monitoring well MW-11. These analytes were acknowledged to be a threat to groundwater drinking water supplies, because the plume was migrating off site toward a city municipal water supply well. The muni well is located approximately 120 feet to the southeast of the gas station property, and protection of this well was of paramount importance. To achieve muni well protection and control off-site migration of the plume, various remedial technologies were evaluated. An air/ozone sparge curtain was selected to contain the plume and reduce the threat.

2. BACKGROUND

The site is located at a busy intersection in a California Central Valley town (Figure 1). The northern portion of the site is an operating gasoline station and mini-mart. Property facilities include three gasoline USTs and associated product lines and dispensers. To the south is a car rental agency. Both properties are relatively flat, mostly paved, and have a surface elevation of approximately 90 feet above mean sea level. An operating muni well is located approximately 120 feet to the southeast of the gasoline station property, near the southeast corner of the car rental agency property.

Investigation of this site was initiated in 1990 when a leak was discovered in the product line located between the north pump island and the building. Since then, many well installation efforts have taken place to define the plume's extent. Figure 2 is a site map locating all of the installed monitoring wells and vapor extraction wells, and the air/ozone sparge locations.

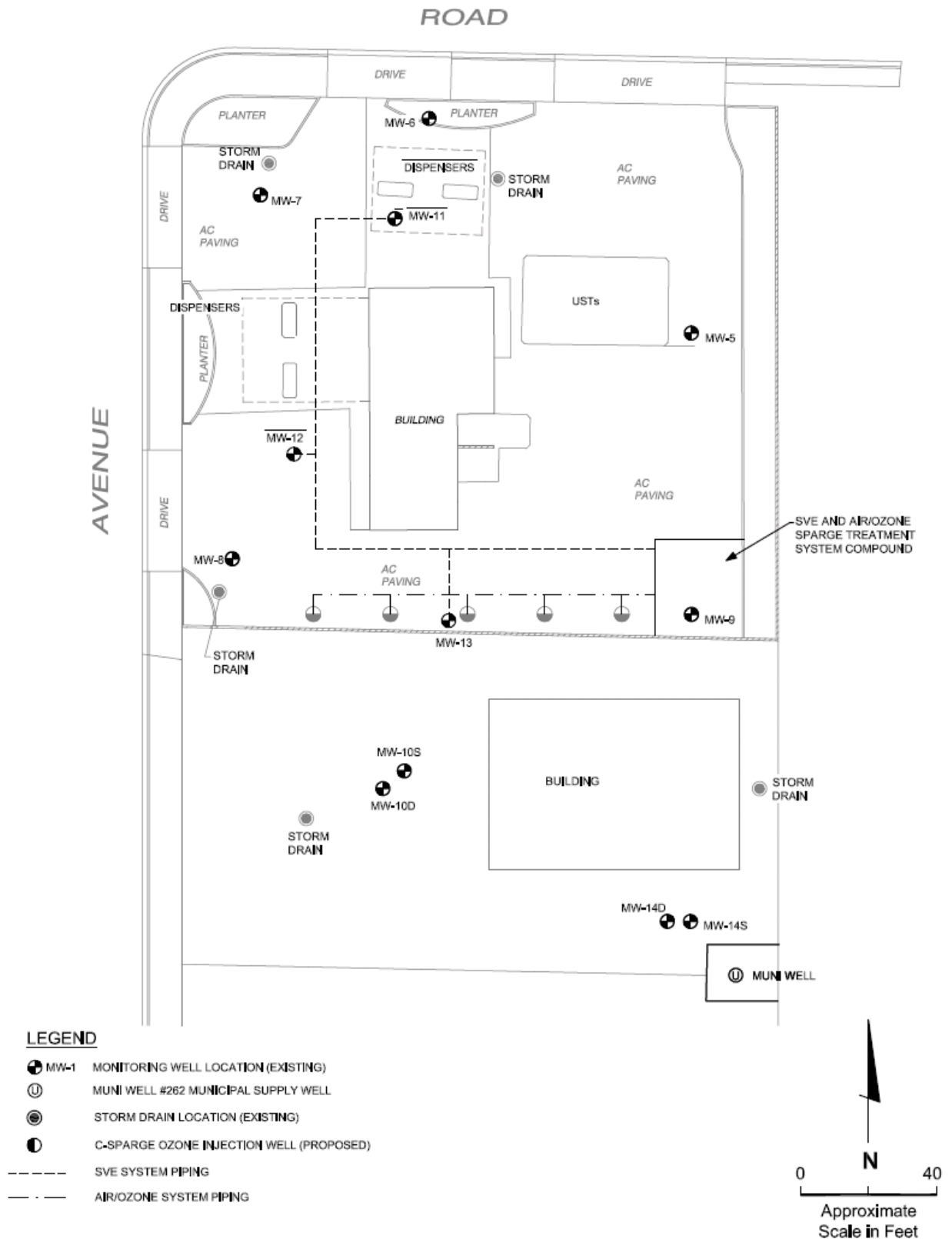

Figure 1. Site Plan

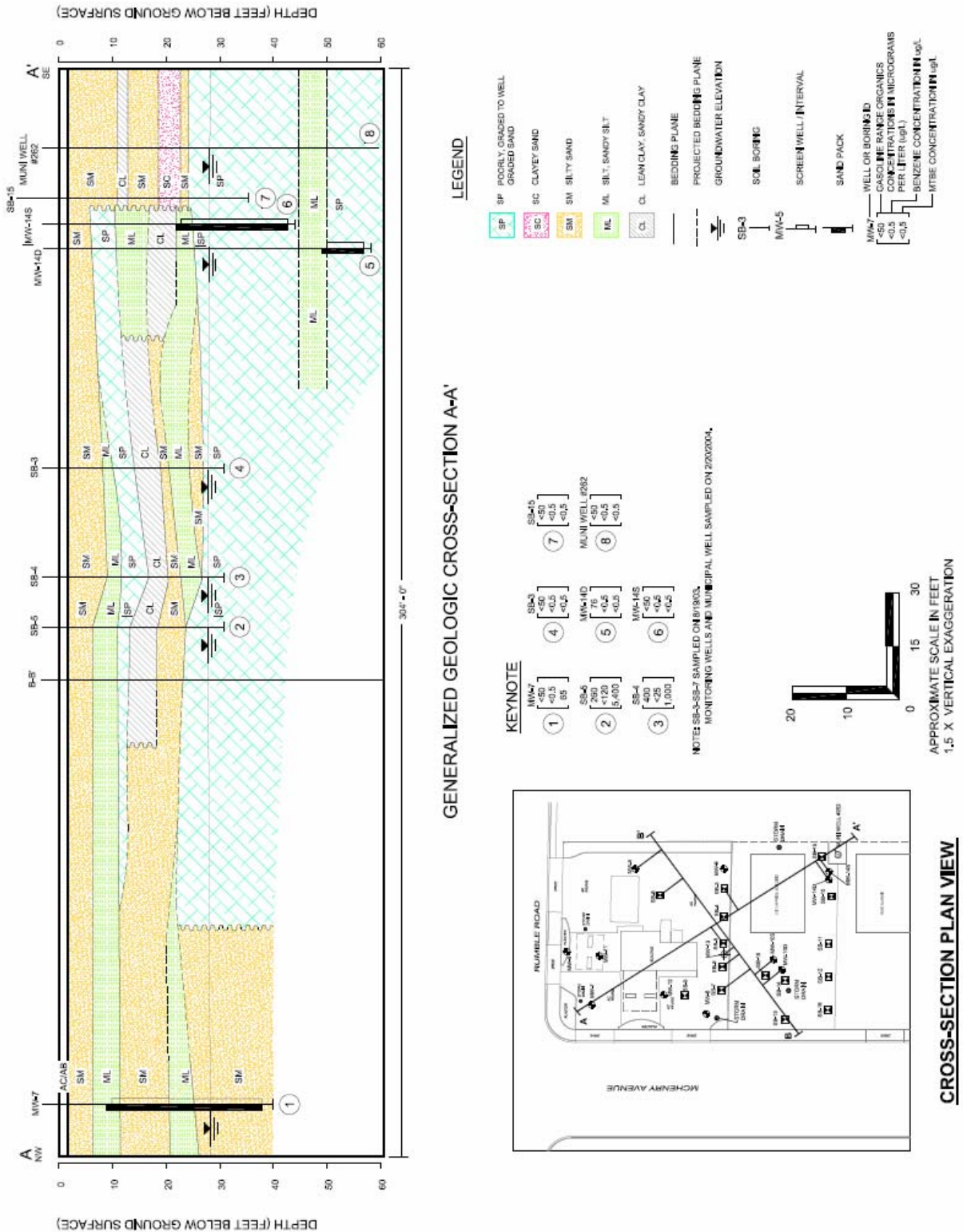

Figure 2. Generalized Geologic Cross-Section A-A'

2.1 Site Geology and Hydrogeology

Soils encountered during drilling activities consist of highly interbedded, poorly graded sand, clayey sand, silty sand, sandy silt, silt, sandy clay, and lean clay. A large clay lens exists from

approximately 12 to 16 feet bgs, and a bed of hard silt exists from approximately 45 to 49 feet bgs. Generalized geologic cross-sections are presented as Figures 3 and 4.

During past drilling activities, first water was encountered in poorly graded sand (between 27.5 and 29 feet bgs) that constitutes the surface of a shallow water-bearing zone. A deeper water-bearing zone was encountered at 49 feet bgs. Based on observations of historical quarterly groundwater monitoring data, the inferred direction of groundwater flow at the site ranges from the southwest to the south, at an average hydraulic gradient of 0.0002 to 0.001 feet per foot, toward the municipal supply well.

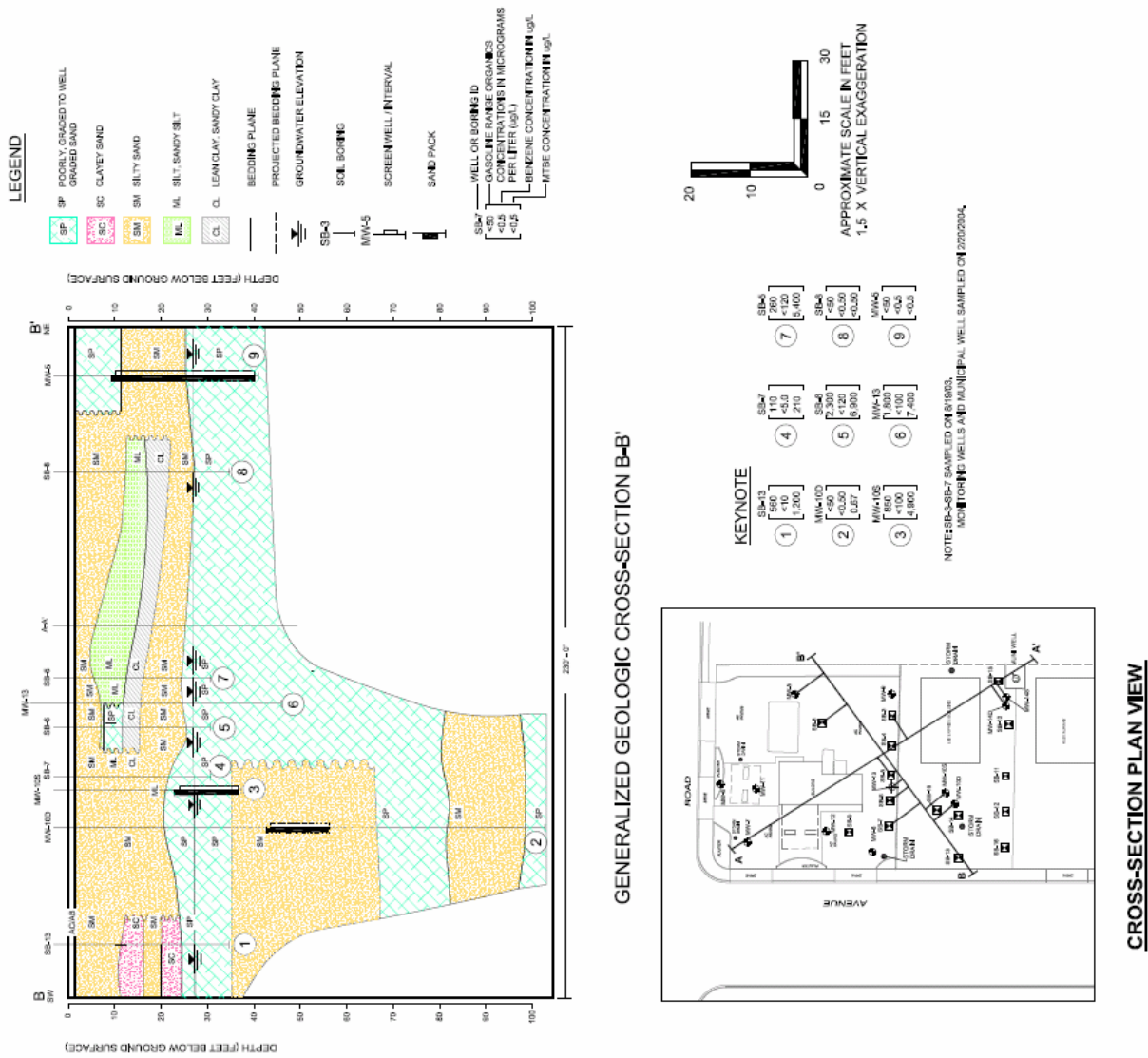

Figure 3. Generalized Geologic Cross-Section B-B'

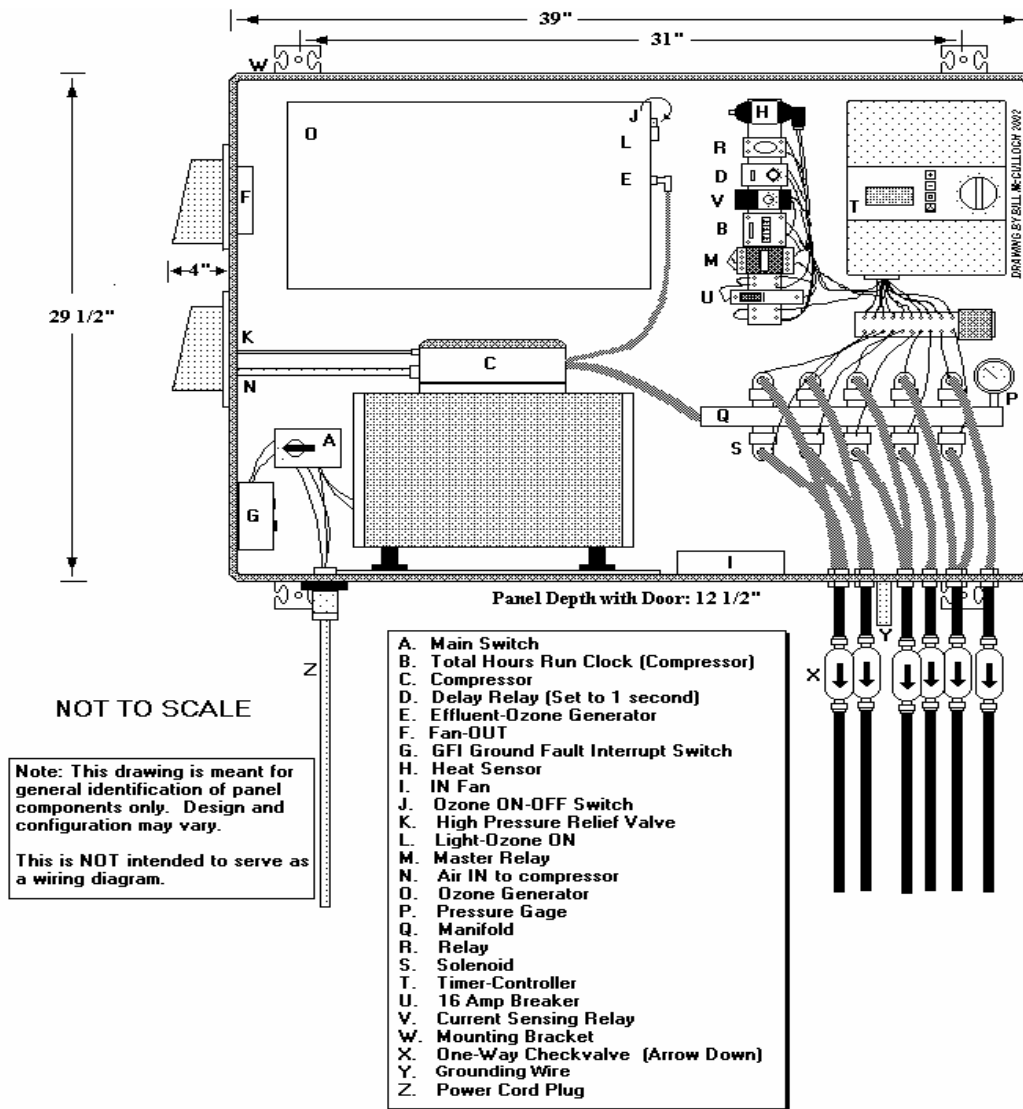

Figure 4a. The Air/Ozone KVA C-Sparger Panel. Schematic

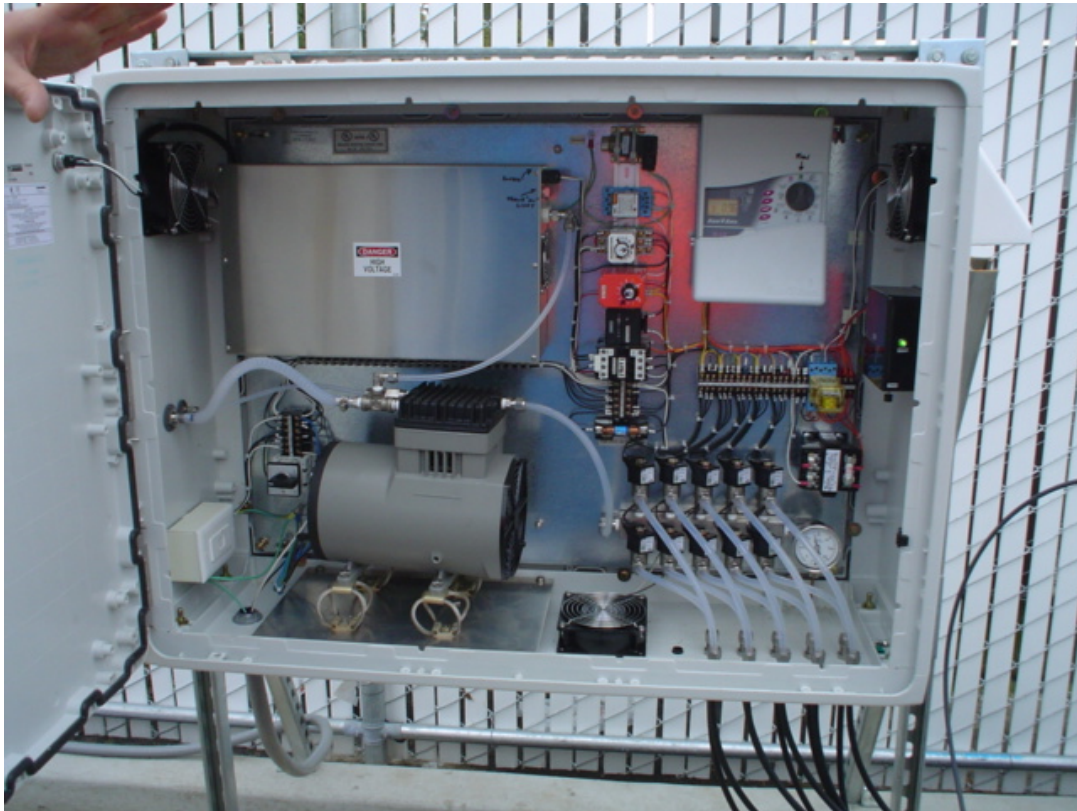

Figure 4b. The Air/Ozone KVA C-Sparger Panel. Field Application at Site 2063. The Panel is about 2' by 3' by 1'

3. REMEDIAL OBJECTIVES

Site remedial objectives were to (1) protect the existing municipal water supply well from a rapidly approaching plume from the site operation; (2) implement a remediation process that would not require pumping with topside treatment and discharge, since discharge to the local sewer was not available, according to the sewer district; and (3) implement a remediation process that is proven, readily implementable, efficient, and cost-effective. The approach URS used was to consider innovative *in situ* process operations that would be effective in the subsurface hydrogeologic conditions of California's Central Valley. Since this project was time-critical, URS relied heavily upon the hands-on experience of the remediation engineers.

3.1 Remediation Technologies Evaluation and Selection

Because soil and groundwater were contaminated, both media needed to be addressed. An estimated 3,500 pounds of GROs remained in soils. An estimated 13 pounds of GRO and 35 pounds of MTBE were present in the groundwater. For the vadose zone source area, two alternatives were evaluated: excavation with off-site disposal and SVE. Remedial alternatives considered for groundwater were groundwater pump-and-treat with off-site disposal, *in situ* chemical oxidation (air/ozone sparging), containment, air sparging, and monitored natural attenuation.

The technology alternatives were selected with due consideration to the immediate need to remediate petroleum-impacted soil and groundwater, to prevent migration of contaminants to the muni well. The final recommendation submitted in the Corrective Action Plan (CAP) was to implement SVE for soil remediation in conjunction with air/ozone sparging for groundwater remediation.

4. AIR/OZONE SPARGE SYSTEM DESIGN

The selected system is a panel-mounted air/ozone sparge system provided by McCulloch Equipment and manufactured by Kerfoot Technologies (2006). This section details the air/ozone sparging process, the sparge curtain, and the air/ozone sparge system supplied by Kerfoot Technologies.

4.1 Air/Ozone Sparge Process

Air/ozone sparging is the injection of ambient air with ozone into the saturated zone (below the groundwater table) to destroy contaminants *in situ*. Ozone is generated on site from ambient air using a method called corona discharge. In corona discharge, an electrical charge splits an oxygen molecule into two oxygen atoms. The resulting unstable oxygen atoms combine with other oxygen molecules to form ozone (O₃). From the corona discharge ozone generator, the air/ozone mixture is compressed for injection into the saturated zone. Once released into the aquifer, it oxidizes (destroys) contaminants *in situ*. Ozone is unstable and has a very high oxidizing potential; therefore, it will oxidize contaminants very rapidly then return to the more stable oxygen molecule. Any excess ozone will degrade back to the oxygen molecule in a relatively short time. Ozone's half-life in the presence of water is typically 30 minutes at standard temperatures and pressures. Because ozone is a gas, it can also be used for vadose zone remediation. However, this is not the intent at this site because of the installed SVE system. As a secondary effect, as the ozone degrades back to oxygen it can help stimulate aerobic biodegradation.

4.2 Air/Ozone Sparge Curtain

To best implement the air/ozone sparging technology and to protect the downgradient muni well, a sparge curtain was installed. As previously discussed, Figure 2 depicts the sparge curtain layout and its location on the gas station property. The sparge curtain was sited between the source area and the municipal well. By sparging in this fashion, the sparge points are still located on the service station property while also reducing the contaminant concentrations moving downgradient, as demonstrated in the historical analytical data. The curtain is composed of five wells located slightly less than 30 feet from each other. Each well is intended to have a radius of influence (ROI) of 15 feet, and contains one deep and one shallow sparge location—for a system total of 10 discrete sparge locations. Air/ozone sparge wells AOS-1 through AOS-10 were completed in their respective 8-inch diameter boreholes under the direction of a URS geologist. The wells were constructed using 0.75-inch inside-diameter (ID), Schedule 40, flush-threaded polyvinyl chloride (PVC) well casing. The 2-inch by 30-inch sparge points were installed on separate PVC casings, as follows:

Shallow sparge points were installed from 32 to 39.5 feet bgs.

Deep sparge points were installed from 42.5 to 50 feet bgs.

Sand filter packs were installed from the bottom of the borings to 2.5 above the deepest sparge points, and from 6 inches below the shallow sparge points to 2.5 feet above. Bentonite seals were placed between the deep and shallow sand packs and a 3-foot bentonite transition seal was placed in the annular space above the shallow sand packs. Neat cement grout was used to seal the remaining annular space to 1 foot bgs. The wells were completed with traffic-rated, flush-mounted, well vaults.

4.3 Air/Ozone Sparge System Components

The air/ozone sparging process used at the site has been developed by Kerfoot Technologies, and is called C-Sparge™ (as illustrated on Figure 5). This technology injects micro bubbles (approximately 50 µm in diameter) of encapsulated ozone directly into the groundwater. The micro bubbles are randomly dispersed through the water and the saturated soil formation. The process

combines stripping and treatment, targeting both soil (any contaminants sorbed to soil particles) and groundwater (dissolved-phase contaminants). The encapsulated ozone reacts with the contaminants, producing harmless byproducts such as water, carbon dioxide, and oxygen. The injection concentration and mass loading are low with this system, typically between 80 to 350 parts per million by volume (ppmv) and less than 1 pound per day, respectively. The air/ozone mixture injection is pulsed; the pulse frequency and duration are controlled by a timer located in the panel-mounted system, and optimized as contaminant concentrations are reduced.

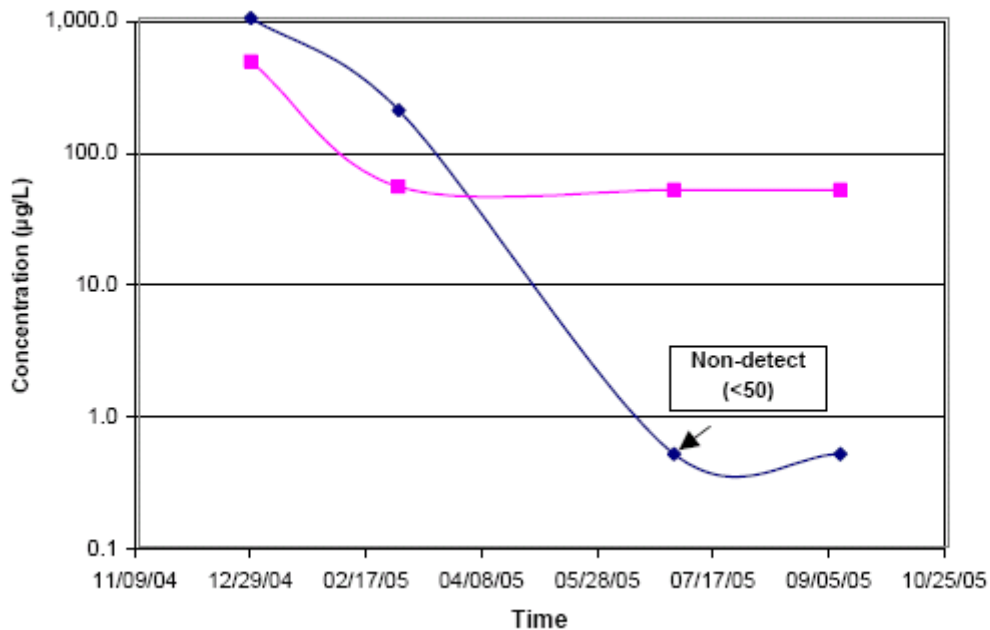

Figure 5. MW-10S Concentration (µg/L) vs. Time

5. AIR/OZONE DESIGN SPECIFICS

Once URS proposed installing the *in situ* air/ozone sparge process, the Lead Enforcement Agency (LEA) requested a pilot test work plan and more information on the innovative process operation, since they suspected it could generate deleterious secondary compounds. URS (2004) agreed to conduct a pilot test designed to satisfy the LEA's directives and comments. Pilot test activities included soil sample collection to analyze for content of a specified list of elements from soil, groundwater sample collection and analysis to determine whether deleterious secondary compounds could be generated as the result of sparging, and assessment of system efficiency for remediation of gasoline-related hydrocarbons.

5.1 Stoichiometry, or Chemical Equations

Design Request: Provide stoichiometry or chemical equations for the reaction between the soil and groundwater and the injected ozone.

In general terms, the chemical oxidation of petroleum compounds ultimately breaks the targeted organic compound down into carbon dioxide and water.

For hydrocarbons, the generalized stoichiometry equation is:

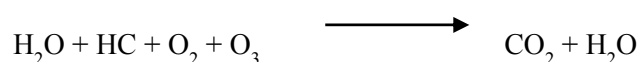

Where "HC" designates petroleum compounds (i.e., hydrocarbons).

Ideally, the generalized stoichiometry equation for the complete oxidation of MTBE is:

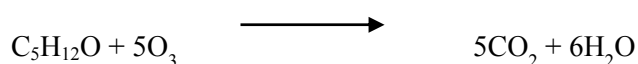

5.2 Soils Testing

Design Request: Provide results of a leachability testing of native soils, to determine the potential effects from the ozone injection. General mineral analyses should be conducted to evaluate if naturally occurring minerals will move into solution as a result of the ozone injection. The following general mineral suite should be evaluated: aluminum, antimony, arsenic, barium, beryllium, cadmium, calcium, chromium (III and VI), cobalt, copper, iron, lead, magnesium, manganese, mercury, molybdenum, nickel, potassium, selenium, silver, sodium, thallium, tungsten, vanadium, and zinc.

URS clarified the requests in the Stanislaus County Department of Environmental Resources (SCDER) letter, dated July 16 2004, in regard to item “2B soil leachability testing.” URS communicated with the Regional Water Quality Control Board, Central Valley Region (RWQCB-CVR) on August 3, 2004 and the SCDER on August 4, 2004. URS, RWQCB-CVR, and SCDER agreed that requests made in Item 2B of the SCDER letter would be satisfied by conducting analyses of specified mineral/element content for soil samples to be collected during air/ozone sparge point installation.

As the sparge point borings were drilled, at least three soil samples were collected for the analyses requested, as follows:

General elements/minerals referenced in the SCDER letter dated July 2004, include metals by the United States Environmental Protection Agency (EPA) Method 200.7/7471A, chromium (IV) by EPA Method 7199, general anions by EPA Method 300.0, and $-\log [\text{H}^+]$ (pH) by EPA Method 9045.

5.3 Groundwater Sampling and Analyses

Design Request: Provide results of general mineral analyses of the groundwater. Results from this analysis should be used to evaluate if naturally occurring minerals will precipitate out of the groundwater as a result of the ozone injection. The following general mineral suite should be evaluated: aluminum, antimony, arsenic, barium, beryllium, cadmium, calcium, chromium (III and VI), cobalt, copper, iron, lead, magnesium, manganese, mercury, molybdenum, nickel, potassium, selenium, silver, sodium, thallium, tungsten, vanadium, and zinc.

Groundwater samples were collected at three intervals for the pilot test including, *Time Zero* – prior to the air/ozone sparge testing, *Time 4 Hours* – after the air/ozone sparge test has been initiated and *Time Day 3* – after the air/ozone sparge test has been initiated (assuming that no deleterious compounds were reported from the *Time 4 Hours* test result).

The groundwater was analyzed for electrical conductivity (EC), total dissolved solids (TDS) and pH, using a calibrated handheld meter:

Groundwater samples were analyzed for the general elements referenced in the SCDER letter dated July 2004, including: metals (including mercury) by EPA Method 200.7/7470A, chromium (IV) will be analyzed by EPA Method 7199, general anions will be analyzed by EPA Method 300.0.

The generation of deleterious secondary compounds is not anticipated.

5.4 Estimate the Mass of Constituents Released to the Aquifer

Design Request: Provide an estimate of the mass of other constituents/parameters, including Electrical Conductivity (EC), chlorides, sulfides, etc. which will be released into the aquifer as a result of the ozone injection, and the rationale for the estimate.

Any measurable amounts or significant difference in the pre-air/ozone sparging versus post-air/ozone sparging concentrations for the EC, chlorides, or sulfates were not anticipated and did not appear.

5.5 Estimate the Mass of TDS

Design Request: Provide an estimate of the mass of TDS that will be mobilized by the injection of the ozone, and the rationale for the estimate.

Any measurable amounts or significant difference in the pre-air/ozone sparging versus post-air/ozone sparging concentrations for TDS was not anticipated and did not appear.

5.6 Estimate Changes in pH

Design Request: Provide estimates of changes in pH in groundwater and the radius of influence for the proposed ozone injection.

Any measurable amounts or significant difference in the pre-air/ozone sparging versus post-air/ozone sparging concentrations for pH was not anticipated and did not appear. The minimum estimated ROI is 20 feet.

5.7 Assess Site-Specific Effectiveness for Air/Ozone Sparging

Design Request: Provide an assessment of the site specific effectiveness of ozone sparging for eliminating identified soil and groundwater contamination in this case, and identify/demonstrate that any breakdown products of this process (e.g., acetone and/or degradation products) are analyzed for and addressed by the planned remediation.

Pilot Test details are presented below, under Pilot Test Procedure. In summary, during sparger installation, soil samples from the vadose zone and saturated zone were collected for analysis. Groundwater samples were obtained and sent for analyses at *Time Zero*, before the air/ozone sparge test; *Time 4 Hours* – during the air/ozone sparge test, and *Time, Day 3* – during the air/ozone sparge test.

The specific effectiveness of the air/ozone sparging was presented in a letter report to the SCDER and RWQCB for review and comment. URS' previous experience with this technology, along with the pilot test results, demonstrated dramatic positive effects on subsurface gasoline-related hydrocarbon reductions.

6. PILOT TEST PROCEDURE

The pilot scale test procedure was developed using the guidelines provided in the SCDER letter dated July 16, 2004. It was conducted under the supervision of a URS licensed Professional Engineer and a URS Geologist. The letter required that sites with *in situ* air/ozone sparging as the recommended remedial process be tested with a full-scale pilot test in lieu of a lab bench-scale test procedure. This test procedure assessed whether the recommended remediation process altered the aquifer water chemistry or generated deleterious secondary compounds during the oxidation process.

The pilot test activities included background groundwater sampling and analyses, installation of all air/ozone sparge equipment and start-up of the air/ozone sparge equipment. The field test was conducted as described below:

Pre-sparge water samples were collected and analyzed in accordance with the analyses specified; additionally, URS tested a water sample for EC, TDS and pH, using a calibrated handheld meter.

Air/ozone sparging was initiated at the lower sparge location in SW-2B for two hours.

A downhole video camera was employed in MW-13 to assess and record the location and interception of the air/ozone bubbles at the well screen. The location of the bubble flux intercept was recorded such that the phi angle and radius of influence were calculated and recorded.

Initiated air/ozone sparging at the upper sparge location in SW-2 (SW-2A) for two hours.

Deployed downhole video camera in well MW-13 to assess and record the location and interception of the air/ozone bubbles at the well screen. The location of the bubble flux intercept was recorded such that the phi angle and radius of influence were calculated and recorded.

When the air/ozone sparge system operated for a total of four hours, URS obtained a groundwater sample from MW-13; the water sample was analyzed according to the analyses specified previously; additionally, URS tested a water sample for EC, TDS, and pH with a calibrated handheld meter.

Initiated air/ozone sparging at the lower sparge location in SW-3 (SW-3B) for two hours.

Deployed downhole video camera in MW-13 to assess and record the location and interception of the air/ozone bubbles at the well screen. The location of the bubble flux intercept was recorded such that the phi angle and radius of influence was calculated and recorded.

URS decided not to utilize the camera on other monitoring wells in the immediate vicinity since the sparge bubbles could be seen clearly.

The *four-hour groundwater sample results* were reviewed as soon as practical for compounds that may have been inadvertently generated during the initial four-hour sparging activity. These results showed that no deleterious compounds were produced.

Initiated air/ozone sparging at the upper sparge location in SW-3 (SW-3A) for two hours.

Deployed downhole video camera in MW-13 to assess and record the location and interception of the air/ozone bubbles at the well screen. The location of the bubble flux intercept was recorded such that the phi angle and radius of influence was calculated and recorded.

The groundwater results did not show that deleterious compounds were generated as a result of the air/ozone system.

The air/ozone sparge system operated for an additional three days. URS obtained a groundwater sample from MW-13; the water sample was analyzed in accordance with the analyses specified in C above; additionally, URS tested a water sample for EC, TDS, and pH with a calibrated handheld meter.

Continued the air/ozone sparging at the four locations on a cyclical basis in SW 2A, SW-2B, SW-3A, and SW-3B for equal time periods.

The three-day groundwater sample results were reviewed as soon as practical for compounds that may have been inadvertently generated during the initial three-day sparging activity. These results did not show that generation of deleterious compounds were generated as a result of the sparging activities.

7. REMEDIATION SYSTEM RESULTS AND CONCLUSIONS

The SVE system was operated between December 2004 and March 2006, slightly more than 14 months, then shut down for rebound testing. Ozone treatment took place between February 2005 and September 2005, a total of about seven months. Groundwater sampling results are presented in Table 1. Figures 5, 6 and 7 graph MTBE and TPHg, show concentration time at three select monitoring wells. Figures 8, 9 and 10 are plume maps showing the aerial extent of MTBE and TPHg concentrations in groundwater. Both the data and the figures illustrate the dramatic reduction in MTBE and TPHg concentrations resulting from system operation, and verify the lack of rebound of either contaminant.

Table 1. Complete Analytical Results For TPH-g and MTBE

| Well Number | Date Sampled | TPH-g [$\mu\text{g/L}$] | MTBE [$\mu\text{g/L}$] | Hexavalent Chromium [$\mu\text{g/L}$] |
|-------------|--------------|---------------------------|--------------------------|---|
| Muni Well | 12/27/2004 | -- | -- | -- |
| | 01/10/2005 | <50 | <0.50 | -- |
| | 02/11/2005 | <50 | <0.50 | -- |
| | 03/01/2005 | <50 | <0.50 | -- |
| | 04/06/2005 | <50 | <0.50 | -- |
| | 04/20/2005 | <50 | <0.50 | -- |
| | 06/28/2005 | <50 | <0.50 | -- |
| | 07/21/2005 | -- | -- | -- |
| | 08/01/2005 | <50 | <0.50 | -- |
| | 09/08/2005 | <50 | <0.50 | -- |
| | 09/22/2005 | -- | -- | 3.4 |
| | 12/21/2006 | <50 | <0.50 | 1 |

| Well Number | Date Sampled | TPH-g [µg/L] | MTBE [µg/L] | Hexavalent Chromium [µg/L] |
|-------------|--------------|--------------|-------------|----------------------------|
| MW-5 | 3/21/2006 | <50 | <0.50 | <0.50 |
| | 6/20/2006 | <50 | <0.50 | 5.3 |
| | 12/27/2004 | <50 | <0.50 | -- |
| | 03/01/2005 | <50 | <0.50 | -- |
| | 06/28/2005 | <50 | <0.50 | -- |
| | 09/08/2005 | <50 | <0.50 | -- |
| | 09/22/2005 | -- | -- | 5.2 |
| | 12/21/2006 | <50 | <0.50 | -- |
| | 3/21/2006 | <50 | <0.50 | -- |
| MW-6 | 6/20/2006 | <50 | <0.50 | -- |
| | 12/27/2004 | <50 | <0.50 | -- |
| | 03/01/2005 | <50 | <0.50 | -- |
| | 06/28/2005 | <50 | <0.50 | -- |
| | 09/08/2005 | <50 | <0.50 | -- |
| | 12/21/2006 | <50 | <0.50 | -- |
| MW-7 | 3/21/2006 | <50 | <0.50 | -- |
| | 6/20/2006 | <50 | <0.50 | -- |
| | 12/27/2004 | <50 | 39 | -- |
| | 03/01/2005 | <50 | 23 | -- |
| | 06/28/2005 | <50 | <0.50 | -- |
| | 09/08/2005 | <50 | <0.50 | -- |
| | 12/21/2006 | <50 | 13 | -- |
| MW-8 | 3/21/2006 | <50 | <0.50 | -- |
| | 6/20/2006 | <50 | <0.50 | -- |
| | 12/27/2004 | <50 | 1.0 | -- |
| | 03/01/2005 | <50 | <0.50 | -- |
| | 06/28/2005 | <50 | <0.50 | -- |
| | 09/08/2005 | <50 | <0.50 | -- |
| MW-9 | 12/21/2006 | <50 | <0.50 | -- |
| | 3/21/2006 | <50 | <0.50 | -- |
| | 6/20/2006 | <50 | <0.50 | -- |
| | 12/27/2004 | <50 | <0.50 | -- |
| | 01/31/2005 | -- | -- | 2.5 |
| | 03/01/2005 | <50 | <0.50 | -- |
| | 06/28/2005 | <50 | <0.50 | -- |
| | 09/08/2005 | <50 | <0.50 | 1.8 |
| 09/22/2005 | -- | -- | 2.9 | |
| MW-10D | 12/21/2006 | <50 | <0.50 | 0.77 |
| | 3/21/2006 | <50 | <0.50 | 1.1 |
| | 6/20/2006 | <50 | <0.50 | 1.2 |
| | 12/27/2004 | <50 | 0.67 | -- |
| | 03/01/2005 | <50 | 0.65 | -- |
| | 06/28/2005 | <50 | <0.50 | -- |
| | 09/08/2005 | <50 | <0.50 | 45* |
| | 09/22/2005 | -- | -- | 9.7 |
| MW-10S | 12/21/2006 | <50 | <0.50 | 5 |
| | 3/21/2006 | <50 | <0.50 | 15 |
| | 6/20/2006 | <50 | <0.50 | 17 |
| | 12/27/2004 | 470 | 1,000 | -- |
| | 03/01/2005 | 53 | 200 | -- |
| | 06/28/2005 | <50 | <0.50 | -- |
| | 09/08/2005 | <50 | <0.50 | 1.1 |
| MW-11 | 09/22/2005 | -- | -- | 1.1 |
| | 12/21/2006 | <50 | <0.50 | 5.2 |
| | 3/21/2006 | <50 | <0.50 | 0.9 |
| | 6/20/2006 | <50 | <0.50 | 4 |
| | 12/27/2004 | 33,000 | 30,000 | -- |
| | 03/01/2005 | 590 | 190 | -- |
| 06/28/2005 | 170 | 49 | -- | |

| Well Number | Date Sampled | TPH-g [µg/L] | MTBE [µg/L] | Hexavalent Chromium [µg/L] |
|-------------|--------------|--------------|-------------|----------------------------|
| | 09/08/2005 | <500 | 340 | <0.50 |
| | 09/22/2005 | -- | -- | <0.50 |
| | 12/21/2006 | <50 | 40 | <0.50 |
| | 3/21/2006 | <50 | 3.2 | <0.50 |
| | 6/20/2006 | <50 | 9.9 | <0.50 |
| MW-12 | 12/27/2004 | 50 | 23 | -- |
| | 03/01/2005 | 660 | 400 | -- |
| | 06/28/2005 | 110 | 6.1 | -- |
| | 09/08/2005 | 180 | 7.6 | -- |
| | 12/21/2006 | <50 | 1.7 | -- |
| | 3/21/2006 | <50 | 1.5 | -- |
| | 6/20/2006 | <50 | 1.5 | -- |
| MW-13 | 12/27/2004 | 490 | 970 | -- |
| | 01/31/2005 | -- | -- | 0.80 |
| | 03/01/2005 | <50 | 1.5 | -- |
| | 06/28/2005 | <50 | <0.50 | -- |
| | 09/08/2005 | <50 | <0.50 | 4.0 |
| | 09/22/2005 | -- | -- | 4.6 |
| | 12/21/2006 | <50 | <0.50 | 0.97 |
| | 3/21/2006 | <50 | <0.50 | <0.50 |
| MW-14D | 6/20/2006 | <50 | <0.50 | <0.50 |
| | 12/27/2004 | <50 | <0.50 | -- |
| | 01/10/2005 | <50 | <0.50 | -- |
| | 02/11/2005 | <50 | <0.50 | -- |
| | 03/01/2005 | <50 | <0.50 | -- |
| | 04/06/2005 | <50 | <0.50 | -- |
| | 04/20/2005 | <50 | <0.50 | -- |
| | 06/28/2005 | <50 | <0.50 | -- |
| | 07/21/2005 | <50 | <0.50 | -- |
| | 08/01/2005 | <50 | <0.50 | -- |
| | 09/08/2005 | <50 | <0.50 | -- |
| | 09/22/2005 | -- | -- | 1.3 |
| | 12/21/2006 | <50 | <0.50 | <0.50 |
| | 3/21/2006 | <50 | <0.50 | 0.92 |
| 6/20/2006 | <50 | <0.50 | 1.7 | |
| MW-14S | 12/27/2004 | <50 | <0.50 | -- |
| | 01/10/2005 | <50 | <0.50 | -- |
| | 02/11/2005 | <50 | <0.50 | -- |
| | 03/01/2005 | <50 | <0.50 | -- |
| | 04/06/2005 | <50 | <0.50 | -- |
| | 04/20/2005 | <50 | <0.50 | -- |
| | 06/28/2005 | <50 | 0.62 | -- |
| | 07/21/2005 | <50 | 0.70 | -- |
| | 08/01/2005 | <50 | <0.50 | -- |
| | 09/08/2005 | <50 | <0.50 | -- |
| | 09/22/2005 | -- | -- | 3.5 |
| | 12/21/2006 | <50 | <0.50 | 1.5 |
| | 3/21/2006 | <50 | <0.50 | 0.5 |

Notes: * Result did not confirm upon resampling

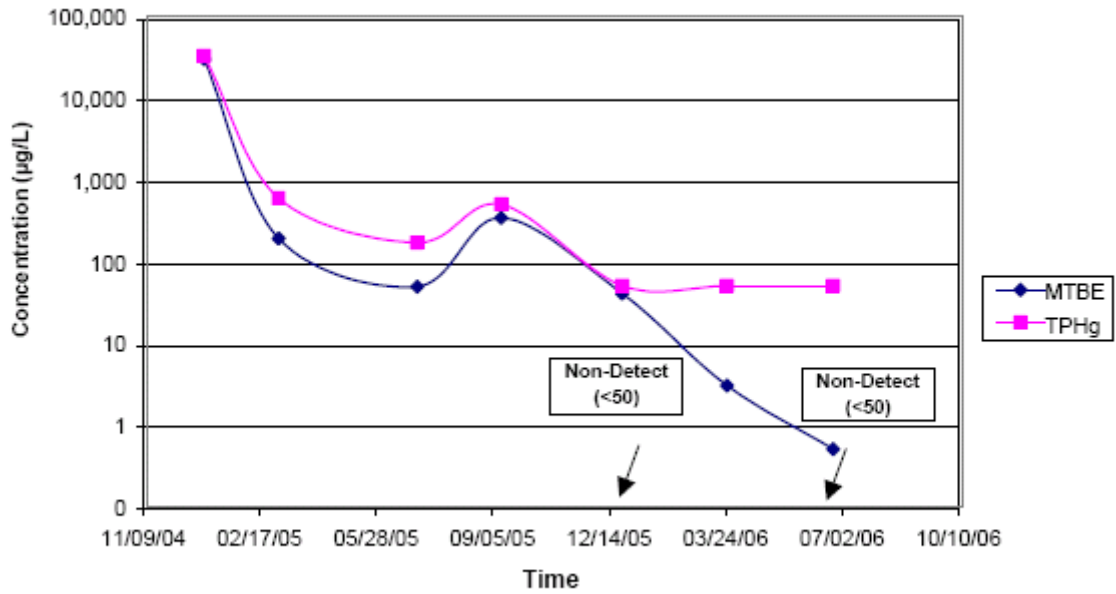

Figure 6. MW-11 (Source Area) Concentration (µg/L) vs. Time. (Note: TPHg data was non-detect, <500 but not included because of high reporting limit)

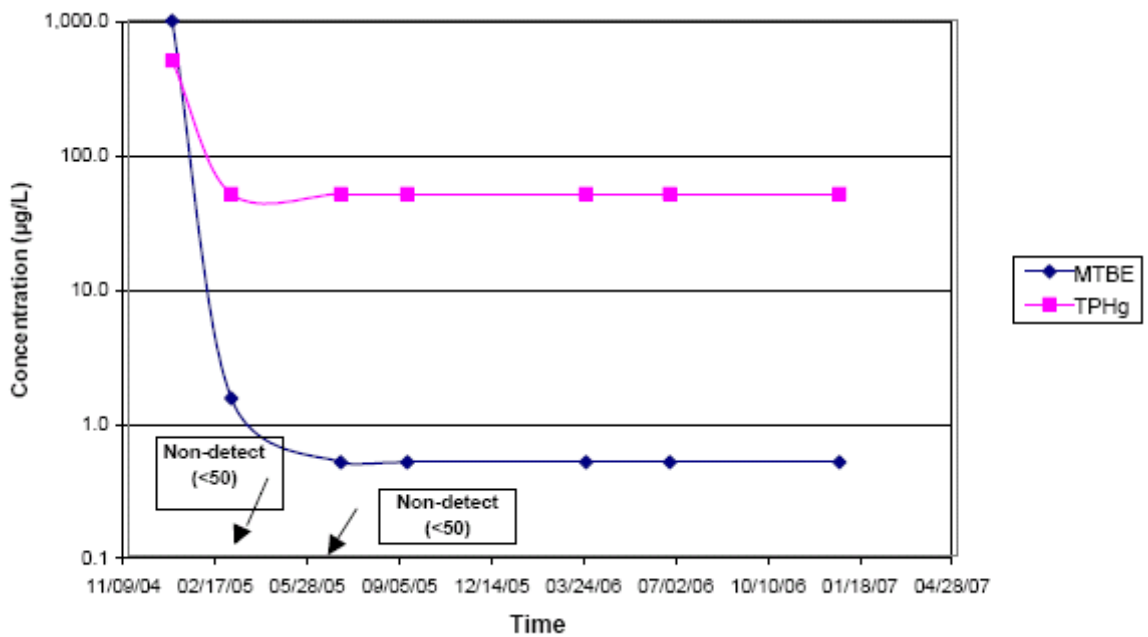

Figure 7. MW-13 (Near Sparge Curtain) Concentration (µg/L) vs. Time

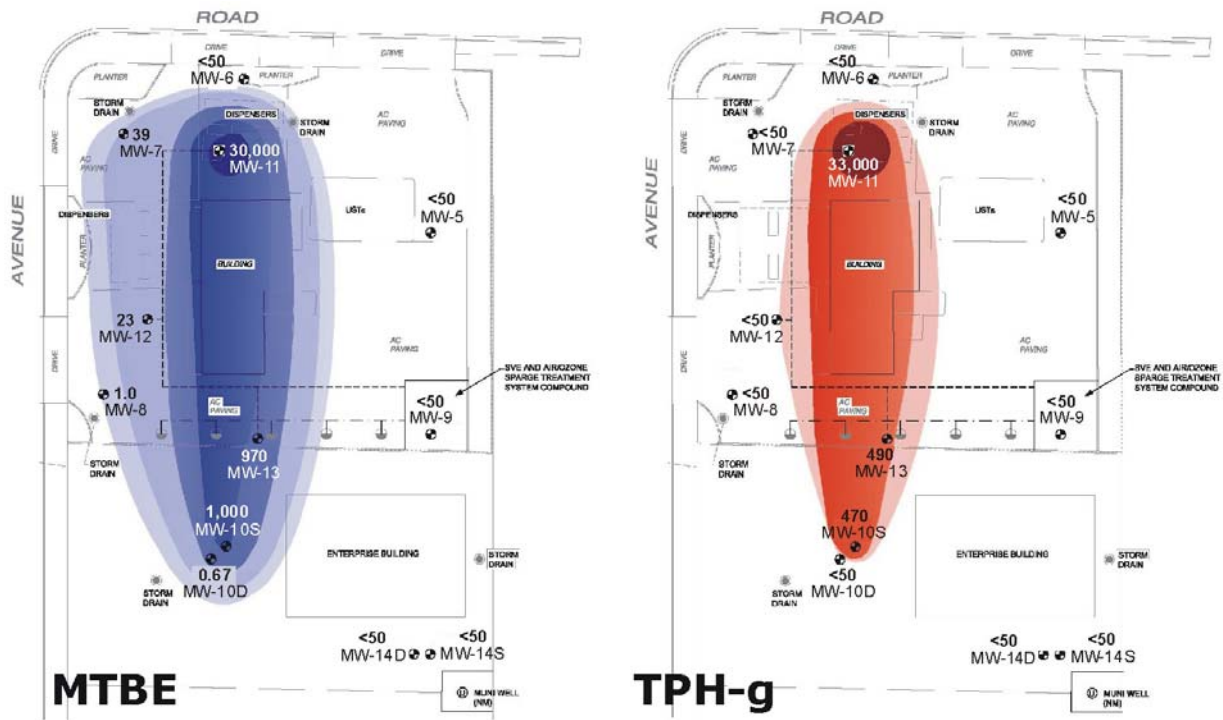

Figure 8. 30 Days before Remediation Startup, December 2004. MTBE in Groundwater (µg/L) and TPH-g in Groundwater (µg/L)

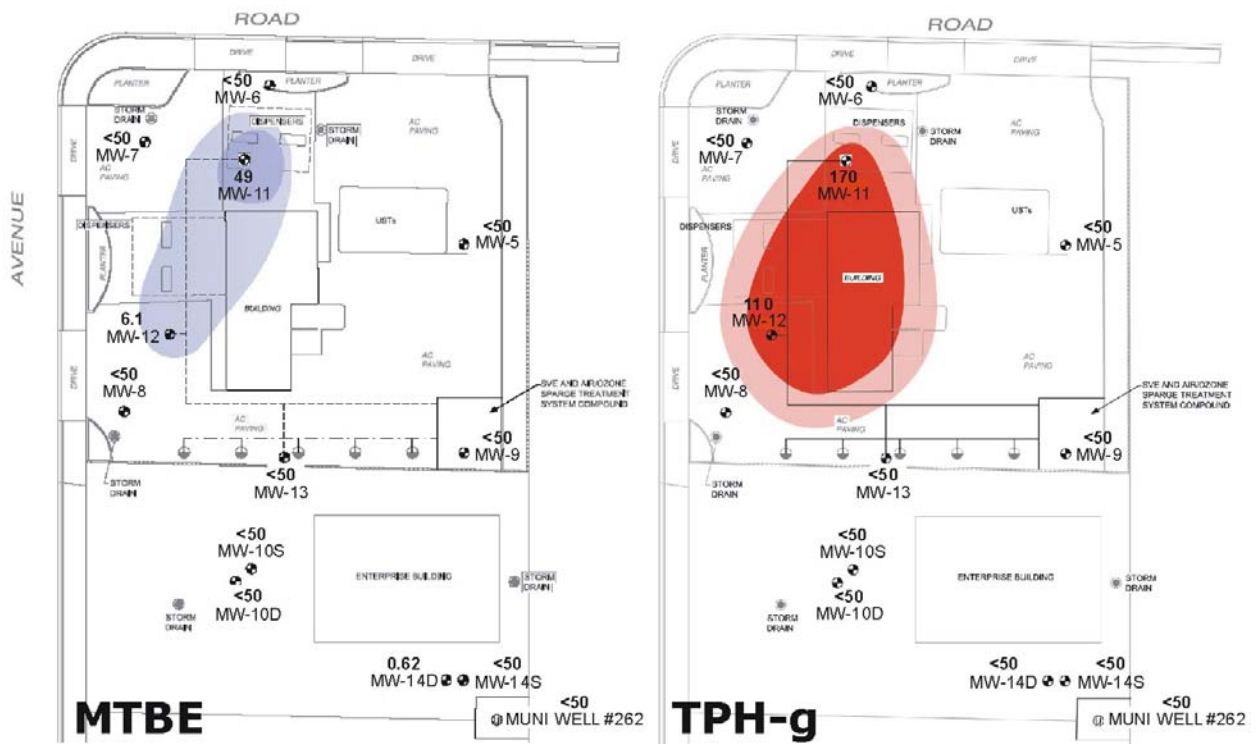

Figure 9. After 150 Days Operating, June 2005. MTBE in Groundwater (µg/L) and TPH-g in Groundwater (µg/L)

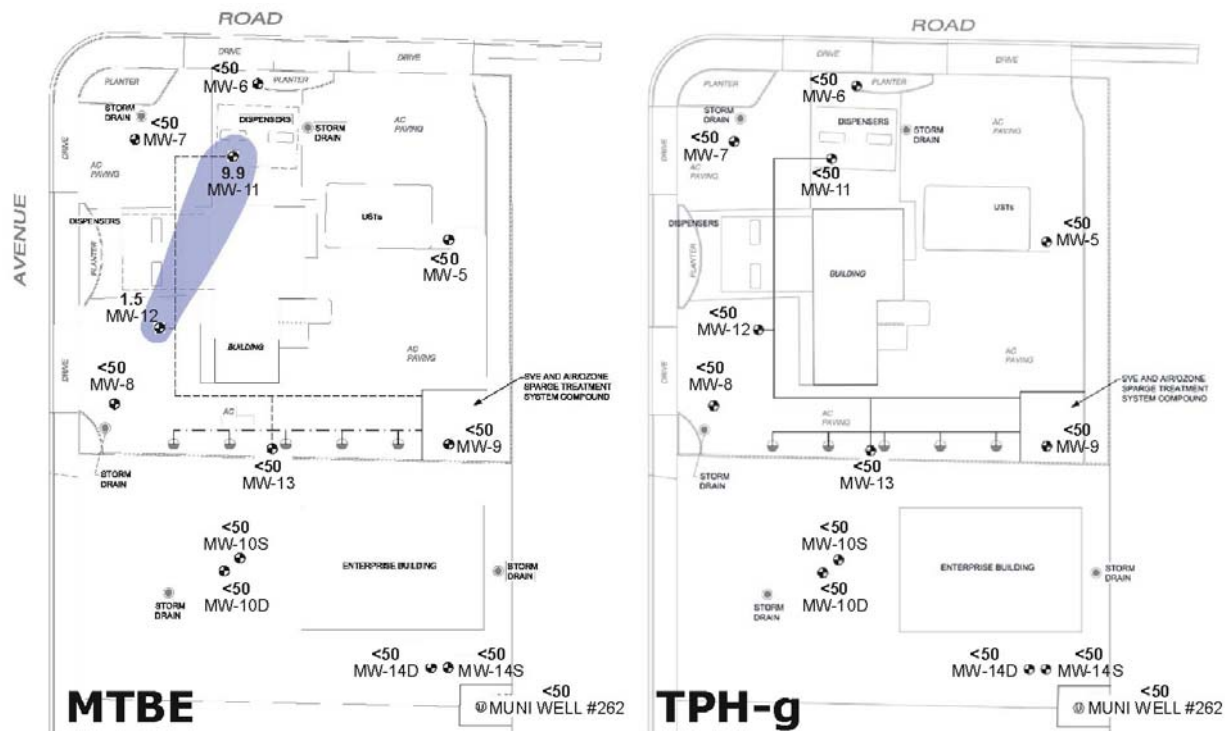

Figure 10. After 17 Months Operating, June 2006. MTBE in Groundwater ($\mu\text{g/L}$) and TPH-g in Groundwater ($\mu\text{g/L}$)

In summary, URS has concluded the following:

The air/ozone sparge curtain worked effectively and afforded excellent protection to the municipal supply well.

The groundwater monitoring well results show that the aquifer has some small concentrations of total chromium and hexavalent chromium as indicated in the upgradient monitoring well and pre-system operation results. These total chromium and hexavalent chromium results are considered naturally occurring and represent background conditions.

The current MTBE and TPHg concentrations are non-detectable (ND) based on a laboratory reporting limit of $0.5 \mu\text{g/L}$ for MTBE and $50 \mu\text{g/L}$ for TPHg in the immediate vicinity of the sparge curtain and 90 feet upgradient to MW-11 and 100 feet downgradient to MW-14D and MW-14S. Based on these results, site closure is expected following further monitoring.

REFERENCES

- Interstate Technology & Regulatory Council. 2005. Technical and Regulatory Guidance for In Situ Chemical Oxidation of Contaminated Soil and Groundwater. Second Edition. January.
- Kerfoot Technologies, Inc. 2006. <http://www.kva-equipment.com>.
- URS Corporation. 2004. Work Plan for Air/Ozone Sparging Remediation System Pilot Test, August.

PART X: Risk Assessment

Chapter 30

IMPACT OF AGING TIME ON THE RISK FROM DERMAL EXPOSURE TO SOIL CONTAMINATED WITH PHENANTHRENE

Soil-aged Phenanthrene Dermal Exposure Risk

Mohamed S. Abdel-Rahman¹, Gloria A. Skowronski¹, and Rita M. Turkall^{1,2}

University of Medicine and Dentistry of New Jersey,¹Pharmacology and Physiology Department, New Jersey Medical School and ²Clinical Laboratory Sciences Department, School of Health Related Professions

Abstract: The health risk from exposure to contaminated soil is related to the fraction of chemical absorbed by the body (bioavailability), rather than to the total concentration of chemical in soil. Chemical bioavailability data are necessary to improve the accuracy of risk assessment following exposure to contaminated soil and to allow more realistic soil remediation goals. One of the factors that may influence chemical bioavailability and ultimately health risk from exposure is the residence time or “aging” of chemical in soil. Skin is a primary route of exposure to phenanthrene, a polycyclic aromatic hydrocarbon found in soil at former manufactured gas plant sites. This study was conducted to determine the extent to which soil alters the dermal bioavailability of phenanthrene with respect to soil aging and soil type. Bioavailability was assessed by measuring the penetration of phenanthrene through dermatomed male pig skin via an in vitro approach consisting of radiotracer and flow-through diffusion cell methodology. After 3 months aging, dermal penetration was significantly decreased by 83% in Atsion soil (high sand and high organic matter content) and by 69% in Keyport soil (high clay but low organic matter content) versus pure phenanthrene (without soil). By extending the aging time to 6 months, penetration through skin was reduced by 94% in Atsion soil and 86% in Keyport soil. The results indicate that because human risk from exposure to soil contaminated with phenanthrene would be reduced by aging, less soil cleanup would be needed.

Key words: bioavailability, polycyclic aromatic hydrocarbon, skin, matrix effects

1. INTRODUCTION

Polycyclic aromatic hydrocarbons (PAHs) are ubiquitous contaminants of soil and are derived chiefly from the incomplete combustion of organic materials. Soils that contain waste from manufactured gas plant sites, petroleum refineries, and wood preserving facilities are among the most heavily contaminated with PAHs (Harvey, 1991; ATSDR, 1995; Loehr and Webster, 1997). The fate of PAHs in soil has caused increasing concern due to their toxic, mutagenic, and carcinogenic effects (Karimi-Lotfabad et al., 1996). Health risk assessments are often based on exposure to the total concentration of a chemical in a contaminated site. The total concentration is usually determined by rigorous extraction procedures such as acid digestion, sonication, or Soxhlet extraction to remove the chemicals from soil (USEPA, 1986, 1992; Tang et al., 1999). However, this approach can result not only in an overestimation of risk, if the total amount of a chemical is not available to the body, but also in unnecessary and costly soil cleanup.

When humans are exposed to a chemical in soil, only a fraction of the total concentration (the bioavailable fraction) may be absorbed into the systemic circulation and reach the target site. It is the bioavailable amount that determines if chemical exposure produces a toxic effect or the extent of that effect. Therefore, it is important to determine the bioavailability of a chemical in soil to improve the accuracy of risk assessment following exposure to contaminated soil affording more realistic assessments of health effects and of soil remediation goals.

A number of factors can influence chemical sorption to soil and subsequently affect bioavailability. These factors include soil properties (e.g. percent organic matter, clay content, pH, and particle size) (Karickhoff et al., 1979; Duffus, 1980; NEPI, 2000; Pu et al., 2004); chemical properties (such as lipophilicity and volatility) (Ibbotson et al., 1989), as well as chemical aging in soil (Alexander, 2000).

The movement of chemicals from the surface of soil particles into less accessible sites where they become sequestered over a period of time has been termed "aging" (Linz and Nakles, 1997; Reid et al., 2000). It is believed that during chemical aging, hydrophobic molecules move slowly into soil organic matter. Because soil organic matter is very heterogeneous and contains both nanopores and regions that vary in polarity, density, and degree of coiling (Aochi and Farmer, 1997), it has been proposed that hydrophobic molecules can become sequestered in the nanopores as well as the solid phase of the organic matter so that they are no longer readily accessible (Alexander, 2000). Chemical aging in soil has been shown for organic compounds (Steinberg et al., 1987; Bowmer, 1991; Scribner et al., 1992; Hatzinger and Alexander, 1995; Kelsey et al., 1997; Robertson and Alexander, 1998; Roy and Singh, 2001; Abdel-Rahman et al., 2002, 2004, 2006) as well as for heavy metals (Lock and Janssen, 2003; Turpeinen et al., 2003; Abdel-Rahman et al., 2005).

The present study focused on the effects of aging on the dermal bioavailability of phenanthrene in soil. Phenanthrene is a major polycyclic aromatic hydrocarbon emitted in coal and fossil fuel combustion. It is found in coal combustion wastes such as coal tar, which has contaminated soils globally at sites where gas was formally manufactured (Laor et al., 1999; Pu et al., 2004). With the advent of natural gas pipelines, the gas manufacturing plants were shut down and the tars were generally left on site or buried in landfills (Wyzga and Goldstein, 1994). The composition of various coal tars depends on the source of the coal tar and the methods of processing. For example, when Chu et al. (1988) investigated the subchronic dermal toxicity of a medium-boiling (bp 154-378°C) coal liquefaction product in the rat, they found that the predominant polycyclic aromatic hydrocarbon was phenanthrene, comprising 27% w/w of the total chemical composition. Smaller amounts of fluorene, fluoranthrene, acenaphthene, 2-methylanthracene, pyrene, and 9,10-dihydrophenanthrene were also present. There are 868 hazardous waste sites contaminated with phenanthrene in the United States (ATSDR, 2006). Soil concentrations of phenanthrene at contaminated sites can range from 150 - 716 mg/kg dry weight at former manufactured gas plant sites to 11 - 4,434 mg/kg at sites related to wood preservation processes (Wilson and Jones, 1993).

Phenanthrene can be inhaled from exposure to coal, wood, and cigarette smoke; and from gasoline and diesel engine exhaust. Phenanthrene is also present in charcoal-broiled food. However, the most likely route of exposure to phenanthrene in contaminated soil is via the dermal route. Other sources of dermal exposure to phenanthrene include waste water, used motor oil, crude oils, and lubricating oils (IARC, 1983; ATSDR, 1995).

Acute health effects may occur immediately or shortly after dermal exposure to phenanthrene. The skin can become irritated. If skin contaminated with phenanthrene is exposed to sunlight, a rash or skin burn may occur, sometimes with blisters. Chronic health effects can occur some time after exposure to phenanthrene and can last for months or years. If a skin allergy develops, very low future exposure can cause itching and a skin rash (NJDHSS, 1999).

The aim of this study was to assess the bioavailability of phenanthrene in soil by measuring the dermal penetration of the chemical. First, the dermal penetration of phenanthrene in freshly spiked soil was compared to the dermal penetration of pure phenanthrene (without soil). Although bioavailability data for freshly spiked soil can overestimate the dermal penetration of a chemical that has been in the same soil for a longer period of time, the data on freshly spiked soil are important because they can be used to predict the risk from newly contaminated soil. However, bioavailability

can be decreased more by aging in soil than when the soil is newly contaminated. Therefore, the effects of aging in soil on further reducing the dermal penetration of phenanthrene were investigated. Because soil type (sand, clay) and the percent of organic matter in soil are factors that will influence chemical sorption, their effects on dermal penetration were also examined. From the data generated by this study, it was possible to evaluate the impact of chemical aging on the health risk from phenanthrene exposure. Environmentally acceptable endpoints (EAEs) can then be established for phenanthrene that has been aged in soil. The EAE is the concentration of chemical in soil that will not adversely affect human health and the environment (Alexander, 1995).

2. MATERIALS AND METHODS

2.1 Chemicals

Phenanthrene (9,10-¹⁴C), in ethanol, with a specific activity of 12.8 mCi/mmol and a radiochemical purity of 99% was purchased from New England Nuclear (NEN) Life Science Products, Boston, MA. Prior to use, the radioisotope was diluted with U.S.I. pure ethyl alcohol, dehydrated U.S.P. (U.S. Industrial Chemicals Co., Division of National Distillers and Chemical Corp., NY).

2.2 Soils

Studies were performed on two different soils. Both are representative of soil types widely distributed in the United States. The Atsion soil consists of 90% sand, 8% silt, 2% clay, 4.4% organic matter; has a pH of 4.2; and was collected from the Cohansey sand formation near Chatsworth in south central New Jersey (USDA, 1977). The Keyport soil contains 50% sand, 28% silt, 22% clay, 1.6% organic matter; has a pH of 5.0; and was collected from the Woodbury formation near Moorestown in southwestern New Jersey (USDA, 1972). The majority of the soil particles were 50-250 μm in size. Soil analyses were performed by the Soil Testing Laboratory at Rutgers Cooperative Extension Resource Center, Rutgers University, New Brunswick, NJ. Organic matter content was measured by a modified Walkley and Black (1934) dichromate oxidation method.

2.3 Chemical Aging in Soil

Radiolabeled phenanthrene was added to each of the soils that had been previously autoclaved and hydrated to 11% (w/w) with sterile distilled-deionized water. This is the maximum amount of water that could be used to lightly moisten the soils without there being an excess of water when phenanthrene was added to the soils. Soil moisture content is an important factor in contaminant sorption (Unger et al., 1996) because water may compete with organic molecules for adsorption sites on soil (Ruiz et al., 1998). Phenanthrene was added to soil at a ratio of 100 μg to 1 g of soil. After phenanthrene was mixed thoroughly with the soils to ensure uniform distribution of chemical, spiked soils were added to Teflon-sealed vials and stored in the dark at room temperature for 3 months and 6 months.

2.4 Animal Model

Whole pig skin was obtained from the costo-abdominal areas of euthanized (40-60 lb) male Yorkshire pigs (Cook College Farm, Rutgers University, New Brunswick, NJ). The pig has been widely accepted as an animal model for studying human percutaneous absorption of a large variety of chemicals under various experimental conditions (Bartek et al., 1972; Reifenrath and Hawkins, 1986; Qiao et al., 1993) because of the well documented histological (Monteiro-Riviere and Stromberg, 1985), physiological, biochemical, and pharmacological similarities between pig skin and human skin

(Qiao and Riviere, 2000). Skin was transported to the laboratory and viability maintained in ice-cold HEPES buffered (25 mM) Hank's balanced salt solution (HHBSS), pH 7.4, containing gentamycin sulfate (50 mg/l) (Collier et al., 1989) after which it was immediately prepared for diffusion cells according to Bronaugh and Stewart (1985).

2.5 *In Vitro* Dermal Penetration Studies

Excised skin was cut to a thickness of 200 μm with a dermatome (Padgett Electro-Dermatome Model B, Padgett Instruments Inc., Kansas City, MO) and circular pieces were mounted into Teflon flow-through diffusion cells (Crown Bio Scientific, Inc., Somerville, NJ). The exposed skin surface area (0.64 cm^2) was maintained at a temperature of 32°C. The dermal side of each skin sample was perfused with HHBSS containing 10% fetal bovine serum (Sigma/Aldrich, St. Louis, MO) at a flow rate of 3 ml/h and aerated continuously with oxygen (Collier et al., 1989). Chemical was applied to the surface of the skin either alone in 5 μl of ethanol vehicle, immediately after the addition of 30 mg of soil, or after aging in 30 mg of each of the two soils. The chemical dose was 5.2 $\mu\text{g}/\text{cm}^2$ skin. Receptor fluid (perfusate) was collected in scintillation vials containing 10 ml of Formula-989 liquid scintillation cocktail (Packard Instruments Co., Inc., Meriden, CT) up to 24 h postdosing. Loosely adsorbed chemical was washed from the skin surface with soap and water (once with 1 ml of a 1% aqueous soap solution and twice with 1 ml of distilled-deionized water). Skin samples were completely solubilized in Solvable (Packard) for 8 h at 50°C to determine the quantity of the chemical remaining in skin. Radioactivity in all samples was counted by liquid scintillation spectrometry (LS 7500, Beckman Instruments, Inc., Fullerton, CA). Sample quench was corrected by using the H-ratio method.

2.6 Statistical Analysis

All data were reported as the mean \pm standard error of the mean (SEM) and expressed as percent of the initial dose. Statistical differences between treatment groups were determined by one-way analysis of variance (ANOVA) with Scheffe's test except for the soil comparisons which were performed by Student's independent t-test. The level of significance was $p < 0.05$.

3. RESULTS

A comparison between the dermal penetration of pure phenanthrene and phenanthrene in the Atsion soil (as freshly spiked or aged) is shown in Table 1. When soil was freshly spiked, the dermal penetration of phenanthrene was significantly decreased versus pure chemical. Four percent of the pure phenanthrene dose penetrated into the receptor fluid during the 24 h collection period. However, only one-half that amount was detected for phenanthrene in the freshly spiked Atsion soil. Lipophilic compounds have a tendency to form reservoirs in skin (Chu et al., 1996). Therefore, when dermal penetration studies are conducted, it is also necessary to determine the amount of chemical remaining in skin because chemical that forms a reservoir in skin has the potential to be absorbed systemically with time. In this study, most of the pure phenanthrene dose (61%) was detected in skin. Atsion soil freshly spiked with phenanthrene reduced the amount of phenanthrene in skin to 24% of the initial dose. The total penetration represents the sum of the chemical penetrating into the receptor fluid and the amount in skin (Chu et al., 1996). Because skin contained more radioactivity than receptor fluid, the percent of the initial phenanthrene dose comprising total penetration was very similar to that in skin (65% for pure and 26% for freshly spiked soil).

Table 1. Effect of Aging Time in Atsion Soil on the Dermal Penetration of Phenanthrene

| Pure | Freshly Spiked | Aged 3 Months | Aged 6 Months |
|------|----------------|---------------|---------------|
|------|----------------|---------------|---------------|

| | Pure | Freshly Spiked | Aged 3 Months | Aged 6 Months |
|-----------------|------------------------|-------------------------|----------------------------|----------------------------|
| Receptor Fluid | 4.2 ± 0.6 ^a | 2.1 ± 0.3 ^b | 0.38 ± 0.03 ^{b,c} | 0.26 ± 0.03 ^{b,c} |
| Skin | 61.2 ± 3.7 | 23.8 ± 1.5 ^b | 10.7 ± 1.6 ^{b,c} | 3.8 ± 0.5 ^{b,c} |
| Total Penetrat. | 65.4 ± 3.9 | 25.9 ± 1.4 ^b | 11.1 ± 1.7 ^{b,c} | 4.0 ± 0.6 ^{b,c} |
| Skin Wash | 5.9 ± 0.6 | 73.1 ± 1.1 ^b | 88.9 ± 1.7 ^{b,c} | 96.0 ± 0.6 ^{b,c} |

^a Mean ± SEM of percent initial dose for n = 10-11 replicates per treatment from 3 pigs

^b Significantly different from pure (p < 0.05, ANOVA)

^c Significantly different from freshly spiked (p < 0.05, ANOVA)

Further reductions in the dermal penetration of phenanthrene into receptor fluid and skin were observed after aging in Atsion soil. Only 0.4% and 0.3% of the initial dose, respectively, were detected in receptor fluid after 3 and 6 months aging. Likewise, radioactivity in skin was decreased to 11% and 4%, respectively. Consequently, total penetration was lowered to 11% of the initial dose after 3 months of aging and to 4% after 6 months. The skin wash data correlated well with the results for total penetration. Only 6% of the radioactivity applied to skin was found in the skin wash for the pure compound. As less phenanthrene penetrated skin, more radioactivity remained on skin (73-96%).

For freshly spiked Keyport soil, penetration into receptor fluid was reduced to about one-third of phenanthrene without soil (Table 2). Skin contained 16% of the dose while total penetration was 17%. Although the total penetration of phenanthrene aged for 3 months in Keyport soil (20%) was similar to that in the freshly spiked soil, results revealed a further decrease to 9% of the dose after 6 months of aging. An increase in the amount of radioactivity retained by soil was also evident in the skin wash with aging.

Table 2. Effect of Aging Time in Keyport Soil on the Dermal Penetration of Phenanthrene

| | Pure | Freshly Spiked | Aged 3 Months | Aged 6 Months |
|-----------------|------------------------|-------------------------|-------------------------|-------------------------|
| Receptor Fluid | 4.2 ± 0.6 ^a | 1.3 ± 0.2 ^b | 0.6 ± 0.1 ^b | 0.8 ± 0.2 ^b |
| Skin | 61.2 ± 3.7 | 16.0 ± 2.4 ^b | 19.9 ± 3.5 ^b | 8.2 ± 1.9 ^b |
| Total Penetrat. | 65.4 ± 3.9 | 17.4 ± 2.5 ^b | 20.5 ± 3.5 ^b | 9.1 ± 2.1 ^b |
| Skin Wash | 5.9 ± 0.6 | 81.5 ± 2.5 ^b | 79.5 ± 3.5 ^b | 90.9 ± 2.1 ^b |

^a Mean ± SEM of percent initial dose for n = 8-11 replicates per treatment from 3 pigs

^b Significantly different from pure (p < 0.05, ANOVA)

When the total penetration of phenanthrene was compared between the two soils (Table 3), it was found that the total dermal penetration of phenanthrene in freshly spiked Keyport soil (17%) was significantly lower than that in the Atsion soil (26%). However, the total dermal penetration of phenanthrene in the Atsion soil was about one-half that in the Keyport soil for both aging times.

Table 3. Effect of Soil Type on the Dermal Penetration of Phenanthrene

| Time in Soil | Atsion Soil | Keyport Soil |
|----------------|-------------------------|-------------------------|
| Freshly Spiked | 25.9 ± 1.4 ^a | 17.4 ± 2.5 ^b |
| 3 Months | 11.1 ± 1.7 | 20.5 ± 3.5 ^b |
| 6 Months | 4.0 ± 0.6 | 9.1 ± 2.1 ^b |

^a Percent total penetration (mean ± SEM) for n = 8-11 replicates per treatment from 3 pigs

^b Significantly different from the Atsion soil (p < 0.05, Student's independent t-test)

3.1 Discussion and Conclusions

Dermal exposure to pure phenanthrene is a potential health hazard because a reservoir of chemical was detected in skin. The formed reservoir may contribute to skin sensitization which may eventually cause skin rashes and blisters. However, a decrease in dermal penetration was observed when phenanthrene was sorbed to a soil matrix. The dermal penetration of phenanthrene was significantly decreased by 60% and 73%, respectively, in freshly contaminated Atsion and Keyport soils relative to pure chemical.

It is well established that soil organic matter acts primarily as a partition medium, while mineral matter acts as an adsorbent in the sorption of nonionic organic compounds in soil (Karickhoff et al.,

1979; Chiou and Shoup 1985; Gschwend and Wu 1985; Haderlein and Schwarzenbach 1993; Chiou et al., 2000). In this study, a lower total penetration of phenanthrene as well as a higher percentage of clay in the Keyport soil (11 times greater than Atsion soil) suggests that more surface adsorption occurred in that soil when it was freshly spiked.

After 3 months of aging, the dermal penetration of phenanthrene was reduced by 83% in the Atsion soil. However, for the Keyport soil, 3 months aging did not reduce penetration through skin more than the newly contaminated soil. Instead, a longer aging time was needed to decrease the dermal penetration of phenanthrene further in that soil. By extending the aging time to 6 months, lowered penetration through skin was reduced by 94% in the Atsion soil and by 86% in the Keyport soil. Also, the dermal penetration of phenanthrene was about 50% less when aged in the Atsion soil than in the Keyport soil. The Atsion soil contains three times as much organic matter as the Keyport soil which indicates that with time, more sequestration into organic matter occurred in that soil. Nam et al. (1998) suggested that the organic matter content of soil is a major determinant of sequestration. In their studies, sequestration was measured by the extent of mineralization of phenanthrene by an added bacterium. Furthermore, the data of Nam and Kim (2002) suggested that major sequestration sites for aged phenanthrene may reside in the humin-mineral fraction of soil.

Since the effects of phenanthrene on human health are dependent on the dermal bioavailability of the chemical, the data indicate that the potential health risks from dermal exposure to phenanthrene would be reduced by soil and aging compared to phenanthrene without soil. The data from this study can have an impact on the EAEs of phenanthrene. EAEs were calculated by dividing the total penetration of pure phenanthrene by the total penetration of phenanthrene aged in soil for 3 or 6 months. Three months aging in the Atsion soil raises the EAE for phenanthrene 6-fold compared to the chemical without soil. After aging for 6 months, the EAE for phenanthrene increases 18-fold. In the Keyport soil, the increase in the EAE for 3 months aged phenanthrene would be 3.4-fold compared to the pure chemical while 6 months aging in the same soil increases the EAE to 11.7-fold versus the chemical alone. With increased EAEs, less soil cleanup would be required at contaminated sites where phenanthrene aging has occurred. As a result, soil remediation costs would be lower and there would be fewer site restrictions.

REFERENCES

- Abdel-Rahman, M.S., Skowronski, G.A., and Turkall, R.M. 2002. Assessment of the dermal bioavailability of soil-aged benzo(a)pyrene. *Human Ecol. Risk Assess.* 8, 429-441.
- Abdel-Rahman, M.S., Skowronski, G.A., and Turkall, R.M. 2004. Dermal bioavailability of toluene aged in soil. *Soil and Sediment Contam.* 13, 17-24.
- Abdel-Rahman, M.S., Skowronski, G.A., and Turkall, R.M. 2005. In vitro penetration of pig skin by heavy metals in soil. *Soil and Sediment Contam.* 14, 123-134.
- Abdel-Rahman, M.S., Skowronski, G.A., and Turkall, R.M. 2006. Impact of aging time on the dermal penetration of phenol in soil. *Soil and Sediment Contam.* 15, 47-60.
- Alexander, M. 1995. How toxic are toxic chemicals in soil? *Environ. Sci. Technol.* 29, 2713-2717.
- Alexander, M. 2000. Aging, bioavailability, and overestimation of risk from environmental pollutants. *Environ. Sci. Technol.* 34, 4259-4265.
- Aochi, Y.O. and Farmer, W.J. 1997. Role of microstructural properties in the time-dependent sorption/desorption behavior of 1,2-dichloroethane on humic substances. *Environ. Sci. Technol.* 31, 2520-2526.
- ATSDR (Agency for Toxic Substances and Disease Registry). 1995. Toxicological Profile for Polycyclic Aromatic Hydrocarbons (PAHs), pp. 1-11, 235, 261. U.S. Department of Health and Human Services, Public Health Service, Atlanta, GA.
- ATSDR, 2006. HazDat (Hazardous Substances Database). U.S. Department of Health and Human Services, Public Health Service, Atlanta, GA.
- Bartek, M.J., LaBudde, J.A., and Maibach, H.I. 1972. Skin permeability in vivo: Comparison in rat, rabbit, pig, and man. *J. Invest. Dermatol.* 58, 114-123.
- Bowmer, K.H. 1991. Atrazine persistence and toxicity in two irrigated soils of Australia. *Austral. J. Soil Res.* 29, 339-350.
- Bronaugh, R.L. and Stewart, R.F. 1985. Methods for in vitro percutaneous absorption studies. IV. The flow-through diffusion cell. *J. Pharm. Sci.* 74, 64-67.
- Chiou, C.T. and Shoup, T.D. 1985. Soil sorption of organic vapors and effects of humidity on sorptive mechanism and capacity. *Environ. Sci. Technol.* 19, 1196-1200.

- Chiou, C.T., Kile, D.E., Rutherford, D.W. et al. 2000. Sorption of selected organic compounds from water to a peat soil and its humic-acid and humin fractions: potential sources of the sorption nonlinearity. *Environ. Sci. Technol.* 34, 1254-1258.
- Chu, I., Villeneuve, D.C., Cote, M. et al. 1988. Dermal toxicity of a medium-boiling (154-378°C) coal liquefaction product in the rat – Part 1, *J. Toxicol. Environ. Health*, 23, 193-206.
- Chu, I., Dick, D., Bronaugh, R. et al. 1996. Skin reservoir formation and bioavailability of dermally administered chemicals in hairless guinea pigs. *Fd. Chem. Toxicol.* 34, 267-276.
- Collier, S.W., Sheikh, N.M., Sakr, A. et al. 1989. Maintenance of skin viability during in vitro percutaneous absorption/metabolism studies. *Toxicol. Appl. Pharmacol.* 99, 522-533.
- Duffus, J.H. 1980. *Environmental Toxicology*, pp. 101-102, New York, John Wiley & Sons, Inc.
- Gschwend, P.M. and Wu, S.C. 1985. On the constancy of sediment-water partition coefficients of hydrophobic organic pollutants. *Environ. Sci. Technol.* 19, 90-96.
- Haderlein, S.B. and Schwarzenbach, R.P. 1993. Adsorption of substituted nitrobenzenes and nitrophenols to mineral surfaces. *Environ. Sci. Technol.* 27, 316-326.
- Harvey, R.G. 1991. *Polycyclic Aromatic Hydrocarbons, Chemistry and Carcinogenicity*. New York, Cambridge University Press.
- Hatzinger, P.B. and Alexander, M. 1995. Effect of aging of chemicals in soil on their biodegradability and extractability. *Environ. Sci. Technol.* 29, 537-545.
- IARC (International Agency for Research on Chemicals). 1983. Phenanthrene. *Monographs on the Evaluation of Carcinogenic Risk of Chemicals to Humans*. 32, 419-430.
- Ibbotson, B.G., Gorber, D.M., Reades, D.W. et al. 1989. A site-specific approach for the development of soil cleanup guidelines for trace organic chemicals. In: *Petroleum Contaminated Soils, Volume 1*, pp. 321-342. (Kostecki, P.T. and Calabrese, E.J., Eds.). Chelsea, Michigan, Lewis Publishers.
- Karickhoff, S.W., Brown, D.S., and Scott, T.A. 1979. Sorption of hydrophobic pollutants on natural sediments. *Water Res.* 13, 241-248.
- Karimi-Lotfabad, S., Pickard, M.A., and Gray, M.R. 1996. Reactions of polynuclear aromatic hydrocarbons on soil. *Environ. Sci. Technol.* 30, 1145-1151.
- Kelsey, J.W., Kottler, B.D., and Alexander, M. 1997. Selective chemical extractants to predict bioavailability of soil-aged organic chemicals. *Environ. Sci. Technol.* 31, 214-217.
- Laor, Y., Strom, P.F., and Farmer, W.J. 1999. Bioavailability of phenanthrene sorbed to mineral-associated humic acid. *Water Res.* 33, 1719-1729.
- Linz, D.G. and Nakles, D.V. 1997. Executive Summary. In: *Environmentally Acceptable Endpoints in Soil*, pp. 22-40. (Linz, D.G. and Nakles, D.V., Eds.). Annapolis, Maryland, American Academy of Environmental Engineers.
- Lock, K. and Janssen, C.R. 2003. Influence of aging on metal availability in soils. *Rev. Environ. Contam. Toxicol.* 178, 1-21.
- Loehr, R.C. and Webster, M.T. 1997. Effect of treatment on contaminant availability, mobility, and toxicity. In: *Environmentally Acceptable Endpoints in Soil*, pp. 137-386. (Linz, D.G. and Nakles, D.V., Eds.). Annapolis, Maryland, American Academy of Environmental Engineers.
- Monteiro-Riviere, N. and Stromberg, M. 1985. Ultrastructure of the integument of the domestic pig (*Sus scrofa*) from one through fourteen weeks of age. *Anat. Histol. Embryol.* 14: 97-115.
- Nam, K., Chung, N., and Alexander, M. 1998. Relationship between organic matter content of soil and the sequestration of phenanthrene. *Environ. Sci. Technol.* 32, 3785-3788.
- Nam, K. and Kim, J.Y. 2002. Role of loosely bound humic substances and humin in the bioavailability of phenanthrene aged in soil. *Environ. Pollut.* 118, 427-433.
- NEPI (National Environmental Policy Institute). 2000. *Assessing the Bioavailability of Organic Chemicals in Soil for Use in Human Health Risk Assessments*, Washington, DC.
- NJDHSS (New Jersey Department of Health and Senior Services). 1999. Hazardous Substance Fact Sheet: Phenanthrene.
- Pu, X., Lee, L.S., Galinsky, R.E. et al. 2004. Evaluation of a rat model versus a physiologically based extraction test for assessing phenanthrene bioavailability from soils. *Toxicol. Sci.*, 79, 10-17.
- Qiao, G., Chang, S., and Riviere, J. 1993. Effects of anatomical site and occlusion on the percutaneous absorption and residue pattern of 2,6-(ring-¹⁴C) parathion in vivo in pigs. *Toxicol. Appl. Pharmacol.* 122, 131-138.
- Qiao, G. and Riviere, J.E. 2000. Dermal absorption and tissue distribution of 3,3', 4,4'-tetrachlorobiphenyl (TCB) in an ex-vivo pig model: assessing the impact of dermal exposure variables. *Int. J. Occup. Environ. Health*, 6, 127-137.
- Reid, B.J., Jones, K.C., and Semple, K.T. 2000. Bioavailability of persistent organic pollutants in soils and sediments – a perspective on mechanisms, consequences, and assessment. *Environ. Pollut.* 108, 103-112.
- Reifenrath, W. and Hawkins, G. 1986. The weanling Yorkshire pig as an animal model for measuring percutaneous penetration. In: *Swine in Biomedical Research*, pp. 673-680. (Tumbelson, M.E., Ed.). New York, Plenum.
- Robertson, B.K. and Alexander, M. 1998. Sequestration of DDT and dieldrin in soil. Disappearance of acute toxicity but not the compounds. *Environ. Toxicol. Chem.* 17, 1034-1038.
- Roy, T.A. and Singh, R. 2001. Effect of soil loading and soil sequestration on dermal bioavailability of polynuclear aromatic hydrocarbons. *Bull. Environ. Contam. Toxicol.* 67, 324-331.
- Ruiz, J., Bilbao, R., and Murillo, M.B. 1998. Adsorption of different VOC's onto soil minerals from gas phase: Influence of mineral, type of VOC, and air humidity. *Environ. Sci. Technol.* 32, 1079-1084.

- Scribner, S.L., Benzing, T.R., Sun, S. et al. 1992. Desorption and bioavailability of aged simazine residues in soil from a continuous corn field. *J. Environ. Qual.* 21, 115-120.
- Steinberg, S.M., Pignatello, J.J., and Sawhney, B.L. 1987. Persistence of 1,2-dibromoethane in soils: Entrapment in intraparticle micropores. *Environ. Sci. Technol.* 21, 1201-1208.
- Tang, J., Robertson, B.K., and Alexander, M. 1999. Chemical-extraction methods to estimate bioavailability of DDT, DDE, and DDD in soil. *Environ. Sci. Technol.* 33, 4346-4351.
- Turpeinen, R., Virta, M., and Haggblom, M.M. 2003. Analysis of arsenic bioavailability in contaminated soils. *Environ. Toxicol. Chem.* 22, 1-6.
- Unger, D.R., Lam, T.T., Schaefer, C.E. et al. 1996. Predicting the effect of moisture on vapor-phase sorption of volatile organic compounds to soils. *Environ. Sci. Technol.* 30, 1081-1091.
- USDA (U.S. Department of Agriculture). 1972. National Cooperative Soil Survey: Official Series Description, Keyport Series, Soil Conservation Service, Washington, DC.
- USDA (U.S. Department of Agriculture). 1977. National Cooperative Soil Survey: Official Series Description, Atsion Series, Soil Conservation Service, Washington, DC.
- USEPA (United States Environmental Protection Agency). 1986. Test Methods for Evaluating Solid Wastes. Office of Solid Wastes, Washington, DC. SW-846.
- USEPA (United States Environmental Protection Agency). 1992. Framework for Ecological Risk Assessment. Risk Assessment Forum, Washington, DC. EPA/630/R92/001.
- Walkley, A. and Black, I.A. 1934. An examination of Degtjareff method for determining soil organic matter and a proposed modification of the chromic acid titration method. *Soil Sci.* 37, 29-37.
- Wilson, S.C. and Jones, K.C. 1993. Bioremediation of soil contaminated with polynuclear aromatic hydrocarbons (PAHs): A review. *Environ. Pollut.* 81, 229-249.
- Wyzga, R.E. and Goldstein, L.S. 1994. Assessing the carcinogenic potency of environmental coal tars, by-products of coal gasification. In: *Toxicology of Chemical Mixtures*, pp. 83-97. (Yang, R.S.H., Ed.). San Diego, CA, Academic Press.

Chapter 31

OVERVIEW OF PERFLUOROOCCTANOIC ACID

State of the Science

Brooke Moore, E.I.T.
ENSR Corporation

Abstract: The US Environmental Protection Agency (EPA) has been reviewing data and developing a draft risk assessment for Perfluorooctanoic Acid (PFOA). PFOA is a synthetic chemical, sometimes referred to as “C8”, used by chemical companies and manufacturers to make non-stick cookware, water repellent coatings for all-weather clothing and fabrics, food packing, gaskets, O-rings, and hoses. It is chiefly used in producing fluoropolymers which are employed in almost all commercial industry segments including aerospace, automotive, building/construction, chemical processing, electrical and electronics, semiconductor, and textile industries. The durability of PFOA due to its specific chemical structure prevents breakdown in the environment which leads to widespread persistence in the environment. It is this persistence which prompted the EPA to conduct a further evaluation of PFOA and its potential to adversely affect human health.

Key words: perfluorooctanoic acid, fluoropolymers

1. INTRODUCTION

Perfluorooctanoic Acid (PFOA) is a synthetic chemical discovered in the mid-20th century by a well established chemical company. The term PFOA is used to describe not only the carboxylic acid $C_8HF_{15}O_2$, but also a family of perfluorinated chemicals including perfluorooctanoic salts. PFOA is also sometimes referred to as “C8” which the amount of carbon chains found the molecule. Widespread interest in the health impacts of PFOA has been sparked due to recent media attention to this chemical and EPA scrutiny of PFOA. This paper was written to inform the reader about PFOA’s chemical composition, historical use and production, known toxicity, and actions taken by the EPA and state agencies regarding regulations.

2. SOURCES

PFOA is chiefly used by chemical companies and manufacturers to make fluoropolymers, which are utilized in the manufacture of non-stick cookware and breathable, stain resistant, all-weather clothing (US EPA, 2006). Given fluoropolymers’ unique nature to be both hydrophobic and lipophilic, products containing fluoropolymers are used in almost every major commercial industry from automotive to food packaging. While PFOA is used the production of these compounds, finished fluoropolymer products are not intended to contain PFOA. According to the Society of the Plastics Industry, Inc. (SPI), PFOA is largely removed, recycled, or destroyed during the final stages of fluoropolymer production by high-temperature processing when fluoropolymers are made into finished products (Society of Plastics Industry, 2005). Although, PFOA may not be part of an end-product; those fluoropolymers eventually thermally or biologically decompose to form daughter products including PFOA.

Between 1992 and 2002, the only major US manufacture of PFOA at the time averaged approximately 250,000 pounds per year in production. Less than 600 metric tons per year of PFOA

and its salts were manufactured in the US or imported in recent years (USEPA, 2002). Ninety-seven percent of the amount produced was distributed to industrial clientele or used in the companies' own fluoropolymer production. The remaining portion was used in medical film coating applications and circuit boards and precision bearings (Wendling, 2003).

3. EMISSIONS

PFOA emissions into air and surface water near plants have been heavily scrutinized by the EPA, causing companies to pay specific attention to point source emissions. According to company documents of the only current US manufacture of PFOA, approximately 85% of the PFOA produced by their facilities in 2003 was either recovered or destroyed. By 2004, the percentage recovered or destroyed had increased to 98% (DuPont, 2005).

In the late 1990's, EPA received information indicating that perfluorooctyl sulfonates (PFOS), a perfluorinated chemical similar in nature to PFOA, were widespread in the blood of the general population, and presented concerns for its persistence in the environment, potential for bioaccumulation, and general toxicity. Following discussions between the EPA and PFOS's manufacturer, the company terminated production of these chemicals. Findings on PFOS led the EPA to review similar compounds, including PFOA, starting in 2000, to determine whether they might present similar concerns (US EPA, 2006).

Given the EPA's scrutiny of PFOA, the only US major manufacturer at that time halted production in 2002 in search of alternative chemicals. Following the loss of their supplier, a major user of PFOA began producing the chemical, and has since been the only producer of PFOA in the US.

4. PFOA PROPERTIES

Most of the data and experiments associated with PFOA have been in aqueous solutions. Given the carboxylic structure of the atom, it is speculated that the most viable form in the environment would be the perfluorooctanoic ion. The high solubility (3400-9500 mg/l) and low vapor pressure (0.5-10 mmHg) help to bolster this claim. However, scientists agree that additional soil, sediment and air tests are need for confirmation (Santoro, 2003).

Due to the chemical structure of the molecule, PFOA is extremely stable in the environment. Multiple studies by private companies do not exhibit significant biodegradability of PFOA itself under normal environmental conditions (USEPA, 2002).

5. EXPOSURE PATHWAYS

The EPA was prompted to investigate PFOA due to concentrations found in a sampling of blood from blood banks. One study on blood serum samples collected in 2001 and 2002 showed perfluorinated chemicals (PFCs), including PFOA, are found in both genders and in similar concentrations for varying age groups. This suggests that PFOA does not bioaccumulate in the body. In addition, concentrations in the US are similar to those found in Japan, Canada, and in Europe. PFCs distribute predominately in the liver and blood plasma and their persistence is related more to a long half-life rather than bioaccumulation in fatty tissues, as with other chemicals (Calafat, 2006).

Exposure pathways for PFOA outside of the manufacturing facilities are not completely understood. Some scientists speculate that PFOA and related chemicals can be ingested, inhaled or possibly adsorbed through dermal contact (Begley).

In January 2005, the EPA completed its Draft Human Health Risk Assessment (HHRA) for PFOA. In the Draft HHRA, the EPA used a Margin of Exposure (MOE) to evaluate non-cancer endpoints. Significant findings included the following:

1. Epidemiological studies of mostly male workers in PFOA production facilities. –result: first study indicated a statistically significant association between prostate cancer mortality and employment duration, not confirmed by the second update study.
2. Serum cholesterol and triglyceride levels in the same workers were positively linked to PFOA exposures, (consistent with effects observed in a laboratory rats study) (SAB, 2005).
3. PFOA primarily distributes to the liver, serum, and kidneys, is not metabolized, with enterohepatic circulation.
4. Ammonium salt of PFOA does not appear to be a mutagenic.
5. Children, ages 2-12 years old, included in the blood serum study (n=598) had PFOA levels of 5.6 ppb, with some levels as high as 56.3 ppb. (SAB 2005).
6. Another study of PFOA half-life in humans indicated a half life of approximately 4.4 years.
7. A 13-week study performed on Rhesus monkeys: >30 mg/kg per day fatal, but clinical signs of toxicity at 3 mg/kg/day. Repeat doses showed primary target organ = liver; but symptoms from exposure to 300 parts per million (ppm) for 2 years included an increase in liver weight, hepatocellular hypertrophy, hematological effect, and testicular masses (SAB 2005). Studies reviewed by the EPA showed possible links between PFOA and developmental, liver, kidney, and reproductive issues in rats. Routes of exposure in the rodent subjects were observed through inhalation, ingestion, and dermal adsorption pathways.

Given the information reviewed, the EPA recommended PFOA be given a descriptor of *suggested* carcinogen (US EPA, 2006). The Draft HHRA was reviewed by the Scientific Advisory Board (SAB), which is customary for potential regulatory documents. Based on its review of the Draft HHRA, the SAB concluded that the current documentation more closely describes a *likely* carcinogen rather than a *suggested* carcinogen, suggesting the data shows PFOA as a “multi-site, multi-gender” carcinogen (SAB 2005). The SAB requested additional studies be conducted to provide additional information regarding the toxicity and potential carcinogenicity of PFOA. Additional studies on PFOA toxicology and pharmacokinetics are being conducted by the EPA, Center for Disease Control (CDC), and other government agencies and private companies.

As of the date of this paper, the EPA has not developed any cancer-based toxicity values. Nor has the EPA published screening levels for PFOA or related compounds for various media (soil, groundwater, etc.). Due to the presence of PFOA manufacturing and/or primary utilization facilities within their jurisdiction, several states have established screening levels. West Virginia Department of Environmental Protection (WVDEP) completed a C8 Assessment and Toxicity Team Report and established an inhalation and ingestion reference dose based on available toxicity data (CATT 2002). From there, WVDEP established screening levels for air (1 ug/m³), groundwater (150 ug/l), and soils (240 mg/kg). One other state environmental agency, the New Jersey Department of Environmental Protection (NJDEP), has established a generic screening level (NJDEP = 5 ug/l for ground/surface water) (GIST, 2003). However, the EPA has not endorsed these screening levels. Most of the observed concentrations in surface water and groundwater have been in the parts per trillion.

6. CURRENT STATUS

The EPA has signed Enforceable Consent Agreements (ECAs) with leading manufactures and users of PFOA to monitor emissions and media concentrations surrounding plants. In addition, the EPA, the only US manufacturer, the former US manufacturer, and six other leading users of PFOA have signed a Global Stewardship Program to reduce PFOA emissions by 95% by 2010, and eliminate the use of PFOA by 2015 (Johnson, 2006).

While questions still remain regarding the full toxicity, routes of exposure, and potential health effects for humans, the EPA is currently taking steps to remove PFOA from the manufacturing

process. In the upcoming year, additional information on the potential health effects associated with exposure to PFOA and its related compounds should be released by the EPA, the CDC, and private companies.

REFERENCES

- Begley, "Perfluoro chemicals: potential migration from food packaging." Oral Presentations from the 3rd International Symposium on Food Packaging.
- Calafat, Antonia, et. al. "Perfluorochemicals in Pooled Serum Samples from United States Residents in 2001 and 2002." *Environmental Science & Technology*, Vol. 40. No. 7, 2006. p.2128-2134.
- Final Ammonium Perfluorooctanoate (C8) Assessment of Toxicity Team (CATT) Report, August 2002.
- GIST, Ammonium Perfluorooctanoate (C-8) Groundwater Investigation Steering Team Report, August 2003.
- Johnson, Stephen. US EPA letter to Mr. Charles Holliday, DuPont. January 25, 2006. <http://www.epa.gov/opptintr/pfoa/pubs/pfoastewardship.htm>
- SAB. "Draft Risk Assessment of the Potential Human Health Effects Associated with Exposure to Perfluorooctanoic Acid and Its Salts" USEPA OPPT, Risk Assessment Division, January 2005.
- Santoro, Michael A., Letter to Document Control Office, Office of Pollution Prevention and Toxics, USEPA, August 1, 2003
- Society of the Plastics Industry, Inc. www.pfoa-facts.com 2005
- SEC Form 10-K Annual Report, E.I. DuPont De Nemours and Company 2005. http://library.corporate-ir.net/library/73/733/73320/items/189086/10K_2005.pdf
- US EPA, "Perfluorooctanoic Acid (PFOA) and Fluorinated Telomers – Basic Information on PFOA" www.epa.gov/oppt/pfoa/pfoainfo.htm March 2006
- US EPA, Revised Draft Hazard Assessment of Perfluorooctanoic Acid and Its Salts, Office of Pollution Prevention and Toxics, Risk Assessment Division, November 4, 2002.
- Wendling, Dr. Larry, Letter to Stephen L. Johnson, "Environmental, Health and Safety Measures Relating to Perfluorooctanoic Acid and its Salts (PFOA)" March 13, 2003

Chapter 32

THE DISTRIBUTION OF FISH ADVISORIES FOR MERCURY IN MASSACHUSETTS

Jane Rose, PhD

MassDEP, Office of Research and Standards, 1 Winter St., Boston, MA 02108, Tel: 617-574-6874, Email: jane.rose@state.ma.us; GIS Support: Alice Doyle, MassDEP GIS Program, 1 Winter St., Boston, MA 02108, Tel: 617-654-6624, Email: alice.doyle@state.ma.us

Abstract: Fish have been tested for mercury in Massachusetts since the 1980s. So far, 234 waterbodies have been tested, resulting in 97 fish advisories where fish had mercury levels above 0.5 mg/kg. Fish from 113 waterbodies did not contain elevated concentrations of mercury. When mapped, the distribution of fish advisories presents a picture of the history of mercury pollution in the state.

Key words: Watersheds; mercury; fish advisories; geographic distribution.

1. INTRODUCTION

Fish are a gauge of environmental contamination. They are at the top of the food chain in the aquatic environment, which is a catchment for air pollutants and pollutants in runoff and storm drainage. In the early 1980s, MassDEP began investigating contaminants in fish. By the 1990s, it became apparent that the main fish contaminants are mercury, PCBs and pesticides. Mercury contamination accounts for over 80% of the fish advisories issued by the Massachusetts Department of Public Health.

In the last seven years, Massachusetts has had a major initiative to reduce mercury uses and emissions, including stringent mercury controls for incinerators.

2. MATERIALS & METHODS

Waterbodies are selected for fish testing each year because of watershed analysis needs, research needs and public requests. Mercury analysis of fish samples is conducted at MassDEP's Wall Experiment Station. Fish advisories are issued by the Department of Public Health when mercury exceeds 0.5 mg/kg in fish tissue. As of 2005, 234 waterbodies have been tested, resulting in 97 fish advisories. Fish from 113 waterbodies did not contain elevated concentrations of mercury. About 40% of the waterbodies tested received an advisory.

Fish advisories were grouped by watershed. The percentage of mercury advisories in a watershed was determined by dividing the number of advisories for lakes in a watershed by the number of lakes tested in the watershed. This helps control the bias associated with some watersheds having more lakes tested than others. The percentage of mercury advisories in a watershed was mapped to graphically display the distribution of fish advisories for mercury.

Fish in some lakes were subsequently retested as part of a long-term lake monitoring research program.

3. RESULTS

The percentage of lakes tested with mercury advisories in a watershed is shown in Figure 1. The map shows the range of the percentage of advisories in each watershed. The watershed table (Table 1) shows the exact percentage of advisories in watersheds where three or more waterbodies have been tested.

Twenty-six lakes have been retested since emissions controls began, of which twenty-four had advisories for mercury. Tests in 11 lakes (~46%) showed that mean mercury levels had fallen below 0.5 mg/kg. The watersheds that were retested are shown in Table 2, along with the lowered percentage of lakes with fish mercury levels >0.5 mg/kg.

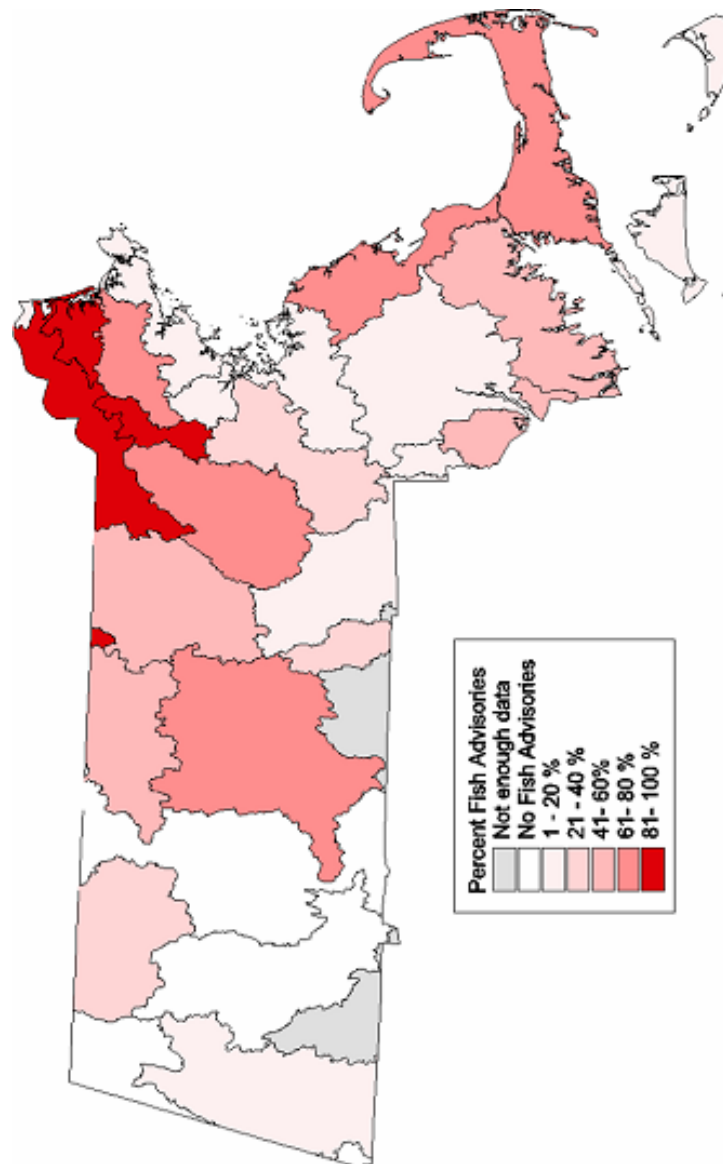

Figure 1. The Percentage of Mercury Advisories in Massachusetts Watersheds

Table 1. N=Number of waterbodies tested for fish mercury

| Watershed | N | % Advisories |
|------------|---|--------------|
| HUDSON | 7 | 0 |
| HOUSATONIC | 8 | 11 |
| DEERFIELD | 5 | 40 |

| Watershed | N | % Advisories |
|---------------|----|---------------|
| WESTFIELD | 7 | 0 |
| FARMINGTON | 2 | Too few tests |
| CONNECTICUT | 3 | 0 |
| MILLERS | 9 | 60 |
| CHICOPEE | 8 | 75 |
| QUINEBAUG | 2 | Too few tests |
| FRENCH | 5 | 40 |
| NASHUA | 17 | 59 |
| BLACKSTONE | 16 | 6 |
| MERRIMACK | 21 | 95 |
| SUASCO* | 13 | 77 |
| SHAWSHEEN | 6 | 83 |
| PARKER | 3 | 100 |
| IPSWICH | 9 | 67 |
| NORTH COASTAL | 5 | 20 |
| BOSTON HARBOR | 15 | 20 |
| CHARLES | 11 | 36 |
| SOUTH COASTAL | 6 | 67 |
| CAPE COD | 7 | 71 |
| ISLANDS | 15 | 20 |
| BUZZARDS BAY | 9 | 56 |
| TAUTON | 18 | 17 |
| NARRAGANSETT | 5 | 60 |
| TEN MILE | 5 | 20 |

Table 2. N=Number of retested waterbodies where mercury in fish was lowered to <0.5mg/kg.

| Watershed | N | % Reduction |
|---------------|---|-----------------|
| MERRIMACK | 7 | From 95% to 62% |
| BOSTON HARBOR | 1 | From 20% to 13% |
| SUASCO* | 1 | From 77% to 69% |
| CHICOPEE | 1 | From 75% to 63% |
| HOUSATONIC | 1 | From 11% to 0% |

* Sudbury, Assabet and Concord

4. DISCUSSION

The map of fish advisory distribution presents a historical picture of data collected from 1982 – 2005. It depicts peak fish mercury contamination in northeastern watersheds, where industrialization occurred in the 19th century, and four incinerators were operating in the 1980s and 1990s. The watersheds surrounding the area of peak fish contamination have the next highest percentage of fish advisories, along with south coastal watersheds, including Cape Cod, and the centrally located Chicopee watershed, which includes the Quabbin Reservoir. The western watersheds have relatively fewer fish advisories. The picture is one of fish mercury advisories corresponding to local, historic industrial sources, population density and urbanization.

Two of the incinerators (a municipal solid waste combustor and a medical waste facility) in northeast Massachusetts have closed. Emissions controls were integrated into the other two incinerators. Seven of the re-tested lakes in the vicinity of the incinerators have shown a decrease in mercury in fish (Table 2).

An interpretation of the pattern of fish advisories in the western part of the state could be that the hilly topography of Massachusetts prevents windborne mercury contamination from sources to our west from reaching our lakes. Wind patterns in Massachusetts are predominantly westerlies. Biester et al (2002) has shown that mountains, especially when forested, have higher net rates of mercury deposition than areas of lower elevation. The watersheds in western Massachusetts may be protected from airborne mercury contamination by a rainshadow-type effect from the Taconic Mountains to the west.

The fish advisory map is available online at the MassDEP website at <http://mass.gov/dep/toxics/stypes/hgres.htm>. The website also provides a list of all the waterbodies where fish have been tested, along with fish advisories that have been issued. The Massachusetts DPH website, <http://db.state.ma.us/dph/fishadvisory/>, provides more detailed information on fish advisories, including which species to avoid consuming in lakes with fish advisories.

5. CONCLUSIONS

Fish advisories are more prevalent in the watersheds of the northeast section of Massachusetts, where a long industrial history exists, and a concentration of major waste combustion sources operated in recent times. Controlling mercury emissions on a local scale has been accompanied by lowered levels of mercury in fish in about half of the re-tested lakes. Fewer lakes in the western part of Massachusetts have fish advisories compared to central and eastern Massachusetts lakes.

REFERENCE

H. Biester, G. Müller, H.F. Schöler. Estimating distribution and retention of mercury in three different soils contaminated by emissions from chlor-alkali plants: part I. *The Science of the Total Environment* 284 (2002) 177-189.

Chapter 33

ESTIMATION OF NATURAL RESOURCE DAMAGES FOR 23 FLORIDA CASES USING PHYSICAL FATES AND BIOLOGICAL MODELING

Jill Rowe, Deborah French McCay and Nicole Whittier
Applied Science Associates, Inc.

Abstract: Oil spill modeling was performed using the “type A” (simplified, with a minimum of field data requirements) modeling approach and SIMAP (Spill Impact Model Analysis Package) to assess marine biological injuries and natural resource damages (NRD) for 23 spill cases identified by Florida Department of Environmental Protection (DEP). The objectives were to provide (1) an assessment of the pathways and fate of the oil, and thus, estimate exposure to the water surface, shoreline and other habitats, water column, and sediments; and (2) estimates of injuries to wildlife, aquatic organisms, and habitats that were used to scale compensatory restoration. Compensatory habitat restoration for all quantifiable wildlife, fish and invertebrate injuries was scaled using Habitat Equivalency Analysis (HEA) and wetland habitat creation as mitigation. However, this is not a direct method of increasing sea turtle production. Therefore, scaling was performed to estimate the number of hatchlings needed to compensate for the sea turtle injuries. DEP then successfully submitted claims for NRD to the US Coast Guard Oil Pollution Fund.

Key words: natural resource damage assessment, NRDA, HEA, oil spill

1. INTRODUCTION

Florida Department of Environmental Protection (DEP) identified 23 oil spill cases to be analyzed for natural resource damages using the “type A” modeling approach. The 23 cases included mystery spills and other spills with uncompensated damages for which DEP was to submit claims to the US Coast Guard Oil Spill Liability Trust Fund.

Oil spill modeling was performed using the type A approach, which is a simplified procedure under the Comprehensive Environmental Response, Compensation and Liability Act of 1980 (CERCLA) for assessing injuries and damages, requiring a minimum of field work. It is designed for small spills, where it is not cost-effective for Trustees to perform extensive sampling in the field to assess injuries. Applied Science Associates (ASA) developed the type A Natural Resource Damage Assessment Model for Coastal and Marine Environments (NRDAM/CME) for the US Department of the Interior. The NRDAM/CME (Version 2.4, April 1996) was published as part of the CERCLA type A Natural Resource Damage Assessment (NRDA) Final Rule (Federal Register, May 7, 1996, Vol. 61, No. 89, p. 20559-20614). The technical documentation is French et al (1996a,b,c).

ASA has continued development of the model system as SIMAP (Spill Impact Model Analysis Package). The updates in SIMAP are summarized as follows:

1. updated and higher resolution habitat and depth mapping,
2. allows more detailed and time varying current data to be used,
3. simulation of subsurface releases (only surface releases are modeled in the NRDAM/CME),
4. updated physical fates algorithms,
5. higher resolution calculations,

6. use of updated oil toxicity data (French McCay, 2002),
7. potential to use site- and event-specific biological data,
8. calculation of biomass lost and production foregone for scaling compensatory restoration and restoration costs,
9. Windows 95+, 2000 or NT interface.

Given the updated methods and flexibility of SIMAP, SIMAP was used to evaluate injuries for the 23 spill cases. The cases were grouped by region of Florida: southeast (near Miami to Cape Canaveral), northeast (near Jacksonville), and southwest (Tampa Bay and surrounding). The specifications of each spill scenario are summarized in Table 1. Damages were based on restoration costs for habitat restoration in compensation for the injuries (using fish and wildlife production per unit of habitat restored and habitat equivalency analysis).

Table 1. Summary of 23 DEP cases and model inputs

| ASA # | Location | Date and Time | Oil Type | Volume | Release Depth |
|-----------------|---|----------------------------|----------------|----------------|---------------|
| SE CASES | | | | | |
| 7 | Miami River | Feb 23, 1999 3:41am | Diesel | 200 gallons | surface |
| 8 | Miami Beach | July 16, 1999 5:18 pm | Heavy fuel oil | 352 gallons* | surface |
| 9 | Miami River | May 9, 1996 9:00 am | Diesel | 200 gallons | surface |
| 10 | Key Largo - Ft. Pierce | April 23, 1995 7:00 pm | Heavy fuel oil | 6,895 gallons* | surface |
| 11 | John Lloyd State Park – St Lucie Inlet | May 5, 1994 5:30 am | Heavy fuel oil | 1,821 gallons* | surface |
| 12 | John Lloyd State Park – St Lucie Inlet | Sept. 13, 1993 10:00 pm | Heavy fuel oil | 241 gallons* | surface |
| 13 | Ft. Lauderdale canal | Feb. 26, 1999 6:42 pm | Diesel | 800 gallons* | surface |
| 14 | Ft. Lauderdale ICW | Feb. 6, 1999 8:00 am | Diesel | 300 gallons | surface |
| 15 | Port Everglades | Mar. 20, 1997 10:00 am | Lube oil | 512 gallons* | surface |
| 16 | Lantana, near Pt Everglades | Nov. 24, 1992 10:00 am | Diesel | 200 gallons | surface |
| NE CASES | | | | | |
| 17 | Cape Canaveral National Seashore | Dec. 17, 1992 7:25 pm | Diesel | 1,200 gallons | surface |
| 18 | Port Canaveral | Mar. 19, 1994 6:00 pm | Lube oil | 437.5 gallons* | surface |
| 19 | Port Canaveral | Aug. 4, 1995 4:00 am | Diesel | 1,000 gallons | 9.1 – 10.1 m |
| 20 | St. John's River | Nov. 9, 1994 7:30 am | Lube oil | 350 gallons* | surface |
| 21 | St. John's River | Nov. 17, 1994 12:00 pm | Lube oil | 300 gallons* | surface |
| 22 | St. John's River | June 13, 1996 2:00 am | Diesel | 2,000 gallons* | surface |
| 23 | St. John's River | Jan. 9, 1995 6:30 am | Diesel | 150 gallons | surface |
| SW CASES | | | | | |
| 1_2 | Anclote River | Mar. 13, 1993 7:00 am | Diesel | 7,100 gallons | 0 - 1 m |
| 3 | Caladesi Island State Park | Jan. 28, 1996 2:40 am | Diesel | 600 gallons* | 8.1 - 9.1 m |
| 4 | Holland America Terminal, East Bay | Sep. 27, 1995 7:00 pm | Heavy fuel oil | 5,000 gallons | surface |
| 5 | Whitaker bayou, Sarasota | Aug. 6, 1995 11:45 pm | Diesel | 450 gallons* | 0 - 1 m |

| ASA # | Location | Date and Time | Oil Type | Volume | Release Depth |
|-------|-----------------|--------------------------|----------|--------------|---------------|
| 6 | Ft. Myers Beach | Dec. 30, 1995 9:00 pm | Diesel | 460 gallons* | surface |

* Spill volume corrected for amount evaporated before the spill size estimate was made based on observations of oil in the water.

In order to analyze each case, several databases were developed with specific mapping and data for the location and event:

- Habitat mapping and gridding for model use.
- Depth data gridded for model use.
- Current data: tidal and river flow, as applicable to the location.
- Wind data for the two weeks after the event (hourly wind speed and direction).
- Biological abundance by species. For the estuarine and marine locations involved in the 23 cases, the needed data are available from the NRDAM/CME (French et al, 1996c).
- A restoration cost database. The habitat, fish, invertebrate, and wildlife injuries were translated to equivalent habitat areas needed for compensatory restoration. A simplified trophic level (food chain) model was used, as has been used for restoration scaling in OPA NRDA cases such as the *North Cape* (French et al., 2001). The compensatory habitats were seagrass or wetland (e.g., mangrove), as appropriate to the injuries in that case. Restoration costs per area of habitat in Florida were used. The damage claim was based on total compensatory restoration cost.

2. MATERIALS AND METHODS

2.1 Model Description

SIMAP contains physical fate and biological effects models, which estimate exposure and impact on each habitat and species (or species group) in the area of the spill. The physical fate model uses wind data, current data, and transport and weathering algorithms to calculate the mass of oil components in various environmental compartments (water surface, shoreline, water column, atmosphere, sediments, etc.), oil pathway over time (trajectory), surface oil distribution, and concentrations of the oil components in water and sediments. The biological effects model simulates movements of organisms, their exposure to oil, acute toxic effects of that exposure, and population-level impacts of the lost individuals. A hydrodynamic model is used to calculate currents that transport oil components and organisms. A tactical response model allows the user to simulate booming, mechanical cleanup, burning, and dispersant usage. Environmental, geographical, physical-chemical, and biological databases supply required information to the model for computation of fates and effects. SIMAP has been validated with more than 20 case histories, including the *Exxon Valdez* and other large spills (French McCay, 2003, 2004; French McCay and Rowe, 2004), as well as test spills designed to verify the model's transport algorithms (French et al., 1997).

SIMAP was derived from the physical fates and biological effects submodels in the Natural Resource Damage Assessment Model for Coastal and Marine Environments (NRDAM/CME), which were developed for the US Department of the Interior (USDOI) as the basis of Comprehensive Environmental Response, Compensation and Liability Act of 1980 (CERCLA) NRDA regulations for Type A assessments (French et al., 1996a,b,c). The technical documentation for the model is in French McCay (2003, 2004).

2.2 Natural Resource Damages Based on Habitat Restoration Costs

Under the US Oil Pollution Act of 1990 NRDA regulations published in January of 1996 by the US Department of Commerce (National Oceanic and Atmospheric Administration, NOAA), the

approach to NRDA has to use compensatory restoration costs rather than the older approach using economic valuation. In the modeling herein, the scaling of compensatory restoration employs methods currently practiced by NOAA and other trustees, i.e., Habitat Equivalency Analysis (HEA). The scaling methods were initially developed for use in the *North Cape* case, as described in French McCay and Rowe (2003).

Restoration should provide equivalent quality fish, invertebrate and wildlife biomass to compensate for the lost production (i.e., due to the injury caused by the spill). Equivalent quality implies same or similar species with equivalent ecological role and value for human uses. The equivalent production or replacement should be discounted to present-day values to account for the interim loss between the time of the injury and the time when restoration provides equivalent ecological and human services.

Habitat creation or preservation projects have been used to compensate for injuries of wildlife, fish and invertebrates. The concept is that the restored habitat leads to a net gain in wildlife, fish and invertebrate production over and above that produced by the location before the restoration. The size of the habitat (acreage) is scaled to just compensate for the injury (interim loss).

In the model, the habitat may be seagrass bed, saltmarsh, oyster reef, freshwater or brackish wetland, or other structural habitats that provide such ecological services as food, shelter, and nursery habitat and are more productive than open bottom habitats. The injuries are scaled to the new primary (plant) or secondary (e.g., benthic) production produced by the created habitat, as the entire food web benefits from this production. A preservation project that would avoid the loss of habitat could also be scaled to the production preserved. The latter method would only be of net gain if the habitat is otherwise destined to be destroyed.

The approach to scaling the size of the needed project is to use primary production to measure the benefits of the restoration. The total injuries in kg are translated into equivalent plant (angiosperm) production as follows. Plant biomass passes primarily through the detrital food web via detritivores consuming the plant material and attached microbial communities. When macrophytes are consumed by detritivores, the ecological efficiency is low because of the high percentage of structural material produced by the plant, which must be broken down by microorganisms before it can be used by the detritivore. Each species group is assigned a trophic level relative to that of the detritivores. If the species group is at the same trophic level as detritivores, it is assumed 100% equivalent, as the resource injured would presumably have the same ecological value in the food web as the detritivores. If the injured resource preys on detritivores or that trophic level occupied by the detritivores, the ecological efficiency is that for trophic transfer from the prey to the predator. Values for production of predator per unit production of prey (i.e., ecological efficiency) are taken from the ecological literature, as reviewed by French McCay and Rowe (2003).

The equivalent compensatory amount of angiosperm (plant) biomass of the restored resource is calculated as kg of injury divided by ecological efficiency. The ecological efficiency is the product of the efficiency of transfer from angiosperm to invertebrate detritivore and efficiency from detritivore to the injured resource, accounting for each step up the food chain from detritivore to the trophic level of concern. Table 2 lists the composite ecological efficiency relative to benthic invertebrate production for each trophic group in the model.

Table 2. Composite ecological efficiency relative to benthic invertebrate production by trophic group

| Species Category | Trophic Level | Ecological Efficiency Relative to Benthic Detritivores (%) |
|---------------------------------------|------------------------|--|
| <i>Fish and invertebrates</i> | | |
| Small pelagic fish | planktivorous | 20 |
| Large pelagic fish | Piscivores/predators | 0.8 |
| Demersal fish | bottom feeders | 10 |
| Mollusks | filter/bottom feeder | 20 |
| Benthic invertebrates (non-molluscan) | filter/bottom feeder | 20 |
| Demersal macroinvertebrate predators | predate bottom feeders | 4 |
| <i>Birds:</i> | | |

| Species Category | Trophic Level | Ecological Efficiency Relative to Benthic Detritivores (%) |
|------------------|----------------|--|
| Waterfowl | bottom feeders | 2 |
| Seabirds | piscivores | 0.4 |
| Waders | piscivores | 0.4 |
| Shorebirds | bottom feeders | 2 |
| Raptors | piscivores | 0.4 |

The productivity gained by the created habitat is corrected for less than full functionality during recovery using a sigmoidal recovery curve. Discounting at 3% per year is included for delays in production because of development of the habitat, and delays between the time of the injury and when the production is realized in the restored habitat. The equations and assumptions may be found in French McCay and Rowe (2003).

The needed data for the scaling calculations are:

- number of years for development of full function in the restored habitat;
- annual primary production rate per unit area (P) of restored habitat at full function (which may be less than that of natural habitats);
- delay before restoration project begins; and
- project lifetime (years the restored habitat will provide services).

In most locations, it is likely that saltmarsh restoration would be undertaken as restoration for wildlife, fish and invertebrate injuries. Seagrass (eelgrass) bed restoration is also an option. However, this requires good water quality and appropriate environmental conditions to be successful. The calculations of NRDA costs made here are based on (saltmarsh) wetland restoration for the northeast and southwest regions, as wetland is the more dominant habitat in those areas. In the southeast region, costs were based on mangrove restoration, as mangrove is the dominant habitat in the area.

HEA calculations for saltmarsh were performed following the methods in French McCay and Rowe (2003), as summarized above. The calculations are based on estimated aboveground primary production rates in saltmarshes. It is assumed that the created saltmarsh requires 15 years to reach 99% of full function (based on PERL, 1990; Zedler, 1992; Seneca and Broome, 1992; French et al., 1996a,b,c), ultimately reaching 80% of natural habitat productivity, the restoration begins 3 years after the spill, and the project lifetime is 50 years. For the injured resources, all weights are as wet weight and dry weight is assumed 22% of wet weight. For birds, the body mass per animal (from French et al., 1996a,b,c) is used to estimate injury in kg (multiplying by number killed and summing each species category).

The HEA approach assumes that sea turtles would be compensated by wetland creation. However, this is not a direct method of increasing sea turtle production. As sea turtle populations are thought to be limited by the production of hatchlings, a direct method of increasing hatchling survivorship would be more reliable and cost-effective compensation. Thus, scaling was also performed to estimate the number of hatchlings needed to compensate for the sea turtle injuries.

2.3 Model Inputs

For geographical reference, SIMAP uses a rectilinear grid to designate the location of the shoreline, the water depth (bathymetry), and the shore or habitat type. The grid is generated from a digital coastline using the ESRI Arc/Info compatible Spatial Analyst program. The cells are then coded for depth and habitat type. The digital shoreline, shore type, and habitat mapping were obtained from the Florida Environmental Sensitivity Index (ESI) Atlas database compiled for the state of Florida by Research Planning, Inc. (RPI).

The model uses hourly wind speed and direction for the time of the spill and simulation. In some cases, wind data for the time of the spill were available in the DEP case file. For others, standard meteorological data were acquired from the National Data Buoy Center Internet site for the nearest

NDBC buoy or from a nearby airport. Hourly mean wind speed and direction for the two weeks following the spill were compiled in the SIMAP model input file format.

Surface water temperature during the spill was provided by Florida DEP case reports. Salinity was assumed to be the mean value for the location of the spill site, based on data compiled in French et al. (1996b). Suspended sediment was assumed 10mg/l, a typical value for coastal waters (Kullenberg, 1982). The sedimentation rate was set at 1 m/day. The horizontal diffusion (randomized mixing) coefficient was assumed as 1 m²/sec, and the vertical diffusion (randomized mixing) coefficient was assumed 0.0001 m²/sec. These are reasonable values for coastal waters based on empirical data (Okubo and Ozmidov, 1970; Okubo, 1971) and modeling experience.

Currents have significant influence on the trajectory, and are critical data inputs. Tidal and wind-driven currents were included in the modeling analysis. Current data were either entered based on observational data of typical velocities or generated using ASA's boundary fitted coordinate hydrodynamic model (BFHYDRO). The governing equations and validation for BFHYDRO are described in detail in Muin and Spaulding (1997a, b) and Spaulding et al. (1999).

Physical and chemical data on the oils were taken from the NRDAM/CME database (French et al., 1996b), except for the PAH concentrations, which were based on data in French McCay (2001), the MAH concentrations, which were from Jokuty et al. (1996) or Wang et al. (1995), and the volatile aliphatic concentrations, which were calculated from boiling curves (in Whitticar et al., 1992; Jokuty et al. 1996), subtracting the volatile aromatics.

The NRDAM/CME (French et al., 1996c) contains mean seasonal or monthly abundances for 77 biological provinces in US coastal and marine waters. The biological data for wildlife, fish, invertebrates and lower trophic levels in the province where each of the 23 spills occurred was used for the SIMAP simulations of the spills. For all cases involving the outer coast, these data were also updated for sea turtles.

Sea turtle abundance was based on the methodology and assumptions outlined in a report on the August 2000 Florida Mystery Spill (French McCay et al., 2001). For adults, the sea turtle abundance data in French et al. (1996c) were assumed. French et al. (1996c) did not include abundance data for juveniles or hatchlings. Thus, estimates were developed based on strandings and nesting density on shore. For cases in the southeast region involving the outer coast, hatchling abundances were estimated based on nest density per km of shoreline. In the southeast region, in addition to hatchling abundance in the water, eggs and hatchlings would be impacted on oiled beaches where nests are present. Numbers of nests per length of beach were estimated from nest count data during the time around each spill date. Sea turtle nesting occurs primarily on the outer coast beaches. Thus, nest abundance on beaches was only estimated for those cases oiling the outer coast.

3. RESULTS

The injuries for the 23 DEP cases are summarized in Table 3.

Table 3. Summary of injuries for the 23 cases. Sea turtle injuries are totals for in water and on beaches.

| Region | ASA # | Wetlands and Mudflats Oiled (m ²) | Birds Killed (#) | Sea Turtles Killed (#) | Biomass of Fish and Invertebrates Lost (kg) |
|--------------------------|-------|---|------------------|------------------------|---|
| SE | 7 | 0 | 0.11 | 0 | 0 |
| SE | 8 | 0 | 0.91 | 527 | 0 |
| SE | 9 | 0 | 0.62 | 0 | 0 |
| SE | 10 | 259 | 14.6 | 1,440 | 0 |
| SE | 11 | 259 | 81 | 4,262 | 0 |
| SE | 12 | 775 | 1.7 | 951 | 0 |
| SE | 13 | 0 | 0.63 | 0 | 0 |
| SE | 14 | 0 | 0.15 | 0 | 0 |
| SE | 15 | 0 | 1.15 | 0.4 | 0 |
| SE | 16 | 0 | 0.05 | 0 | 0 |
| SE Regional total | | | 1,293 | 101 | 7,180 |
| NE | 17 | 0 | 0 | 0 | 277 |

| Region | ASA # | Wetlands and Mudflats Oiled (m ²) | Birds Killed (#) | Sea Turtles Killed (#) | Biomass of Fish and Invertebrates Lost (kg) |
|--------------------------|-------|---|------------------|------------------------|---|
| NE | 18 | 0 | 32.82 | 0 | 0 |
| NE | 19 | 0 | 0.18 | 0 | 40.1 |
| NE | 20 | 0 | 0.56 | 0 | 0 |
| NE | 21 | 28 | 0 | 0 | 0 |
| NE | 22 | 157 | 2.2 | 0 | 0 |
| NE | 23 | 65 | 0.04 | 0 | 0 |
| NE Regional total | | | 250 | 36 | 0 |
| SW | 1 2 | 301,602 | 109 | 0 | 12,793 |
| SW | 3 | 0 | 0.55 | 0 | 39.02 |
| SW | 4 | 170,473 | 75 | 0 | 5.83 |
| SW | 5 | 0 | 125.59 | 0 | 1,036 |
| SW | 6 | 147 | 18.1 | 0 | 0 |
| SW Regional total | | | 472,222 | 328 | 0 |

There were four cases in the southeast region that were mystery spills, presumably occurring offshore and where oil came ashore on the ocean-facing beaches. These releases were likely discharged from ships traveling in or just west of the western portion of the Gulf Stream. The oil is simulated as sweeping an area between the Gulf Stream and the shore, where the oil accumulated on the beaches. The other southeast cases were spills in the Intercoastal Waterway and associated canals. These were small spills, where only small areas of the water surface were oiled.

For cases in the southeast region, bird injuries range from less than 1 bird (a probability) to 81 birds. There were sea turtle injuries estimated for the four mystery spill cases on the outer coast, ranging from 527 to 4,262 turtles oiled. The turtle injuries were almost entirely for hatchlings. No injuries to marine mammals (cetaceans or manatees) were predicted by the model or observed. Fish and invertebrate injuries were negligible (zero) in all the southeast cases. This is because of the small volumes and/or large dilution volumes (offshore cases), as well as fast weathering in the heat of Florida.

In the northeast region, only one spill case examined was on the outer coast (a ship wreck on the beach in heavy surf), and it occurred in winter when sea turtles would not be present. Most of the spills were relatively contained in ports or were of small volume. Thus, the extent of surface oiling was limited in most cases. Subsurface contamination was dispersed rapidly such that impacts to water column organisms were limited.

For cases in the northeast region, bird injuries range from less than 1 bird (a probability) to 15 birds. No injuries to sea turtle or marine mammals (cetaceans or manatees) were predicted by the model or observed. Fish and invertebrate injuries were negligible (zero) for all but 2 cases in the northeast. Again, this is because of the small volumes and/or large dilution volumes (offshore cases), as well as fast weathering in Florida.

In the southwest region, one spill case was on the outer coast (a ship wreck in a storm) and the rest were in bays and coastal inlets. The ship wreck resulted in only small impacts to birds, fish and invertebrates. The two cases in the Anclote River resulted in significant oiling of the entire lower river, thus incurring significant impacts on wetlands, birds, fish and invertebrates. A spill in Sarasota Bay also impacted birds, fish and invertebrates to a significant extent. For the other cases, the oiling and impacts were more localized. No injuries to sea turtles or marine mammals (cetaceans or manatees) were predicted by the model or observed.

The injuries (Table 3) may be compensated by various restoration options, three of which were scaled:

- The acute mortality injuries to birds, sea turtles, fish and invertebrates may be restored by wetland restoration (Table 4). For the northeast and southwest regions, saltmarsh is the dominant wetland in the areas impacted, and the scaling is based on this wetland type. In the southeast, mangrove habitat is dominant, but often saltmarsh is restored as a first step, and the mangroves naturally colonize after the wetland is created. Thus, the areas required

are scaled as areas of mangrove habitat, the ultimate habitat, but likely saltmarsh plants would be planted over those areas.

- Sea turtle acute mortality is more directly and reliably restored by a direct restoration project for hatchling turtles (Table 5, showing injury as equivalent number of hatchlings), in which case their compensation would be subtracted from the total wetland compensation in Table 4.
- Injury to fauna in intertidal wetlands and mudflats, compensated by saltmarsh restoration in the northeast and southwest regions, and mangrove (likely via saltmarsh planting) restoration in the southeast (Table 6). These are in addition to the bird, sea turtle, fish and invertebrate mortality injuries compensated by the wetland restoration in Table 4.

Table 4. Summary of compensatory restoration requirements for acute mortality to birds, sea turtles, fish and invertebrates in the 23 cases if wetland (mangrove for SE, and saltmarsh for NE and SW) is created

| Region | ASA # | Birds (m ²) | Sea Turtles (m ²) | Fish and Invertebrates (m ²) | Total (m ²) |
|--------------------------|-------|-------------------------|-------------------------------|--|-------------------------|
| SE | 7 | 13 | 0 | 0 | 13 |
| SE | 8 | 186 | 6 | 0 | 192 |
| SE | 9 | 92 | 0 | 0 | 92 |
| SE | 10 | 751 | 19 | 0 | 770 |
| SE | 11 | 4,257 | 72 | 0 | 4,329 |
| SE | 12 | 372 | 14 | 0 | 386 |
| SE | 13 | 11 | 0 | 0 | 11 |
| SE | 14 | 8 | 0 | 0 | 8 |
| SE | 15 | 82 | 0 | 0 | 82 |
| SE | 16 | 8 | 0 | 0 | 8 |
| SE Regional total | | 5,779 | 110 | 0 | 5,890 |
| NE | 17 | 0 | 0 | 316 | 316 |
| NE | 18 | 410 | 0 | 0 | 410 |
| NE | 19 | 4 | 0 | 27 | 31 |
| NE | 20 | 12 | 0 | 0 | 12 |
| NE | 21 | 0 | 0 | 0 | 0 |
| NE | 22 | 45 | 0 | 0 | 45 |
| NE | 23 | 0.3 | 0 | 0 | 0.3 |
| NE Regional total | | 473 | 0 | 342 | 815 |
| SW | 1_2 | 2,686 | 0 | 5,007 | 7,694 |
| SW | 3 | 3 | 0 | 14 | 17 |
| SW | 4 | 1,935 | 0 | 2 | 1,937 |
| SW | 5 | 2,994 | 0 | 385 | 3,383 |
| SW | 6 | 429 | 0 | 0 | 429 |
| SW Regional total | | 8,048 | 0 | 5,408 | 13,460 |

Table 5. Summary of sea turtle compensatory restoration requirements (as equivalent number of hatchlings) for injuries to each life stage in both water and on beaches

| Region | ASA # | Hatchlings (#) | Juveniles (#) | Adults (#) | Total Equiv. # of Hatchlings |
|--------------------------|-------|----------------|---------------|------------|------------------------------|
| SE | 7 | 0.0 | 0.0 | 0.0 | 0.0 |
| SE | 8 | 527 | 5.9 | 84.7 | 618 |
| SE | 9 | 0.0 | 0.0 | 0.0 | 0.0 |
| SE | 10 | 1,440 | 17.6 | 198 | 1,655 |
| SE | 11 | 4,262 | 94.5 | 1,130 | 5,486 |
| SE | 12 | 951 | 13.9 | 169 | 1,134 |
| SE | 13 | 0.0 | 0.0 | 0.0 | 0.0 |
| SE | 14 | 0.0 | 0.0 | 0.0 | 0.0 |
| SE | 15 | 0.4 | 0.0 | 0.0 | 0.4 |
| SE | 16 | 0.0 | 0.0 | 0.0 | 0.0 |
| SE Regional total | | 7,180 | 132 | 1,582 | 8,894 |
| NE | 17 | 0.0 | 0.0 | 0.0 | 0.0 |
| NE | 18 | 0.0 | 0.0 | 0.0 | 0.0 |
| NE | 19 | 0.0 | 0.0 | 0.0 | 0.0 |

| Region | ASA # | Hatchlings (#) | Juveniles (#) | Adults (#) | Total Equiv. # of Hatchlings |
|--------------------------|-------|----------------|---------------|------------|------------------------------|
| NE | 20 | 0.0 | 0.0 | 0.0 | 0.0 |
| NE | 21 | 0.0 | 0.0 | 0.0 | 0.0 |
| NE | 22 | 0.0 | 0.0 | 0.0 | 0.0 |
| NE | 23 | 0.0 | 0.0 | 0.0 | 0.0 |
| NE Regional total | | 0 | 0 | 0 | 0 |
| SW | 1 2 | 0.0 | 0.0 | 0.0 | 0.0 |
| SW | 3 | 0.0 | 0.0 | 0.0 | 0.0 |
| SW | 4 | 0.0 | 0.0 | 0.0 | 0.0 |
| SW | 5 | 0.0 | 0.0 | 0.0 | 0.0 |
| SW | 6 | 0.0 | 0.0 | 0.0 | 0.0 |
| SW Regional total | | 0 | 0 | 0 | 0 |

Table 6. Wetland compensatory restoration requirements for faunal injuries in intertidal wetlands and mudflats (mangrove for SE, and saltmarsh for NE and SW).

| Region | ASA # | Wetland and Mudflat Injury (m ² -years) | Compensatory Wetland Area (m ²) |
|--------------------------|-------|--|---|
| SE | 7 | - | - |
| SE | 8 | - | - |
| SE | 9 | - | - |
| SE | 10 | 259 | 19 |
| SE | 11 | - | - |
| SE | 12 | 259 | 20 |
| SE | 13 | 775 | 61 |
| SE | 14 | - | - |
| SE | 15 | - | - |
| SE | 16 | - | - |
| SE Regional total | | 1,293 | 100 |
| NE | 17 | 0 | - |
| NE | 18 | 0 | - |
| NE | 19 | 0 | - |
| NE | 20 | 0 | - |
| NE | 21 | 28 | 4 |
| NE | 22 | 157 | 23 |
| NE | 23 | 65 | 10 |
| NE Regional total | | 250 | 37 |
| SW | 1 2 | 301,602 | 47,823 |
| SW | 3 | 0 | - |
| SW | 4 | 170,473 | 25,479 |
| SW | 5 | 0 | - |
| SW | 6 | 147 | 22.0 |
| SW Regional total | | 472,222 | 73,324 |

4. DISCUSSION AND CONCLUSIONS

The accuracy of the biological injury assessment depends primarily on the accuracy of (1) the fates model results, (2) the assumed toxicity values for fish and invertebrates, and (3) the biological abundance data input to the model. With more accurate current data, the fates model and percent mortality results would be more accurate, but the percent losses would change by less than an order of magnitude. The fish and invertebrate injury was quantified using toxicity assumptions for species of average sensitivity. While species and life stages vary considerably in their sensitivity to aromatics in oil, the exposures in the water column were so low in the southeast cases examined that injuries would not be expected for any species. The wildlife (bird and turtle) losses are directly proportional

to the pre-spill abundance assumed in the model inputs. Thus, a change (or uncertainty) in abundance is directly translated to a proportional change (uncertainty) in the quantified injury.

The goal of DEP for this project was to compile claims for 23 of their spills with uncompensated damages to be submitted to the US Coast Guard Oil Spill Liability Trust Fund (OSLTF). The uses of this fund, as delineated by the Oil Pollution Act (OPA), include: 1) removal costs incurred by the Coast Guard and EPA; 2) state access for removal activities; 3) payments to federal, state, and Indian tribe trustees to conduct natural damage assessments and restorations; 4) payment of claims for uncompensated removal costs and damages; 5) research and developments; and 6) other specific appropriations (USCG, 2006). Following this analysis, DEP submitted claims for each of the 23 cases analyzed, and all of them were funded. The injuries for all of the claims were pooled into three regional restoration projects. All three of these restoration projects were then also approved.

REFERENCES

- French, D., Reed, M., Jayko, K., Feng, S., Rines, H., Pavignano, S., Isaji, T., Puckett, S., Keller, A., French III, F.W., Gifford, D., McCue, J., Brown, G., MacDonald, E., Quirk, J., Natzke, S., Bishop, R., Welsh, M., Phillips, M. and Ingram, B.S. 1996a. The CERCLA type A natural resource damage assessment model for coastal and marine environments (NRDAM/CME), Technical Documentation, Vol.I - Model Description. Final Report, submitted to the Office of Environmental Policy and Compliance, U.S. Dept. of the Interior, Washington, DC, April, 1996, Contract No. 14-0001-91-C-11.
- French, D., Reed, M., Feng, S., and Pavignano, S. 1996b. The CERCLA type A natural resource damage assessment model for coastal and marine environments (NRDAM/CME), Technical Documentation, Vol.III - Chemical and Environmental Databases. Final Report, Submitted to the Office of Environmental Policy and Compliance, U.S. Dept. of the Interior, Washington, DC, April, 1996, Contract No. 14-01-0001-91-C-11.
- French, D., Pavignano, S., Rines, H., Keller, A., French III, F.W., and Gifford, D. 1996c. The CERCLA type A natural resource damage assessment model for coastal and marine environments (NRDAM/CME), Technical Documentation, Vol.IV - Biological Databases. Final Report, Submitted to the Office of Environmental Policy and Compliance, U.S. Dept. of the Interior, Washington, DC, April, 1996, Contract No. 14-01-0001-91-C-11.
- French, D.P., Rines, H., and Masciangioli, P. 1997. Validation of an Orimulsion spill fates model using observations from field test spills. In: Proceedings, Twentieth Arctic and Marine Oil Spill Program Technical Seminar. Environment Canada, Ottawa, ON.
- French, D. P., Manen, C.A., Gibson, M., and Catena, J. 2001. Quantifying the scale of restoration required to compensate for the impacts of the North Cape oil spill on fish and invertebrates. In: Proceedings of the 2001 International Oil Spill Conference & Exposition. American Petroleum Institute, March 26-29, 2001, Tampa, Florida.
- French McCay, D. 2001. Development and Application of an Oil Toxicity and Exposure Model, OilToxEx. Final Report to NOAA Damage Assessment Center, Silver Spring, MD, January 2001, 50p plus appendices.
- French McCay, D.P. 2002. Development and application of an oil toxicity and exposure model, OilToxEx. Environ. Toxicol. Chem. 21, 2080-2094.
- French McCay, D.P. 2003. Development and application of damage assessment modeling: example assessment for the North Cape oil spill. Mar. Pollut. Bull. 47, 341-359.
- French McCay, D.P. 2004. Oil spill impact modeling: development and validation. Environ. Toxicol. Chem. 23, 2441-2456.
- French McCay, D.P., and Rowe, J.J. 2003. Habitat restoration as mitigation for lost production at multiple trophic levels. Mar. Ecol. Prog. Ser., 264, 235-249.
- French McCay, D.P., and Rowe, J.J. 2004. Evaluation of bird impacts in historical oil spill cases using the SIMAP oil spill model. In: Proceedings of the Twenty-Seventh Arctic and Marine Oil Spill Program (AMOP) Technical Seminar, pp. 421-452. Emergencies Science Division, Environment Canada, Ottawa, ON.
- Jokuty, P., Whiticar, S., Wang, Z., Fingas, M., Lambert, P., Fieldhouse, B., and Mullin, J. 1996. A catalogue of crude oil and oil product properties. 1996 (edition), Report # EE-157, Emergencies Science Division, Environment Canada, Ottawa, Canada (<http://www.etcentre.org/spills>).
- Muin, M., and Spaulding, M. 1997a. Three-dimensional boundary-fitted circulation model. J. Hydraulic Eng., 123, 2-12.
- Muin, M. and Spaulding, M. 1997b. Application of three-dimensional boundary-Fitted circulation model to the Providence River. J. Hydraulic Eng., 123, 13-20.
- Okubo, 1971. Oceanic diffusion diagrams. Deep-Sea Res. 8, 789-802.
- Okubo, A., and Ozmidov, R.V. 1970. Empirical dependence of the coefficient of horizontal turbulent diffusion in the ocean on the scale of the phenomenon in question. Atmos. Ocean Phys. 6, 534-536.
- PERL (Pacific Estuarine Research Laboratory). 1990. A Manual for Assessing Restored and Natural Coastal Wetlands with Examples from Southern California, California Sea Grant, Report No. T-CSGCP-021, La Jolla, California.
- Seneca, E.D., and Broome, S.W. 1992. Restoring tidal marshes in North Carolina and France. In: Restoring the Nation's Marine Environment, Chapter 2, pp. 53-78. (G.W. Thayer, Ed.). Maryland Sea Grant, College Park, MD.

- Spaulding, M.L., Mendelsohn, D., and Swanson, J.C. 1999. WQMAP: An integrated three-dimensional hydrodynamic and water quality model system for estuarine and coastal applications. *Mar. Tech. Soc. Journal* (invited paper, Special issue on state of the art in ocean and coastal modeling), 33, 38-54.
- USCG (U.S. Coast Guard). 2006. The Oil Spill Liability Trust Fund website <<http://www.uscg.mil/npfc/About%20Us/osltf.htm>>, accessed September 2006.
- Wang, Z., Fingas, M.F., Landriault, M., Sigouin, L., and Xu, N. 1995. Identification of alkyl benzenes and direct determination of BTEX and (BTEX + C3-Benzenes) in oils by GC/MS. In: *Proceedings of the Eighteenth Arctic and Marine Oilspill Program (AMOP) Technical Seminar*, pp. 141-164. Edmonton, Alberta, Canada, June 1995.
- Whiticar, S., Bobra, M., Fingas, M., Jokuty, P., Liuzzo, P., Callaghan, S., Ackerman, F., and Cao, J. 1992. A catalogue of crude oil and oil product properties 1992 (edition). Report # EE-144, Environment Canada, Ottawa, Canada, 643p.
- Zedler, J.B. 1992. Restoring cordgrass marshes in Southern California. In: *Restoring the Nation's Marine Environment*, Chapter 1, pp.7-52. (G.W. Thayer, Ed.). Maryland Sea Grant, College Park, MD.

PART XI: Site Assessment

Chapter 34

DIFFICULT SITE CHARACTERIZATION DUE TO TOPOGRAPHIC SITE CONDITIONS AND HISTORIC SITE USE

Ronald Richards¹, Lester Tyrala¹, Christen Sardano¹, and John Zupkus²

¹*Shaw Environmental & Infrastructure, 100 Technology Center Drive, Stoughton, MA 02072;* ²*Massachusetts Department of Environmental Protection, Northeast Regional Office, 205B Lowell Street, Wilmington, MA 01887*

Abstract: Many Brownfield sites contain areas where intrusive investigations cannot be readily conducted due to unstable ground conditions. Described in this paper are the means used at the Former Oxford Paper Mill Site in Lawrence, Massachusetts, to assess and remediate an unstable area containing asbestos and elevated levels of PCBs. An area totaling approximately 35 feet wide by 200 feet long contained many voids created by partial demolition of basements and subsequent backfilling after the mill ceased operations in 1974. It was known that PCB and asbestos contamination was present in this area, but the nature and extent was unknown. This paper describes the use of remote intrusive investigations combined with assumptions regarding site characterization leading to a final assessment of soils in place, and that was utilized to successfully address the problem.

Key words: Brownfields, PCB, asbestos

1. INTRODUCTION

The Former Oxford Paper Mill located in Lawrence, Massachusetts on the Spickett River, and near the river's confluence with the Merrimack River, is best known historically for the glossy paper it produced for use by National Geographic Magazine. By the early 1970s, the business had declined and passed through a several owners. Finally in 1983, the City of Lawrence took the property for back taxes. Trespassers and illegal activities were a frequent problem at the property and subsequently the buildings on the north side of the raceway were demolished. During the demolition process, (for unknown reasons) a strip of the property 35 feet wide and about 200 feet long that abutted the raceway was only demolished to grade level and substantial subsurface voids remained. These subsurface voids made the surface unstable for site activities and the area was cordoned off to prevent trespassers.

The idea of a "Gateway Project," which combined the redevelopment of Brownfields sites in the area with a new bridge over the Spickett River, was developed in the mid 1990s. The City of Lawrence, with funding from various sources, began a program to use the Former Oxford Paper Mill Site as a passive park and for part of the new Bridge over the Spickett River. As part of the project, the 35-foot wide strip was to be excavated, stabilized, and left with a 2:1 slope to the existing water-power raceway.

As part of this site restoration, remediation of soil and groundwater to MassDEP and EPA standards was required. At one point during site investigations, concern was raised when a wipe sample of a brick wall overlooking the north raceway was found to have very high levels of PCBs; the possibility of significantly elevated levels of contamination, including PCBs in that area, was raised. Due to the potential for significant contamination, it was necessary to determine as much as reasonably possible regarding environmental conditions on the 35-foot wide strip of land prior to excavation and disposal.

2. MATERIAL AND METHODS

Various methods of site access for intrusive investigations were reviewed. All vehicle and even personnel travel on the 35-foot wide strip was deemed to be unsafe, as subsidence was clearly seen. All options were reviewed.

A truck-mounted hollow stem auger rig or Geoprobe®, or other specialty rig, was eliminated from consideration due to the unknown subsurface conditions with observed subsidence. A remotely-operated Geoprobe® or track-mounted rig was considered but eliminated from consideration since the ground was too uneven to provide for mobility. In a like manner, tripod rigs and similar manually operated equipment were eliminated from consideration. It was clear that the equipment used would need to be positioned on stable ground next to the 35 foot wide area, and some manner of sampling would be used to obtain samples remotely. After due consideration, it was decided to use a backhoe/excavator to dig 10 evenly spaced test pits.

3. RESULTS

The excavation of the 10 test pits was conducted without any significant problems. The most significant issue was that, due to the presence of foundations in a few locations, the location of the test pit moved slightly with only a marginal increase in the ability to obtain samples at depth. However, all stakeholders agreed that, based on the results of the test pits, excavation and disposal of the wedge materials could be contracted for with a degree of certainty regarding construction costs.

4. DISCUSSION AND CONCLUSIONS

Without major issues, the strip was excavated and disposal of the material completed. Additional soil borings were conducted near the foot of the slope and concentrations of constituents of concern were well within the limits found during previous investigations at the site. The most significant issue became the presence of limestone material that apparently had been used by the paper mill. The limestone raised the pH of the soil close to 12, eliminating some disposal sites. However, in the end, the project was successfully completed.

Chapter 35

DETAILED CVOC SOURCE AREA INVESTIGATION IN THE CONTEXT OF A FRACTURED BEDROCK CONCEPTUAL SITE MODEL

A Case Study

James H. Vernon, Ph.D.¹, Patricia C. Shattuck¹, Mark D. Kauffman, P.E.¹, Drew M. Clemens, P.G.², Robert A. Leitch, P.E.², Donald M. Maynard, P.G.³

¹ENSR International; ²US Army Corps of Engineers, New England District; ³The Johnson Company

Abstract: Dissolved-phase transport of groundwater contaminants through crystalline bedrock fractures is often highly heterogeneous and challenging to conceptualize. Groundwater flow can be restricted to a discrete subset of connected bedrock fractures, while contaminant transport may not be well correlated with the degree of fracture-zone hydraulic activity. While characterizing hydraulic interconnectivity between source areas and receptors and between individual wells is a desired component of a conceptual site model (CSM), scale issues may prevent the identification of specific contaminant pathways or the prediction of contaminant concentrations throughout a site. Detailed characterization in known or suspected contamination source areas, in the context of an existing CSM, not only guides remediation and monitoring strategies, but also will enhance understanding of contaminant transport to potential off-site receptors.

The case study area in coastal Maine is underlain by fractured metavolcanic and intrusive bedrock, present at or near the ground surface. Water levels are as deep as 120 feet in some wells. Groundwater flow is restricted to fractures, lithologic contacts, or faults within the bedrock. Chlorinated volatile organic compounds (CVOCs) discharged on site from past operations have been detected in wells at concentrations varying from more than 3,000 micrograms per liter to below detection limits, with a heterogeneous spatial distribution. A variety of investigations has led to the development of a CSM for the site. Information obtained from detailed source area investigations may allow identification of specific contaminant pathways within the source area, but not at the greater distances that are present between the source area and some receptors.

Investigations, conducted or planned, that focus on the CVOC source areas include: geologic and fracture mapping, surface and borehole geophysical surveys, whole-well and packer sampling, monitoring well installation and angled coring, rock matrix analysis for CVOCs, rock mass characterization, soil sampling, photolineament analysis, borehole radar investigation, hydrophysical logging, packer sampling, and water level monitoring. A combination of conventional and less frequently-applied techniques has allowed an assessment of contaminant transport pathways in the source area, a refinement of the CSM for the overall site, and a more direct evaluation of remedial options.

Key words: CSM, CVOC, fractured bedrock, heterogeneity, geophysics

1. INTRODUCTION

Groundwater flow and the transport of dissolved-phase, chlorinated volatile organic compounds (CVOCs) through fractured crystalline bedrock depend on a distribution of interconnected permeable pathways within the rock mass. The geometry and hydraulic conductivity of these pathways are difficult to characterize, but these attributes have a major impact on the degree of success in designing, implementing, and monitoring a remedial program.

This paper presents a case study from a former Air Force Radar Tracking Station (AFRTS) in Bucks Harbor, Maine. Groundwater in some locations in and near the former AFRTS is impacted with dissolved CVOCs, principally trichloroethylene (TCE) (Weston, 2005). A conceptual site model (CSM) for the hydrogeology of the fractured bedrock at the site provides context for summarizing selected results of an ongoing investigation of one of the Bucks Harbor source areas. Due to the comprehensive volume of field data collected for this project to date, discussion of results here focuses on bedrock fracture characterization, observed hydraulic gradients within and between wells, distribution of TCE within a suspected source area, and implications for contaminant transport.

The former Bucks Harbor facility is located in Machiasport, Maine, approximately 25 miles from the Canadian border (Weston, 2005). The Bucks Harbor facility was used by the U.S. Air Force as a radar tracking station (AFRTS) from 1954 to 1984 (ABB Environmental Services, Inc. (ABB, 1997). The remainder of this paper focuses on ongoing investigations in the Howard Mountain source area (Figure 1). Although the history and exact locations of contaminant releases are not fully known, anecdotal information (Weston, 2005) indicates that various locations near the Howard Mountain summit were source areas for TCE.

2. GEOLOGIC SETTING

The topography (Figure 1) is characterized by low, glacially-modified coastal mountains with intervening valleys. Ground elevations in the study area range from sea level to greater than 250 feet on the summit of Howard Mountain (Figure 1). The east flank of Howard Mountain is a cliff, with a gravel pit below.

The Howard Mountain summit area (Figure 1) is believed to be a source area for groundwater impacts due to the release of TCE and other CVOCs onto the ground. Domestic drinking water supply wells are located on the flanks or at the bases of the mountains. Some of these wells are impacted, while others are not.

Overburden deposits are generally thin (20 feet or less) or absent over most of the higher portions of Howard Mountain. Extensive cliffs or other outcrops are present east, north and west of the Howard Mountain summit. Where present, overburden generally consists of artificial fill or glacial till in most portions of the Bucks Harbor area.

The study area is underlain by igneous and/or metamorphic bedrock, including the lower Devonian Eastport formation, penecontemporaneous diabase and gabbro intrusives, and other mapped formations (Gates, 1981, 1982). The Eastport formation includes metavolcanic basalt, andesite, tuff-breccia and rhyolite (Gates, 1982). Banded rhyolite and vitrophyre are the most commonly-observed of the Eastport formation rocks in the study area (Weston, 2005). Devonian plutonic rocks, including mafic intrusives as well as various metasedimentary rocks, are also mapped nearby (Gates, 1981, 1982).

It is noted that metamorphic structures and tectonic belts in the region trend northeast-southwest (Gates, 1981, 1982). A mapped fault zone that trends north-northwest to south-southeast (NNW/SSE) transects the study areas along the northeast flank of Howard Mountain with the down-dropped block to the east of the fault (Gates, 1981, 1982). Because of its linear trace in plan view, a steep dip for the fault can be inferred (Gates, 1981). The fault or fault zone probably underlies the gravel pit that occurs at the base of the cliffs along the northeast flank of Howard Mountain (Argonne National Laboratory, 2005) and may be about 1000 feet wide (Figure 1).

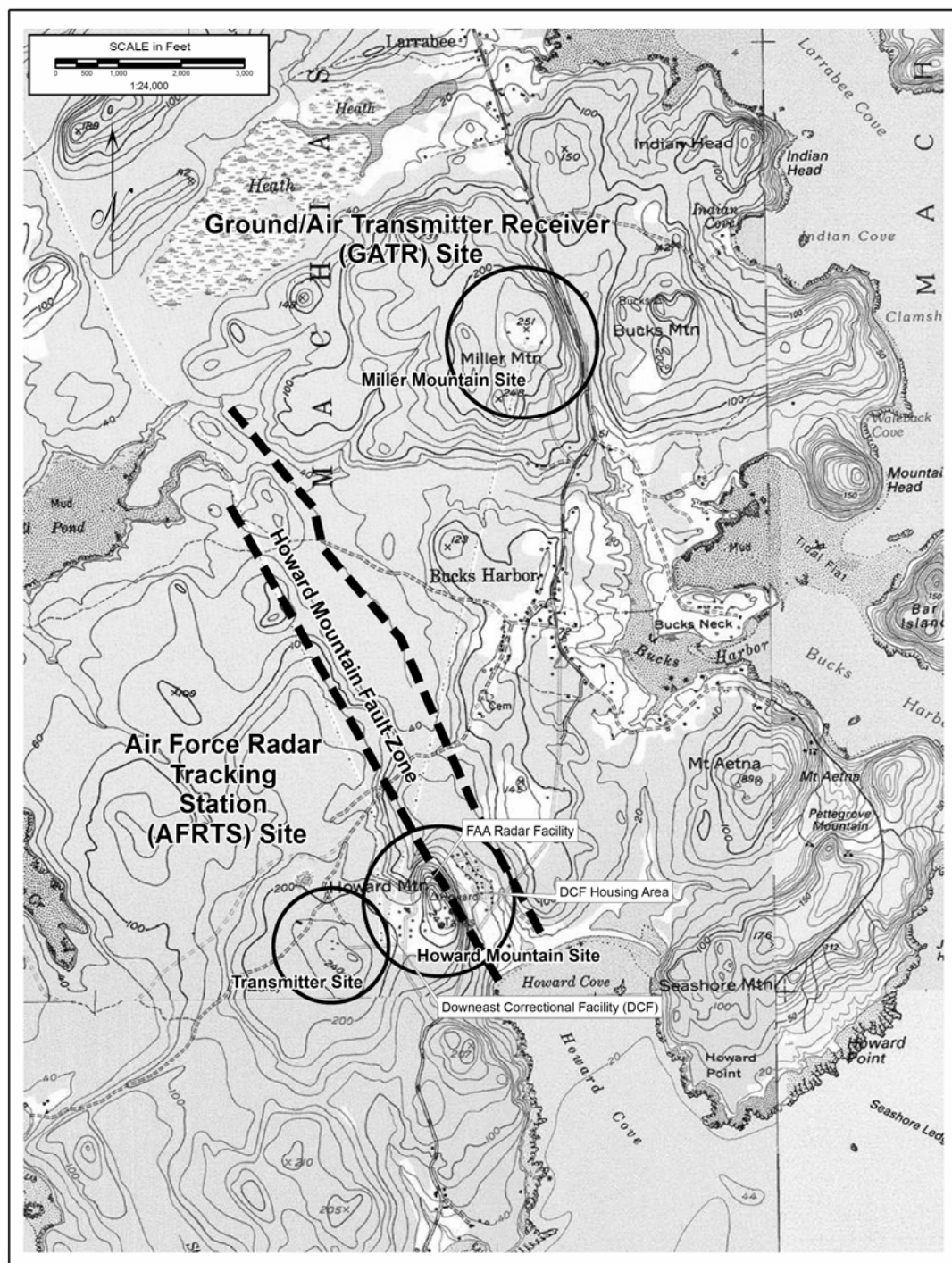

Figure 1. Case Study Area Site Map

Bedrock fractures have been measured at outcrops in the study area and interpreted from borehole acoustic televiewer (ATV) and optical televiewer (OTV) logs in bedrock wells. These fractures strike in a variety of directions, with the most common orientations reflecting the regional tectonic strike, northeast, and the mapped fault orientation, north-northwest (Weston, 2005; USGS, 2006). In the metamorphic and igneous rocks in the study area, primary porosity and permeability are probably negligible. For groundwater to occur in storage or to flow in these rocks, secondary porosity and

permeability, derived from openings such as fractures, faults, metamorphic foliation, fractured bedding planes, or weathered zones, must be present.

3. METHODS

The investigations described in this paper are ongoing and are part of a Remedial Investigation (Weston, 2005) and Feasibility Study (ENSR, 2006) for the Bucks Harbor site. Detailed investigations at the Howard Mountain source area include geologic and lineament mapping and bedrock fracture measurement; vertical and inclined bedrock drilling, coring, rock mass assessment, and monitoring well installation; borehole geophysical surveys (including geology, image, and borehole radar tools); water level monitoring; whole well water sampling and analysis; both depth-specific standard and wireline straddle packer sampling; flow characterization using hydrophysics and vertical heat pulse flow meter; overburden trenching; spring/seep sampling; and surface geophysical surveys (EM, 2D Resistivity, GPR, refraction tomography).

Inherent in bedrock site investigations is the logical sequence of site evaluation tasks and the need to refine the scope of each task based on the results of the previous task. This logical sequence of the tasks begins with the evaluation of the available data followed by non-invasive site investigation tools as listed above. Invasive investigations such as test pits and trenches, soil and bedrock boring, bedrock coring, angled boring and coring, monitoring well construction, and soil and groundwater sampling follow as appropriate. The case study described here employs the Triad approach (U.S.EPA, 2004), which allows scoping flexibility that has been crucial to the success of this project.

4. RESULTS AND CONCEPTUAL SITE MODEL

According to the conceptual site model (CSM), the most significant geologic structure in the area is the Howard Mountain Fault Zone, which occurs along the eastern edge of Howard Mountain (Figure 1) and trends NNW/SSE (Gates, 1981). Photolineaments (MGS, 1986; ABB, 1995; and USACE, 2004) and topography suggest that a fault zone associated with the Howard Mountain Fault may extend from the cliffs on Howard Mountain, eastward approximately to an unnamed brook (Figure 1).

A compilation of bedrock fracture measurements from outcrops (ABB, 1995; USACE, 2004; ENSR, 2006) and ATV and OTV interpretations (USGS, 2004, 2006, Weston, 2005) indicate that within the fault zone, NNW-striking fractures are strongly predominant. In the vicinity of former Buildings 114 and 501, located near the Howard Mountain summit, NNW-striking fractures with steep dips are common (dominant near Building 114) with NE-striking fractures with steep and moderate dips also present, especially near Building 501 (ENSR, 2006). A study of fracture spacing and length (USACE, 2004) at an outcrop on the southwest flank of Howard Mountain indicates that the mean fracture length ranges from 1.6 to 2.7 feet, while the mean fracture spacing ranges from 0.30 to 0.89 feet. In both cases, the statistical distribution (of length and spacing) is log normal or exponential, so a few fractures that are much longer can be expected. Likewise, occasional blocks of rock with greater fracture spacing (less fracture density) can also be expected.

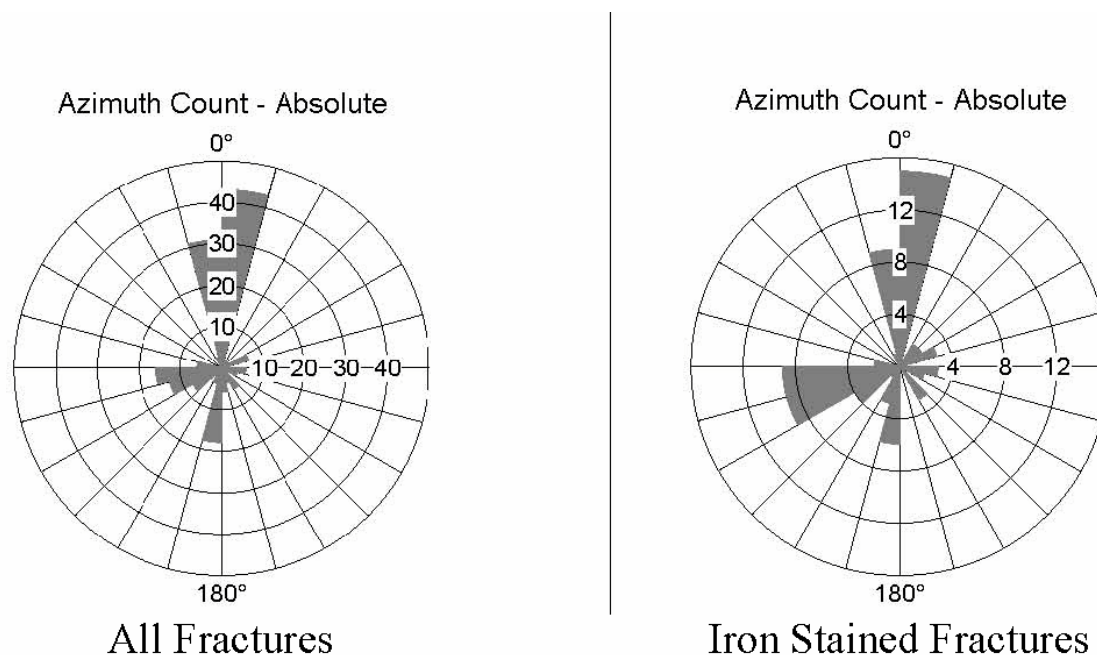

Figure 2. Rose diagram of Fracture Dip Azimuths (True North) in 45-degree angle core C-114

Borehole radar surveys of Howard Mountain wells MW-09 and MW-10 (USGS, 2004) reveal that a significant number of radar reflectors that may represent fractures are present in the rock mass. Many of these can be projected to intersect either the well bores or the ground surface (USGS, 2004). Moderate to steeply-dipping radar reflectors with a variety of strikes are prevalent in the MW-09 vicinity, and steeply dipping fractures that strike NNW or NE are prevalent in the MW-10 (Building 114) area.

A 45-degree angle hole (C-114) was continuously cored into the rock beneath one of the presumed source areas, the former Building 114. The use of an angled borehole resulted in the penetration of numerous high-angle, near-vertical fractures. The rock core was inspected and described in detail, and two distinct sets of fractures were observed. One fracture set was generally filled and sealed with secondary chlorite deposition, while the second fracture set was unsealed, and generally had orange iron oxide staining associated with it.

Borehole geophysical surveys (Johnson Company, 2006) were combined with the core observations to evaluate the significance of the two fracture sets: the iron oxidized set (indicative of water percolation) and the relatively impermeable chlorite filled fractures. While the dominant fracture orientation dips to the north, most of these fractures are chlorite filled. In contrast the iron oxidized fractures, which serve as the most probable pathway for CVOC migration to groundwater, dip both north and west (Figure 2). The interconnectivity of the north and west dipping iron stained fractures, observed at many depths in the C-114 core, may allow “stair-step” or zigzag migration of CVOCs rather than preferential travel down strike or dip along fractures.

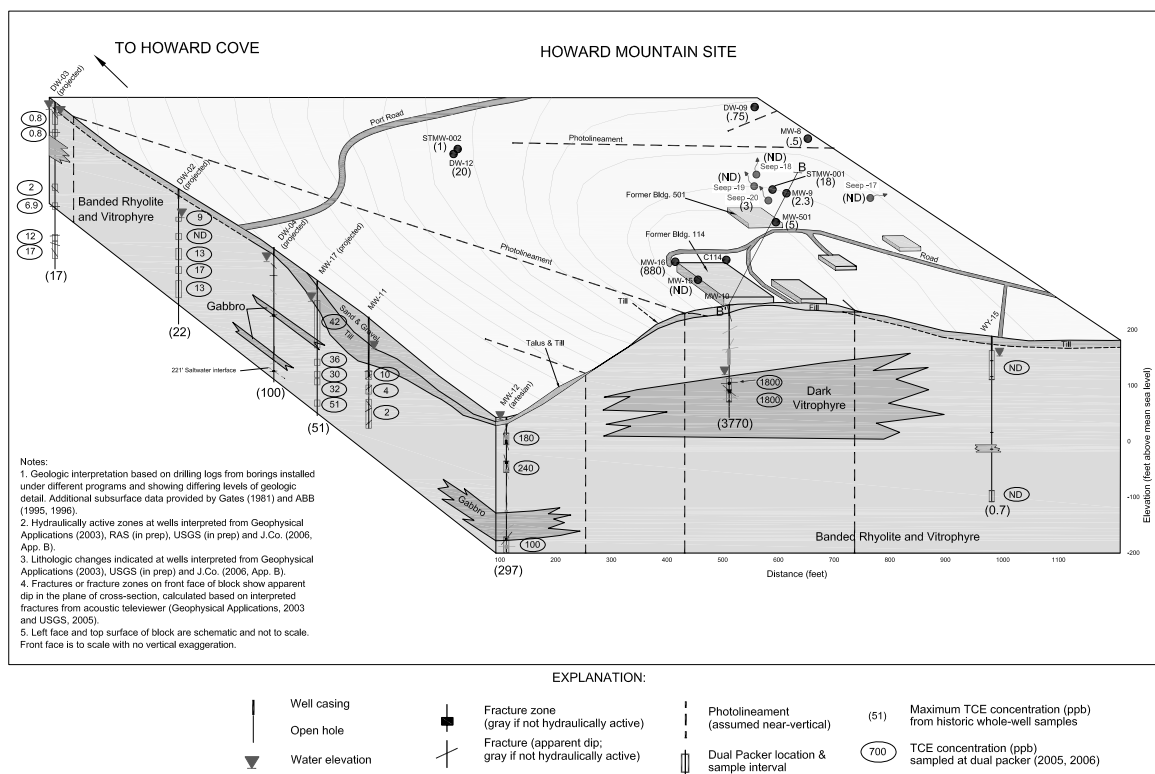

Figure 3. Howard Mountain Block Diagram

As described above, sources of fracture information for the Howard Mountain summit area include air photolineament analysis, outcrop fracture measurement, borehole geophysics, and core description. The fracture network constitutes the potential pathways for groundwater flow and contaminant transport. North-northwest and northeast fracture strikes are generally prevalent at the site and north and west are the two most prevalent dip directions in the C-114 core. While this characterization has probabilistic implications for flow and transport directions, discrete pathways comprising a subset of intersecting fractures probably dominate dissolved TCE transport in the Howard Mountain summit area.

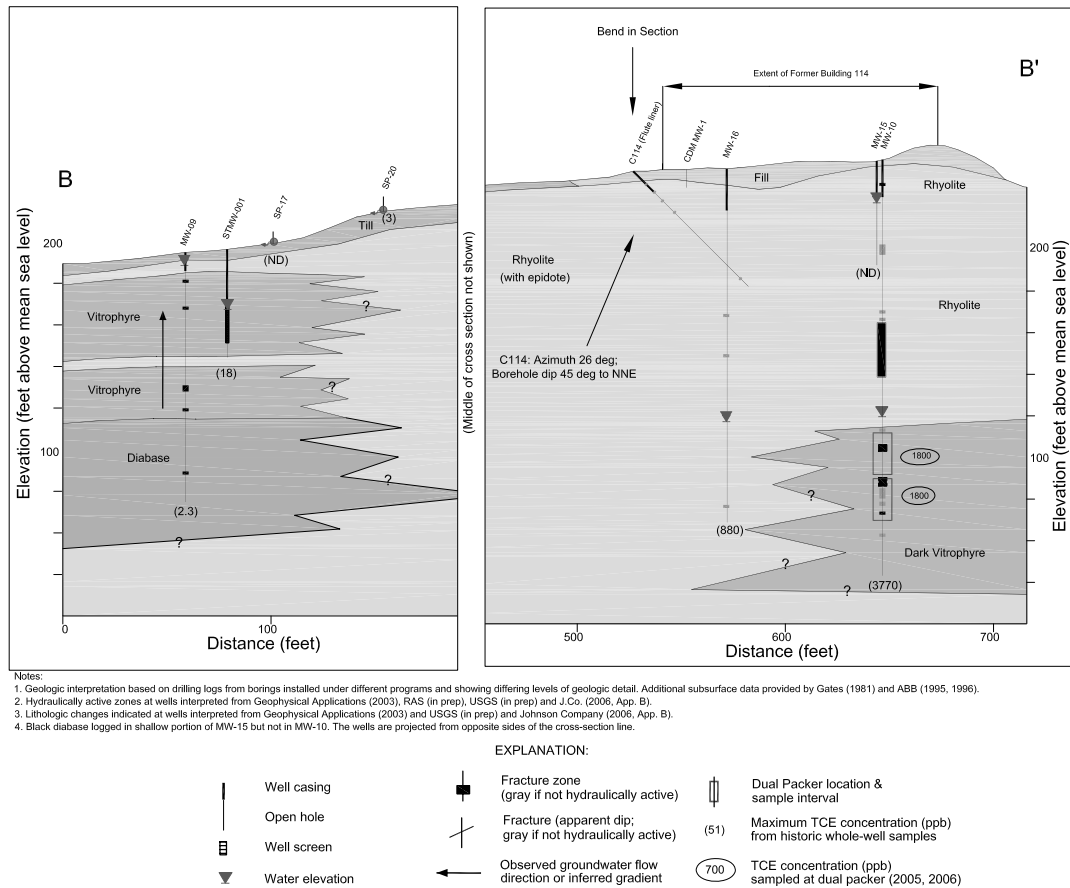

Figure 4. Howard Mountain Geologic Cross Section

In the summit area, the overburden is often unsaturated or only intermittently saturated. According to the CSM, water that enters the overburden can be expected to infiltrate downward. When the water reaches the bedrock surface, it may collect locally, flow laterally across the impermeable bedrock surface, or infiltrate into a bedrock fracture zone. If the fracture is part of an interconnected permeable network, the infiltrated water moves downward until it reaches the potentiometric surface. If not, the water may remain stagnant in a disconnected fracture or infiltrate extremely slowly, thus remaining perched above the local potentiometric surface. In the metamorphic and igneous rocks in the study area, significant primary porosity and permeability are not expected. For groundwater to occur in storage or to flow in these rocks, secondary porosity and permeability derived from openings such as fractures, faults, metamorphic foliation, fractured bedding planes, or weathering must be present. At some scale, however, individual wells or fractures may be hydraulically isolated from each other, resulting in significant head gradients that do not necessarily lead to flow. Groundwater in fractured bedrock generally flows in response to regional hydraulic gradients, and follows tortuous pathways. The degree of interconnectedness of fractures appears to be highly variable, which affects groundwater flow paths and contaminant migration. At the Bucks Harbor site, some individual wells and fractures that are proximate to one another appear hydraulically isolated from each other (ENSR, 2006). In such cases, significant local head gradients develop but do not necessarily lead to flow.

For example, in the Howard Mountain summit area, the water levels in well MW-10 and MW-16 are approximately 120 feet below the ground (Figures 3 and 4). However, water-bearing fractures have been encountered at shallower depths than the observed water levels in these wells. For example, the water level is less than 20 feet below ground in monitoring well MW-15, which is located approximately 32 feet from MW-10 and is only 50 feet deep. The observed water level in an open-hole bedrock well that intersects more than one water-bearing fracture zone is a composite head.

This water level depends on both the head (pressure) and flow characteristics of the water in each fracture that intersects the well.

The approximate 100-foot difference in water levels between wells MW-10 and MW-15, which are located only 32 feet apart, indicates that the wells are not hydraulically connected. This suggests that the following may be true at the Howard Mountain Site: First, the shallow water-bearing fractures that supply water to monitoring well MW-15 (between bottom of casing at 15 feet below ground (ft bg) and 17.5 ft bg) may not extend laterally to monitoring well MW-10 (or MW-16) or connect with fractures that intersect those wells. An alternate or additional explanation is that fractures that provide water to well MW-10 (Figure 4) do not intersect with the MW-15 borehole either because they extend beneath the bottom of the MW-15 borehole or because they do not extend far enough laterally to reach it.

The primary chemicals of potential concern remaining at the Bucks Harbor facility are chlorinated aliphatic volatile organic compounds (CVOCs) in groundwater (Weston, 2005). Trichloroethylene (TCE) is the primary CVOC that has been detected, and as such, has been the primary focus of site investigations. The highest concentrations of TCE at the Bucks Harbor facility have been detected in the vicinity of Howard Mountain. The area downgradient of Howard Mountain is also the area where most interim groundwater treatment measures (i.e., residential well GAC treatment systems) have been implemented to prevent human exposure to impacted groundwater. Therefore, more data has been collected to characterize the Howard Mountain area than the remainder of the site (ENSR, 2006).

TCE concentrations in Howard Mountain wells vary with both location and depth (Figures 3 and 4). The well that has recorded the highest TCE concentration (MW-10; TCE as high as 3770 ug/L) is only 32 feet from MW-15, in which TCE was not detected when it was first sampled in April 2006. New well MW-16 is also in the Building 114 area and has a TCE level of 880 ug/L (ENSR, 2006). Because well MW-15 is considerably shallower than wells MW-10 and MW-16 (Figure 4), the data suggest that there may not be a shallow bedrock source of TCE in the former Building 114 area. The fracture(s) that supply water to MW-15 (between 15 and 17.5 ft bg) appear perched roughly 100 feet above the water levels in the deeper wells (Figure 4) and thus are not likely to be hydraulically connected to deeper fractures that transport groundwater with dissolved TCE.

At wells MW-09 and STMW-001, located southwest of the former Building 501 (Figures 3 and 4), the situation is reversed, with the deeper well (MW-09) of the pair having the higher water level and the lower TCE concentration. These observations suggest both an upward hydraulic gradient, as well as the presence of a hydraulically active shallow bedrock fracture that exhibits TCE contamination. A TCE detection (3.0 ug/L) in Seep-20 (Figures 2 and 3), located south of former Building 501, also indicates that TCE remains in soil or in a shallow bedrock fracture in this vicinity.

Domestic and monitoring wells south, southeast, and east of the Howard Mountain summit are the primary potential receptors in the Howard Mountain area. Groundwater impacts are absent or occur only in low concentrations in available wells located in other directions from the suspected source areas (Weston, 2005), although steeply dipping fractures carrying TCE-impacted groundwater could have been missed by existing wells. TCE concentrations at the Bucks Harbor sites show considerable variation both in map view and with depth within some of the wells (Figure 3). Further, certain fractures carry TCE impacted groundwater, while others carry clean or relatively clean groundwater.

Based on dual-packer sampling, the TCE distribution is fairly uniform with depth in some locations on Howard Mountain (i.e., monitoring wells MW-10, MW-11, and MW-17), whereas it varies with depth elsewhere. In monitoring well MW-12, TCE concentrations are higher in the top 100 feet than they are below 200 feet, whereas in well DW-03, TCE concentrations appear to increase with depth (Figure 3). The total depth of TCE impacts in the source area has not been determined. The variable distribution of TCE in three dimensions at Howard Mountain suggests that discrete fracture pathways (as opposed to an effectively porous medium) are responsible for the flow of either impacted or non-impacted groundwater at the scale of investigation.

5. DISCUSSION

The near absence of TCE in samples collected from MW-15 and another shallow monitoring well in the Building 114 area of the Howard Mountain summit area (ENSR, 2006) and in soil samples collected from the overburden (ENSR, 2006; Johnson Company, 2006) indicates that it is unlikely that secondary sources of TCE remain in soil or the shallow bedrock underlying Building 114. The results are more indicative of residual TCE in poorly connected or small aperture-width bedrock fractures, which continues to provide a secondary source of TCE dissipating through the underlying aquifer. The fact that mean fracture length is generally greater than mean fracture spacing suggests that a number of fracture intersections should be present. Outcrop observations, C-114 core observations (Johnson Company, 2006), and borehole televiewer observations (Weston, 2005; USGS, 2006) confirm the presence of fracture intersections.

In the former Building 114 area, water-bearing fractures that do not contain dissolved TCE are present in the bedrock at depths shallower than 50 feet. In the same area, fractures that intersect boreholes at depths between 50 and 200 feet contain dissolved TCE at concentrations greater than 500 ug/L. These fractures are apparently not hydraulically connected to the shallower fractures in MW-15. These observations suggest that wells that are installed to perform or monitor remedial activities (such as the injection of *in situ* oxidants) in the former Building 114 area need to penetrate to depths of at least 50 to 200 feet and may need to be spaced at distances of 32 feet or less from each other in order to reach the TCE-impacted fracture systems. Future investigations such as pumping or injection tests and monitoring of conductive injectate transport using borehole radar may refine the parameters regarding remedial injection and monitoring wells.

In the former Building 501 and MW-09 area of Howard Mountain, TCE-impacted groundwater is present in shallow bedrock fractures and possibly overburden (near Seep-20). Upward groundwater gradients exist in the MW-09 area. Also, MW-09 is an open borehole, while adjacent shallow well STMW-001 is screened in shallow bedrock (Figure 4). In MW-09, the more transmissive fractures have a dominant effect on the composite water level. Present data do not allow the identification of the specific fracture or fractures that contribute TCE-contaminate groundwater to the well. Some of the water-bearing fractures that intersect the borehole may be non-impacted. Remedial and monitoring wells that may be installed in the former Building 501 and MW-09 area should be designed to intercept shallow bedrock fracture zones.

Site characterization in a crystalline bedrock environment is a costly undertaking with inherent uncertainty. This necessitates the assimilation of aerial photography review, historical document review and published data review with the results of the non-invasive field efforts (bedrock outcrop fracture measurements, site surveys, surface geophysics and groundwater testing) to design the field program subsurface tasks (monitoring well installation, test pits, rock coring, geophysical anomaly excavation, packer sampling and water level monitoring equipment installation). The approach is both sequential and iterative, with the current CSM resulting from investigations to date and also guiding planned future investigations. These include hydraulic and/or dye tracer testing, which will be needed prior to the remedial action implementation.

6. CONCLUSIONS

The Howard Mountain summit area is the site of a former United States Air Force radar tracking station (AFRTS) where TCE was disposed of on the ground in various locations from the 1950s through the 1980s. The Howard Mountain summit area is underlain by thin, generally unsaturated overburden and fractured, banded rhyolite and dark vitrophyre, along with occasional mafic dikes. Fractures with a variety of strikes and dips are present, but northeast and north-northwest-striking fractures with steep dips are predominant. North-northwest-striking fractures are especially prevalent along the eastern portion of the Howard Mountain summit area, adjacent to a regional, high-angle fault zone located immediately east of the summit area. These fractures provide a complex network of groundwater flow paths, some of which carry groundwater with no TCE contamination, and others

of which are impacted. The concentrations of TCE vary in map view and with depth and do not necessarily decrease or increase with depth or distance from the suspected source area(s) near Buildings 114 and 501 on the Howard Mountain summit.

Differences in observed well water levels of over 100 feet in wells as close together as 32 feet suggest that different fracture systems within the source area may be hydraulically isolated from each other. The distribution and concentration of TCE in groundwater indicates the same phenomenon in some locations. Describing and quantifying hydraulic connections and lack of connections in the Howard Mountain source area has direct implications for optimizing remedial and monitoring design.

The studies described in this paper were performed under the direction of the U.S. Army Corps of Engineers (USACE), New England District (NAE). USACE is the lead federal agency managing this work, under the federal Defense Environmental Restoration Program (DERP) for Formerly Used Defense Sites (FUDS). Several contractors, subcontractors, and governmental agencies have participated in the ongoing Bucks Harbor project. Current contractors include ENSR Corporation, the Johnson Company, and Weston Solutions. Geophysical services have been provided by Geophysical Applications, Inc., RAS, Inc., Hager-Richter Geosciences, Inc., the USGS, and Argonne National Laboratory. Staff members of all firms and agencies who participated in the project are thanked. Erik Anderson of ENSR assisted with figure preparation.

REFERENCES

- ABB Environmental Services, Inc. 1995. Final Fracture Trace Analysis Report, Bucks Harbor Former Air Force Radar Tracking Station, Machiasport, Maine.
- ABB Environmental Services, Inc. 1997. Engineering Evaluation of Contamination Report, Bucks Harbor Former Air force Radar Tracking Station, Machiasport, Maine.
- Argonne National Laboratory. 2005. Geophysical Investigation of the Formerly Used Defense Site, Machiasport, Maine.
- ENSR Corporation. 2006 (In Preparation). Feasibility Study, Bucks Harbor Former Air Force Radar Tracking Station, Machiasport, Maine.
- Gates, O. 1981. Bedrock Geology of the Machias, Columbia Falls, and Great Wass Island Quadrangles, Maine. Maine Geological Survey, Department of Conservation, Open File No. 81-11.
- Gates, O. 1982. Brittle Fractures in the Eastport 2-degree Sheet, Maine.
- Geophysical Applications. 2003. Borehole Geophysics Logging Report, Bucks Harbor Former AFRTS, Machiasport, Maine. (contained in Weston, 2005).
- Johnson Company. 2006 (In Preparation). Field Report of Spring 2006 Field Investigation, Former Bucks Harbor Radar Tracking Station, Machiasport, Maine. (as Appendix B, ENSR, 2006).
- Maine Geological Survey, Department of Conservation. 1986. Lineaments, High-Yield Bedrock Wells, and Potential Bedrock Recharge Areas, Prepared by Caswell, Eichler, and Hill, Inc., Open File No. 86-69.
- USACE. 2004. Lination Analysis of the Bucks Harbor Area, Maine, report by Judy Ehlen and Robert L. Fischer. USACE Topographic Engineering Center, Alexandria, Virginia.
- U.S.EPA. 2004. Improving Sampling, Analysis, and Data Management for Site Investigation and Cleanup. EPA-542-F-04-001a.
- USGS. 2004. Analysis of Borehole-Radar Reflection Data from Machiasport, Maine, December 2003. Scientific Investigations Report 2005-5087.
- USGS. 2006 (In Preparation). Borehole-Geophysical Investigation of a Formerly Used Defense Site, Machiasport, Maine: November 2004 – May 2005. Scientific Investigations Report 2006-xxxx.
- Weston Solutions, Inc. 2005. Remedial Investigation, Former Bucks Harbor Air Force Radar Tracking Station, Machiasport, Maine. Final Remedial Investigations Report.

Chapter 36

A BROWNFIELD MODEL COLLAPSES UNDER THE WEIGHT OF LITIGATION:

City of Wichita v. Trustees of the Apco Oil Corporation Liquidating Trust

©Copyright 2004 Computer Law Reporters, Inc.

This article is reprinted with permission of Computer Law Reporters, vol. 48, no. 5, 2004

Neal H. Weinfield
Greenberg Traurig, LLC, Chicago, Illinois

Abstract: This presentation will focus on the City of Wichita's largely failed efforts to collect its response costs for remediating the Gilbert & Mosley Site ("Site"), one of the premier Brownfield redevelopment models. In *City of Wichita v. Trustees of the Apco Oil Corporation Liquidating Trust*, 306 F. Supp. 2d 1040 (D. Kansas 2003), the Court held that if properly used, computer models are invaluable in estimating the size of overlapping contaminant plumes. Both parties used computerized groundwater modeling to determine the plume sizes allegedly migrating from each source, and mathematical computations to allocate orphan shares within the Site. Both parties agreed that where plumes overlapped, the overlapped area should be divided by the number of PRPs whose plumes contributed to the overlap. However, the parties then parted ways. The City proposed two allocation models; the Trustees evaluated six allocation models. The City's groundwater modeling expert modeled parent CVOCs for some sources, and daughter CVOCs for others; the Trustees' expert modeled parent CVOCs for some sources, and daughter CVOCs for others; the Trustees' expert modeled both parent and daughter CVOCs for all sources. The City saddled the last two defendants remaining at trial with the entire orphan share; the trustees argued that they should be saddled with little if any orphan share. Both parties used the same computer model, but inputted different variables. Faced with competing modeling, the Court reasoned that "even in the best of circumstances, a model is only an estimate and the accuracy of the estimate depends to a considerable extent on the data selected for use in the computer model, the quality and reliability of that data and, of course, the skill of the modeler." Ultimately, the Court rejected the City's modeling base don *Daubert*, holding that, "To be reliable, the expert's testimony must be based on the 'methods and procedures of science' and reflect more than the witness' 'subjective belief or unsupported speculation.'" After examining glaring errors in the City's modeling, the Court rejected the City's methodology because it was not based on any guidelines or standards, but rather on poor quality "professional judgment". The presentation will delve into groundwater modeling, modeling presentation, allocation, *Daubert* principles, and witness creditability.

1. INTRODUCTION

The City of Wichita's Gilbert & Mosley Site ("Site") has long been recognized as one of the premier models for urban Brownfield redevelopment. In a recent decision, however, the City was rebuked in its efforts to collect the largest portion of its response costs. In *City of Wichita v. Trustees of the Apco Oil Corporation Liquidating Trust*, 306 F. Supp. 2d 1040 (D. Kansas 2003), the United States District Court for the District of Kansas ruled that the City could not saddle polluters with the large orphan share at Site. The Court's ruling was based upon its findings that the City inadequately investigated contaminant sources, assumed liability for numerous properties, and delayed implementation of remedial measures. The Court also held that liability could be apportioned among parties responsible for commingled contamination based on computer modeling. This holding further

weakens the doctrine of joint and several liability that in large part has predominated in cost recovery and contribution actions. The ruling has far-reaching implications for municipalities involved in Brownfield projects suing, or contemplating suing, multiple contamination sources, as well as parties seeking to allocate liability for commingled contamination.

The case involved liability under the Comprehensive Environmental Response, Compensation and Liability Act (“CERCLA”) for cleaning up the six square-mile Site contaminated with chlorinated volatile organic compounds (“CVOCs”). The Site consists of seven large CVOC-contaminated groundwater plumes. Within each of these plumes, there are a number of smaller overlapping CVOC plumes. Because the larger and internal CVOC plumes both consist of CVOCs, field data and computer modeling was necessary to differentiate the plumes.

As a result of the Site's pollution, the City was allegedly faced with a substantial erosion of its property tax base. Due to the uncertain nature of environmental liability, banks were purportedly unwilling to provide financing for real estate transactions within the Site. To address these issues, the City assumed liability for much of the contamination and funded the investigation and remediation of the Site through tax increment financing. The City then sought to recover its response costs by suing certain potentially responsible parties (“PRPs”).

Despite the presence of thousands of properties within the Site, the City sued just 26 parties. All but four parties settled, most paying for a portion of so-called “orphan shares,” areas of contamination that were attributed to defunct or insolvent parties, and a portion of so-called “unmodeled areas,” areas of contamination that allegedly could not be attributed to any party. Contamination in these two types of areas covered nearly 40% of the Site. The City recovered approximately \$5,000,000-\$9,000,000 through settlement. The City alleged that the Trustees of the APCO Oil Corporation Liquidating Trust (“Trustees” or “ALT”), were liable for contamination migrating from 1001 E. Lincoln which was formerly owned and operated by Apco Oil Corporation. The City admitted that 1001 E. Lincoln was the most downgradient source in Plume B, one of the larger plumes at the Site.

The two-month long trial² against the four remaining defendants delved into such issues as groundwater contaminant plume modeling, compliance with the National Contingency Plan, source identification, remedy selection, municipal contract procurement, data quality and allocation. Ultimately, the most stunning aspect of the Court's decision was its allocation of liability.

The Court held the Trustees liable for 1.72% of the \$22,000,000 groundwater cleanup, rather than the millions sought at trial.³

2. ALLOCATION ANALYSIS

Section 113(f) of CERCLA provides that “[i]n resolving contribution claims, the Court may allocate response costs among liable parties using such equitable factors as the Court determines are appropriate.” 42 U.S.C. § 9613(f)(1). Both parties admitted, indeed contended that CERCLA does not mandate a single allocation method. Thus, there may be many appropriate liability apportionment methods. Both parties used a three-step allocation scheme. First, based on computerized groundwater modeling, the parties calculated the size of the plumes allegedly migrating from each source. Second, this raw plume size was increased through a mathematical computation to include certain “unmodeled areas” that, while within the Site, could not be attributed to any particular PRP. Third, the areas where the alleged plumes from PRPs overlapped was divided by the number of PRPs whose plumes contributed to the overlap. For example, if an area of contamination was caused by two different sources, each source was allocated one half of the liability for the overlapped area of groundwater contamination.

However, that is where the parties parted ways. The City proposed two allocation models; the Trustees evaluated six allocation models.⁴ The City's groundwater modeling expert modeled parent CVOCs for some sources, and daughter CVOCs for others; the Trustees' expert modeled both parent and daughter CVOCs for all sources. The City sought to saddle the few remaining defendants at trial with the entire orphan share; the Trustees argued that they should not be saddled with any orphan share, or at most, an orphan share proportionate to their liability. The City sought to allocate

defendants a proportionate share of the entire “unmodeled area,” even if the unmodeled area was upgradient, “separate” or “distinct” from the defendant’s plume; the Trustees proposed allocating to a defendant only those unmodeled areas contiguous with such defendant’s plume, and then only one half of that area.

Using its most aggressive allocation scheme, the Trustees argued that the City sought to increase the Trustees’ raw plume size approximately eleven fold. For example, the settled Coleman Corporation, whose plume was about eight times larger than the plume migrating from 1001 E. Lincoln, was allocated only 18% more response costs than the Trustees. In fact, the City’s allocation scheme was so aggressive that, while there were a number of settlements in excess of the non-orphan allocated share, these amounts were not credited against the allocation to the remaining defendants.⁵ Ultimately the Court sided with the Trustees on allocation.⁶

2.1 Allocation of Liability for Commingled Groundwater Plumes Based on Groundwater Modeling

In a significant breakthrough, the Court apportioned liability for commingled contaminant plumes using computer modeling. Courts have often imposed joint and several liability on parties that caused indivisible harm because of commingled contaminant plumes. While statutorily only available under CERCLA § 107 cost recovery actions, joint and several liability has often worked its way into contribution actions under CERCLA § 113 when multiple parties were alleged to have contributed to the contamination.⁷ In such instances, courts have often required defendants to provide evidence apportioning harm pursuant to the principles provided in the Restatement (Second) of Torts (“Restatement”) § 43 3A, a difficult burden. *See, United States v. Hercules, Inc.*, 247 F.3d 706, 717 (8th Cir. 2001). The Restatement provides that two parties can apportion damages for harm they caused by showing the harms are distinct or by offering a reasonable basis to determine the contribution of each party.⁸ Defendants in a CERCLA § 113 contribution action can, in theory, apportion their liability based on the waste’s relative toxicity, migratory potential, extent of migration, distinct geographical area,⁹ release chronology (time) and contamination volume. *U.S. v. Hercules*, at 247 F.3d at 718; *U.S. v. Alcan Aluminum*, 990 F.2d at 711, 722 (2nd Cir. 1993); *U.S. v. Alcan Aluminum*, 964 F.2d at 270 n. 29, 271; *U.S. v. Broderick*, 862 F. Supp. 272, 276-77 (D. Colo. 1994). However, with few exceptions, courts have refused to acknowledge a divisibility of harm in cases where contaminant plumes have commingled.¹⁰

In *City of Wichita*, both parties engaged in computer modeling to determine the size of each source’s groundwater contaminant plume. The Court held that “if properly used, computer models appear to be an invaluable tool in approximating the complexities of underground fluid flow.” 306 F. Supp. 2d at 1106. “Through modeling, reservoir flow and contaminant transport can be calculated using complex mathematical operations that simulate the aquifer characteristics. From that effort, the model can simulate the progression of contaminant plumes from each source, thereby providing an estimate of the size of each plume at any given time.” *Id.* “This is especially true when there is extensive and overlapping contamination from multiple sources, where contamination cannot be traced entirely to a specific source and when the extent of contamination is difficult to determine by ‘field methods’ such as geoprobing and drilling test wells.” *Id.* at 1108.

Both parties used the same computer model, CDM’s proprietary Dynflow and Dyntrac models, to make an “apples-to-apples” comparison. However, the experts inputted different variables. The experts derived the variables by interpreting field data, using various default parameters, and applying basic chemistry. Faced with competing modeling, the Court had to select the most accurate model.

“Nevertheless, even in the best of circumstances, a model is only an estimate and the accuracy of the estimate depends to a considerable extent on the data selected for use in the computer model, the quality and reliability of that data and, of course, the skill of the modeler.” *Id.*

For computer modeling purposes, the size of the alleged groundwater plumes migrating from individual sources was determined in large part by the alleged CVOC concentrations in the groundwater at the source, referred to as “source loadings” that are fed into the computer model. Typically, the higher the source loading, the larger the plume. While the City’s allocation expert, Dr.

Olsen with the firm of Camp, Dresser and McKee, testified that it is important to be consistent when modeling the plume size migrating from each source, the Trustees argued that the City's experts were inconsistent in three key respects. First, while the City's experts used only the highest CVOC loadings to model the plume allegedly migrating from the source attributed to the Trustees, 1001 E. Lincoln, they rejected using the highest CVOC loadings when modeling the plumes from upgradient sources. Second, while it is well established that perchloroethylene (PCE) degrades to trichloroethylene (TCE), which degrades to the daughter products dichloroethylene (DCE) which in turn degrades to the daughter product vinyl chloride (VC), the City's experts modeled the daughter products only for the two remaining defendants. The City modeled only the parent products PCE and TCE for the upgradient settled parties. This approach shortened the upgradient plumes and lengthened the plumes attributed to the two remaining defendants.

Further, each of the CVOCs has different cleanup levels at the Site, and the City's experts used the cleanup level for one CVOC, referred to as a surrogate, to define the extent of another CVOC's plume. For example, when modeling the size of the alleged DCE plume migrating from 1001 E. Lincoln, the City's expert modeled the extent of the DCE plume using the alternate cleanup level (ACL) for VC, 2 parts per billion (ppb), instead of the ACL for DCE, 70 ppb. Using a lower cleanup level to define the plume gave the impression that the plume's size and length was larger than in reality (i.e., a plume defined by a 70 ppb boundary is much smaller than a plume that stretches all the way out to a 2 ppb boundary).

These modeling manipulations falsely shortened the upgradient plumes so that they did not appreciably overlap the plumes migrating from the properties formerly owned by the two largest remaining defendants.

The Court rejected the City's approach: "The City's groundwater modeling expert, Michael Smith acknowledged that never before in his professional career had he modeled a parent product using the ACL for a daughter or surrogate product. He had never seen any literature which approved the use of a surrogate. Smith admitted that if he had modeled DCE using the corresponding ACL line for DCE, the resulting simulated plume would have been 'considerably smaller.' In contrast to what appears to be a shortcut by Smith, when ALT's expert [Dr. Edward McBean of Conestoga-Rovers & Assoc.] wanted to know the plume sizes for parent and daughter products, he modeled them both. Had Smith done something similar, his work might have retained more credibility. Finally, Smith and Olsen knew that allocation modeling was for use in this case. In other words, they knew the rules of the game. Smith's failure to follow the rules by not disclosing his change from usual modeling methodology cannot be seen as an innocent mistake. This damaged not only Smith's, but Olsen's, credibility, too." *Id.* at 1109-1110.

Ultimately, the Court rejected the City's contaminant plume modeling methodology based on Federal Rules of Evidence 702(2) and (3), and the *Daubert* line of cases.¹¹ "To be reliable, the expert's testimony must be based on the 'methods and procedures of science' and reflect more than the witness' 'subjective belief or unsupported speculation.' The Court must assess whether the reasoning or methodology underlying the testimony is scientifically valid and whether the reasoning or methodology properly can be applied to the facts in issue. A determination of reliability requires consideration of the flexible, non-exclusive and now-famous *Daubert* factors: (1) whether the theory or technique can be or has been tested; (2) whether the theory or technique has been subjected to peer review or publication; (3) whether there is a potential or known rate of error for the theory or technique; and (4) whether the theory or technique is accepted in the scientific community." *Id.* at 1108.

The Court then examined various glaring errors in the City's modeling. One example was the City's modeling of contamination from their own upgradient source, the City's Bus Barn. The City's expert modeled the direction of the Bus Barn plume contrary to the groundwater flow direction and the plume orientation of every other party's plume in the vicinity. In the City's modeling, the Bus Barn plume flows from northeast to southwest, despite the fact that the City's groundwater monitoring report showed the groundwater flowing from north to south. The Court ruled that "this had the effect of quickly driving the City's plume outside the known boundaries of the actual plumes, a substantial portion of the City's pollution plume was truncated and thus ignored." *Id.* at 1111. This approach

decreased the size of the Bus Barn plume, and directed it away from the plume attributed to the Defendants. In Dr. McBean's modeling, the Bus Barn plume tracks underneath 1001 E. Lincoln. The City took other liberties with the modeling as well: "The City's modeling expert also did not always 'truncate' areas where the model showed contamination but the field data did not. He acknowledged, for example, that his model at APCO was not consistent with reality because it modeled contamination north or upgradient of APCO which was not confirmed by field data. Yet he did not truncate that area. The effect of this use of 'professional judgment' was to allocate contamination to APCO which APCO could not have caused." *Id.* at 1109.

The Court noted that Smith "conceded that his modeling techniques and methodology are not based on any specific guidelines or standards, but rather on his 'professional judgment.'" *Id.* at 1108. The Court then found that his judgment should be accorded little weight.¹²

One of the most important aspects of both parties' allocation scheme was the principle that areas of plumes which overlap should be divided equally between the parties. By shortening the plumes from upgradient sources, the City found that only one plume from an upgradient source overlapped the plume allegedly migrating from 1001 E. Lincoln, and only a portion of 1001 E. Lincoln's plume at that. By contrast, to determine the number of overlaps, the Trustees' groundwater modeling expert, Dr. Edward McBean, modeled both the parent products PCE and TCE as well as the daughter products DCE and VC for all sources in Plume B. Next, he corrected the flow of CVOC plumes to make them consistent with groundwater flow direction. Using the same computer model used by the City's expert, coupled with the CHAIN model, Dr. McBean determined that there were actually four (4) plumes overlapping the plume allegedly migrating from 1001 E. Lincoln (rather than one as alleged by the City), and that each overlapped the entire alleged 1001 E. Lincoln plume. In accordance with the principles expressed by the City's experts, Dr. McBean divided the area attributed to 1001 E. Lincoln by a factor of five (5).

The Court's ruling has a number of important ramifications. First, groundwater modeling, which has been used for several decades in developing remedial actions, is now a viable tool for apportioning damages even when the plumes are commingled. This should provide defendants in contribution actions with a viable defense to joint and several liability. Second, the Court will scrutinize groundwater modeling to assure that it meets the *Daubert* principles. There will be fertile ground for argument on this issue. Despite being used for years in CERCLA's remedial investigation, feasibility study and remedial design phases, the use of such modeling has received relatively little judicial scrutiny. Modeling often appears to be more of an art than a science. In the *City of Wichita* case, both parties used the same computer model; yet the parties, by changing the variables in the computer program, derived vastly different results. There are a number of other groundwater contaminant transport computer models. No doubt, in the future, parties will use competing computer programs, yielding even more divergent portrayals of contaminant fate and transport, and ultimately allocation.

2.2 Attributing the Unmodeled Areas

In the second step of the parties' proposed allocation models, the area attributed to each of the defendants, settling and non-settling, was proportionately increased through a mathematical computation in order to encompass the "unmodeled areas" of contamination. Again, the Trustees adopted this approach to make an apples-to-apples comparison. "Unmodeled areas" are those areas that are contaminated above the ACLs, but which the City did not attribute to any known source. The unmodeled areas cover approximately 20% of the Site.

The City allocated the unmodeled areas to defendants regardless of where the unmodeled areas were located. Upgradient areas of contamination that were not contiguous with a defendant's plume were, nonetheless, allocated to that defendant. APCO's former property at 1001 E. Lincoln is one of the most downgradient sources, and its plume is either "separate and distinct" or "downgradient" from almost every other plume, unmodeled area or orphan share. Based on the fact that it is impossible for alleged contamination from 1001 E. Lincoln to migrate into these unmodeled areas, as well as relevant case law,¹³ the Trustees' expert declined to allocate the Trustees liability for these unmodeled areas.

For the unmodeled areas adjacent to the plume allegedly migrating from 1001 E. Lincoln in some of the Trustees' models, the Trustees allocated half of the unmodeled areas to the City because the City owned sewers and properties in these areas and issued releases to owners of properties in these areas.

Ultimately, the Court selected a computer model proposed by the Trustees' expert which established that there were no unmodeled areas next to the plume allegedly migrating from 1001 E. Lincoln because the groundwater contamination in such areas was attributable to known upgradient sources.

2.3 Allocating the Orphan Shares

In the third step of the City's allocation scheme, after increasing all defendants' shares to encompass the unmodeled areas, the non-settling defendants were also allocated all of the "orphan shares," geographical plume areas for sources where the owner or operator at the time of disposal is allegedly either unknown, or known but deemed by the City to be defunct or insolvent. Ten of the 25 named defendants were designated orphans by the City. The orphan share totaled approximately 20% of the modeled areas in the Site.

Under the City's allocation scheme, the orphan share was borne entirely by the non-settling defendants remaining at trial instead of being distributed between all viable parties, settlors and non-settlors alike. As the City settled with a defendant, the City's experts retired from further allocation to non-settlors the geographical region of contamination associated with that defendant as well as the unmodeled area allocated to that defendant. However, orphan shares were never retired. Instead, Dr. Olsen reallocated the orphan share which previously had been tacked onto the settlor's share to the remaining non-settling defendants. The orphan shares re-allocated to the remaining defendants also included unmodeled areas tacked onto those orphan shares. As a result of the City's allocation approach, non-settling defendants faced an ever-increasing risk of having to pay a larger allocation share the longer they refused to settle and remained in the case.

The Trustees' expert, Mr. Frank Rovers, testified that orphan shares should be allocated to all parties, including the City, not just the non-settling defendants being tried. The Trustees argued that under the Uniform Contribution Fault Act ("UCFA"),¹⁴ and related case law,¹⁵ orphan shares attributed to defunct or insolvent companies should be allocated to all parties (including the City), not just non-settling defendants remaining in the litigation. The Trustees argued that the Court is required under UCFA to reduce the Trustees' share of the liability by the amount of the settling parties' equitable share of liability. They argued that the Court may not re-allocate the settling defendants' orphan share to the non-settling defendants, because it would effectively hang the non-settlors "out to dry", contravening established Tenth Circuit case law.¹⁶

The *Apco* Court ultimately decided not to allocate any orphan shares to the remaining defendants. In reaching this decision, the Court relied primarily upon its equitable authority under CERCLA §113. The Court's decision was based largely upon the City's acceptance of liability under its Certificate and Release ("CAR") program, the City's failure to adequately investigate contamination at property owned or operated by CAR recipients, the City's failure to identify all contaminant sources within the Site, the Trustees' efforts to cooperate with government agencies, and the City's delay in conducting source control at 1001 E. Lincoln. These elements of the Court's decision have a number of implications for urban Brownfield redevelopment projects.

2.3.1 The City's Acceptance of Liability Under the Certificate and Release Program

To encourage the Site's economic development, the City instituted a novel program where it would release from CERCLA liability those property owners who demonstrated that they had not contributed to the contamination.

The Trustees successfully argued that the City assumed liability for CAR recipients because the City had done an inadequate job investigating the sources that were released. Hundreds of businesses operate at the Site, and the Trustees' expert Bruce Clegg testified that many conduct, or conducted, operations involving hazardous substances that may have affected the Site's groundwater. These include gas stations, dry cleaners, auto body shops, airplane parts manufacturers, printing companies,

and a host of other types of industrial concerns. Indeed, in this respect, the City of Wichita is not different from any other medium to large urban city in the United States.

Among these actual and potential sources within the Site are a number of properties where parties were given releases by the City through its CAR program. For example, the Trustees expert testified that the City released, among other sources, an automotive repair facility where solvent odor was detected in an excavation, an automotive facility containing a parts washer, a dry cleaner where dichloroethene was detected in the groundwater and petroleum hydrocarbons were found in the soil, and a property containing paint thinners and cleaning solvents. The City issued a CAR for one property on the very same day that two 500-gallon underground storage tanks used for “dry cleaning solvents” were removed from its property. Documentation in the City’s possession stated “that significant soil contamination was encountered during the excavation of the solvent tanks at this facility.” Additionally, KDHE noted that “it became evident by the odors that we are very likely dealing with a chlorinated solvent.”

The Court observed that “this Site involves over 8,000 parcels of land, and the Court is not remotely convinced that the City has identified all sources of chlorinated solvent releases. The City voluntarily undertook this cleanup, and should have been aware of the Herculean effort required to identify PRPs.” *Id.* at 1105-1106. The Court held that “While a review of [CAR application files] provided by ALT indicates that some of them appeared adequately investigated, other applicants indicated that solvents and similar pollutants were actively used on their property. ALT’s expert testified that he could find no evidence that the City had performed any sampling on many of these properties, and the City made no effort to rebut that claim.” *Id.* at 1105. The Court held that “[t]he City compounded its financial risk when it decided to start issuing formal releases to potential polluters. Issuing those releases with only cursory investigations raises the risk even more. Accordingly, the Court finds that this factor weighs in favor of limiting defendants’ liability for orphan shares.” *Id.*

This aspect of the Court’s ruling has particularly significant implications for municipalities conducting Brownfield projects, and indeed any other party that seeks to recover their response costs through litigation. The burden of identifying defendants clearly falls on the plaintiff, and not the defendants. Should the plaintiff fail to adequately investigate a potential source of contamination, the plaintiff, in essence, assumes that liability. This will mostly like be a very heavy burden in almost any urban or multi-contaminant source setting.

2.3.2 Cooperation With KDHE

The next factor weighted heavily by Court in declining to allocate orphan shares to the remaining defendants was the Trustees’ continuous offers to perform source control measures at 1001 E. Lincoln, and KDHE’s summary rejection of those efforts. KDHE invited the remaining defendants to conduct source control measures at their respective sites. The Trustees responded with an initial proposal for conducting source control provided that they received some form of contribution protection from KDHE. KDHE rejected the proposal and identified several technical deficiencies in the Trustees’ proposal that had to be addressed. In a final letter, the Trustees capitulated on these issues. KDHE never responded to the final letter. “Indeed, according to KDHE attorney Erika Bessey, she barely read past the first page of the letter, after which she ‘got real annoyed and threw it in a pile,’ never bothering to look at it again. Moreover, Bessey noted that even if she had read the letter, she would not have been willing to reach an agreement with ALT - an agreement which she had initially invited, even though ALT was agreeable to everything the KDHE had previously requested. The Court finds Bessey’s conduct was counterproductive to the KDHE’s obligations to oversee environmental protection in Kansas.” *Id.* at 1103. The Court reasoned that “there is something to be said for allowing the party who pays the bill to be involved in selecting the solution, especially where the KDHE has already invited it to do so. Here, the City appears to want to dictate source control measures at the APCO site, while passing the costs on to the Trustees. ALT offered to perform its own source control measures while still remaining accountable to the KDHE for doing a satisfactory job. In doing so, ALT would have been able to better control its own costs while still being obligated to perform the cleanup according to KDHE standards.” *Id.* at 1103-1104. “The Court was also very troubled by the KDHE’s

irresponsible rejection of ALT's source control proposals with no apparent effort to reach a solution." *Id.* at 1104.

Finally, the Court held that the City's own lack of diligence in pursuing remediation of 1001 E. Lincoln was grounds for denying the City's argument that orphan shares should be allocated to the Trustees: "there is evidence that shows the City's own dilatory conduct with regard to source control may have exacerbated the groundwater pollution problem. As early as 1996, the KDHE was harping on the City to pursue source control; yet, to this day the only source control efforts undertaken at the Site were conducted at one of the Coleman facilities and the City's Bus Barn." *Id.* at 1103. "The City has characterized APCO and Reid as two of the 'largest sources of CVOC groundwater contamination at the Site,' yet no effort to control the sources at those sites has been performed. Thus, as a result of the City's delays at source control, chlorinated solvents have had an additional seven years to enter the aquifer and aggravate the groundwater contamination problem. ALT offered to perform source control, and was turned down. The City was asked to do it, but has failed to comply." *Id.*

The implications of this aspect of the Court's ruling are clear. A defendant's efforts to cooperate with the government could substantially reduce its allocated share. Conversely, a party that delays implication of a remedy so that contamination continues to migrate will, itself, be saddled with additional liability.

3. CONCLUSION

The "Wichita Model" has long been touted as a premier model for other municipalities conducting Brownfields redevelopment. The City's use of Tax Increment Financing to pay for environmental remediation is an innovative method for spreading the environmental costs among property tax payers that has been copied many times. Seeking to recover those costs from PRPs, however, is another matter. The Court's ruling places the burden of identifying all PRPs on the party bringing the Section 113 action. Numerous evidentiary issues, equitable considerations, scientific uncertainty and practical impediments could leave a municipality, or indeed any plaintiff saddled with the orphan shares that are often so prevalent in urban settings. Further, municipalities that release landowners from liability should be prepared to accept that liability unless they can show that they thoroughly evaluated the released property. This will be a difficult burden in urban settings where land use history is often complex, and contaminant migration is difficult to determine. Municipalities will also have to take prompt steps to remediate contaminant sources or risk being saddled with orphan share liability.

The Court's ruling has also paved the way for using computer modeling to distinguish between overlapping plumes comprised of the same constituents. While there no doubt will be significant disagreement about modeling techniques and results, this approach will yield a far fairer allocation than the principle of joint and several liability.

NOTES

¹ Unless noted as an implication of the ruling, most, if not all facts and holding are derived from the holding or documents filed by the parties in court.

² The case was a massive undertaking, involving hundreds of witnesses and depositions, and over 750,000 pages of documentary evidence. All exhibits were recorded on multiple computer databases for retrieval during discovery and trial. Nearly all exhibits tendered at trial were presented electronically. They were also hyper-linked when referenced in electronically filed post-trial briefs.

³ The Court also found that Reid Supply, the other remaining defendant, who agreed to accept the Trustees' allocation model, was liable for 0.16% of site cleanup costs. Reid Supply was also located in the downgradient portion Plume B.

⁴ Unlike the City which presented two allocation schemes, the Trustees' expert, Frank Rovers, of Conestoga Rovers & Associates, evaluated six (6) allocation models and ultimately selected portions

of them in proposing the most reasonable allocation model, if any liability was imposed on the Trustees. The six allocation models included the model proposed by the City, a model using the same scheme proposed by the City except that orphan shares were allocated to all parties and unmodeled areas were allocated to just contiguous plumes, two models that followed the above approach but used different source loadings at 1001 E. Lincoln, and a model based upon the number of wells used to remediate the plume migrating from 1001 E. Lincoln. The Trustees used the multiple models to find fairness through common results and reject outlying allocation schemes. The Court ultimately selected one of the Trustees' allocation models and the City's model. All of Mr. Rover's allocation models accepted the City's cost figures, and allocated all such costs. The Court selected a figure from the "Trustees Allocation Model 2", which modified the City's allocation model in two important respects: (1) groundwater modeling and (2) allocation of orphan shares.

⁵ The Court observed that "the settlement figures make clear that the City has, on occasion, done very well for itself." *Id.* at 1104 For example, while the City's own estimates show that one party was only responsible for \$196,002 in past costs, the City reaped \$1.2 million from this party, giving the City a substantial windfall to cover orphan shares. *Id.* The City also settled with a solvent product transporter for \$225,000, but did not account for the transporter's contribution when it allocated response costs to defendants in this lawsuit. This had the effect of making the transporter's settlement appear as another windfall. *Id.*

"Finally, the Court also discovered that the City also received \$200,000 in exchange for indemnifying a former owner of the City's Bus Barn property against environmental liability, yet failed to include this figure in its accounting for past settlements, thereby providing yet another opportunity for double recovery through the remaining defendants. Although the Bus Barn agreement was an indemnification for environmental liability, rather than a formal settlement agreement with a PRP, the Court sees little substantive difference between the two under these particular facts." *Id.* at 1104-1105. In considering these facts, the Court noted that the City suffered shortfalls in some of its settlements. "Nonetheless, the City was in control of its own destiny when it agreed to those numbers. Taking all these facts into consideration, the Court finds that this factor also weighs in favor of limiting defendants' liability for any orphan shares." *Id.* at 1105.

The implication of this aspect of the Court's ruling, is that a municipality, like almost every other plaintiff in a civil action, bears the burden that it settled for too little money

⁶ The Trustees advanced a number of arguments that they should be allocated little or no response costs at the G&M Site: (1) the remedy was not necessary; (2) the costs of response did not comply with the City's contract procurement requirements; the remedy was not consistent with the NCP; the City's data was neither accurate, precise nor reliable; (5) APCO's operations did not cause CVOCs to leach to groundwater at levels exceeding ACLs; (6) the Trustees' cooperation with KDHE; (7) the City's failure to determine when a release occurred at 1001 E. Lincoln; (8) the City's assumption of liability through the COR Program; (9) the City's receipt of an economic benefit from the remediation which spurred development within the Site; (10) the City's delay in remediating its own property; (11) the City voluntarily agreed to cleanup the G&M Site even though it had no legal obligation to do so; (12) the City obtained a significant tax benefit and economic benefit from accepting the responsibility; (13) the City failed to follow its own ordinances with regard to estimating costs and competitive bidding; (14) its remediation of the Bus Barn was incomplete and left significant contamination on that property; and (15) the City allowed its sewer to leak CVOCs. While the Court declined to award no damages to the City, it used a number of these factors in declining to saddle the Trustees with any orphan share.

⁷ The divisibility analysis in a CERCLA § 107 and 113 actions occur at different stages. In a cost recovery action brought pursuant CERCLA § 107, most Courts allow defendants the opportunity to establish divisibility during the liability stage because liability in a section 107 cost recovery action is joint and several. In a CERCLA § 113 contribution action, Courts have determined that the divisibility "defense" is not applicable at the liability stage since defendant's liability is only several. Thus, defendants must prove one of the defenses set forth in CERCLA § 107(b) to avoid

liability in a CERCLA § 113 contribution action. Nevertheless, because CERCLA § 113 permits Courts to evaluate all equitable factors it deems appropriate to allocate response costs, divisibility criteria are evaluated during the allocation stage in a contribution action. *See Akzo Coatings, Inc. v. Aigner Corp.*, 909 F. Supp. 1154, 1161 (N.D.Ind. 1995) (“Causation, while irrelevant when determining liability, can affect the ultimate determination of damages under § 113(f).”) and *U.S. v. Alcan Aluminum* (964 F.2d 252, 270 (3rd Cir. 1992) (“In a sense, the ‘contribution’ inquiry involves an analysis similar to the ‘divisibility’ inquiry, as both focus on what harm the defendant caused.”)

⁸ Unlike the Gore factors, which were specifically designed to equitably apportion liability, the divisibility doctrine is based in the principles of causation.

⁹ Geographical division can also occur where different media, such as soil and groundwater, are contaminated. *Memphis Zane May Associates v. IBC Manufacturing Company*, 952 F. Supp. 541, 548 (W.D. Tenn. 1996).

¹⁰ *See e.g., United States v. Vertac Chem Corp.*, 79 F. Supp. 2d 1034 at 1037-38 (E.D. Ark. 1999) (rejecting contribution defendants’ attempt to divide site into “mini-sites” because wastes had commingled); *Raytheon Constructors, Inc. v. ASARCO, Inc.* 2000 WL 1635482 at *11 n.1 (D. Colo. March 31, 2000), (“a defendant can secure apportionment of response costs and escape joint and several liability only if it can demonstrate that the harm it caused is divisible, a nearly impossible burden.”); *Centerior Service Co. v. Acme Scrap Iron & Metal Corp.*, 153 F.3d 344, 348 (6th Cir. 1998) (“Given the nature of hazardous waste disposal, rarely if ever will a PRP be able to demonstrate divisibility of harm, and therefore, joint and several liability is the norm.”); *Axel Johnson, Inc. v. Carroll Carolina Oil Co.*, 191 F. 3d 409, 417-418 (4th Cir. 1999) (rejecting plaintiffs argument that property could be divided into multiple facilities because contamination existed throughout the facility); *Northwestern Mutual Life Insurance v. Atlantic Richfield Corp.*, 847 F. Supp. 389, 401 (E.D. Va. 1994) (imposing joint and several liability on defendant despite multiple sources of hazardous substances, because the Court found it impossible to separate out the harms caused by the different units). The rule in *Apco* departed significantly from these line of cases.

¹¹ *Daubert v. Merrell Dow Pharmaceutical, Inc.*, 509 U.S. 579, 113 S. Ct. 2786 (1993).

¹² The Court was highly critical of Mr. Smith. "In countless opinions, courts have observed that an overriding purpose of expert testimony is helpfulness to the trier of fact. The vast majority of these opinions analyze a judge’s decision to admit or exclude expert testimony offered in a jury trial. In this court trial, the written transcript does not adequately reflect the difficulties with the presentation of Smith’s unnecessarily long, complex and confusing testimony. Both Smith and his presenting counsel were admonished that the court was having a great difficulty understanding Smith’s testimony. The admonitions went unheeded. Eventually, the problem became so bad that the court threatened Smith with contempt and restricted him to “yes or no” answers on cross-examination, a step which was not necessary with any of the other witnesses, many of whom were experts. In the end, Smith’s testimony did little to help the court reach a decision in this difficult case. Accordingly, Smith’s testimony and his modeling work accorded little weight."

¹³ In *U.S. v. Broderick*, the Court held that the defendant was not liable for a contaminant plume that had neither merged with the plume on its land nor migrated onto its parcel of land. 862 F. Supp., 272, 276 (D.Colo. 1994). (In *United States v. Broderick Inv. Co.*, 955 F. Supp. 1268 (D.Colo.1997) (“Broderick II”) *af’d in part, rev’d in part U.S. v. Burlington Northern R. Co.*, 200 F.3d 679 (10th Cir. 1999) (affirmed apportionment of damages based on divisibility), the District Court ruled that the damages that were recoverable from defendant should be reduced proportionally according to the District Court’s geographic divisibility ruling in *Broderick I*. Thus, defendant’s liability was reduced by the portion of other defendants’ settlement geographically attributable to the area of the Site for which defendant was jointly and severally liable with the other defendants under the District Court’s prior holding.) In reaching its decision, the Court, relying on the Restatement (Second) Torts § 433A, reasoned that “where two or more joint tortfeasors act independently and cause a distinct or single harm for which there is a reasonable basis for division according to the contribution of each, then each is liable only for damages for its

own portion of the harm.” 862 F. Supp. at 276. The Court also noted that the Tenth Circuit, in a related case, distinguished between the two plumes as well for the purposes of insurance coverage. *Broderick Investment Co. v. Hartford Acc. & Indm. Co.*, 954 F.2d 601 (10th Cir. 1992).

In *U.S. v. Hercules*, the Eighth Circuit held that a site may be divisible if a defendant can establish that it consists of “non-contiguous” areas of contamination. 247 F.3d 706, 717-719 (8th Cir. 2001). The Court noted that defendants may be able to demonstrate distinct harms for divisibility based on geographical considerations, such as where a site consists of non-contiguous areas of contamination or separate and distinct plumes of groundwater contamination 247 F.3d at 719 (citing *Akzo Coatings, Inc. v. Aigner Corp.*, 881 F. Supp. 1202, 1210-1211 (N.D. Ind. 1994), *clarified on reconsid.*, 909 F. Supp. 1154 (N.D. Ind. 1995) (Granting defendants’ motion for summary judgment on the issue of joint and several liability because the contaminated sites were non-contiguous citing *Broderick*, 862 F. Supp. at 277). *See also FMC Corp. v. Vendo Co.*, 196 F.Supp.2d 1023, 1034 (E.D.Cal. 2002) (“Separate and distinct subterranean plumes of groundwater contamination provide a basis to divide CERCLA liability for a site.”); *Memphis Zane May Associates v. IBC Mfg. Co.*, 952 F.Supp. 541, 549 (W.D.Tenn. 1996) (Defendant can avoid joint and several liability by showing that hazardous substances occupy separate and distinct geographic areas of contamination.).

¹⁴ Pursuant to the Uniform Comparative Fault Act of 1977 (“UCFA”), 12 U.L.A. 42, the Trustees argued that orphan shares should be attributed to all viable defendants, not just the remaining non-settling defendants.

UCFA creates a right to contribution between two or more persons who are jointly and severally liable for the same injury based upon the parties respective, proportionate, equitable share. UCFA § 4(a), UCFA § 2. The total fault is to be allocated among each claimant, defendant, third party defendant, and person who has been released from liability by agreement. UCFA § 2(a). UCFA specifically provides for insolvent parties’ shares to be allocated among solvent parties, including the plaintiff, according to their respective proportions of fault. UCFA § 2(d). UCFA requires that the liability of non-settling private parties is reduced by the amount of the settling private parties’ equitable share of liability, rather than by the actual dollar amounts of settlements.

In *Barton Solvents v. Southwest Petro-Chem, Inc.*, the Court held that the non-settling defendants’ share of liability is not increased by settlements under the proportionate credit rule. 834 F. Supp. 342, 346 (D. Kan. 1993). UCFA protects “non-settling defendants by assuring that their liability will reflect only their responsibility for the cleanup costs.” *Id.* at 348 (quoting *Edward Hines Lumber Co. v. Vulcan Materials Co.*, 1987 WL 27368, at *2 (N.D. Ill. 1987)). Additionally, the Court recognized that “UCFA does not ‘hang the non-settling defendants out to dry’ since the settling plaintiff bears the risk that the settling defendant’s proportionate share of the clean-up costs may be greater than the settlement amount.” *Id.* (quoting *Lyncott Corp. v. Chemical Waste Management, Inc.*, 690 F. Supp. 1409, 1418 (E.D. Pa. 1988)).

¹⁵ *United States v. Atlas Minerals and Chemicals, Inc.*, 1995 U.S. Dist. LEXIS 13097 at *234-237 (E.D. Penn. 1995) (Third-party defendants’ allocation will be reduced by the equitable shares of those third-party defendants which have settled, following UCFA); *Hillsborough County v. A & E Road Oiling Service, Inc.*, 853 F. Supp. 1402, 1410 (M.D. Fl. 1994) (“UCFA effectively embraces both prompt clean-up and fair allocation.”); *United States v. SCA Services of Indiana*, 827 F. Supp. 526, 536 (N.D. Ind. 1993) (UCFA secures equitable apportionment of liability for nonsettlers); *American Cyanamid Co. v. King Industries, Inc.*, 814 F. Supp. 215, 219 (D.R.I. 1993) (adopting UCFA and holding that plaintiffs’ remaining claims shall be reduced by the amount of each settling parties’ equitable share of liability, if any, as equitable shares are determined at trial); *Comerica Bank—Detroit v. Allen Indus., Inc.*, 769 F. Supp. 1408, 1414 (E.D. Mich. 1991) (UCFA “does not...hang the non-settling defendants out to dry...”); *Allied Corp. v. Acme Solvent Reclaiming, Inc.*, 771 F. Supp. 219, 223 (N.D. Ill. 1990) (“UCFA protects non-settling defendants by assuring them that they will not be liable for more than their equitable share as finally determined at the close of litigation.”); *U.S. v. Western*

Processing Company, 756 F. Supp. 1424, 1432 (W.D. Wash. 1990) (under UCFA, it is not equitable to require non-settlers to absorb orphan share liability as a result of settlements); *United*

States v. Laskin, 1989 U.S. Dist. LEXIS 4900 at * 18 (N.D. Oh. 1989) (Applying UCFA, “the government’s claim against any non-settling defendant shall be reduced by the greater of the amount of the settling defendants’ combined equitable share of the obligation or the amount of the settlement.”); *Edward Hines Lumber Co. v. Vulcan Materials Co.*, 1987 WL 27368 at *2 (N.D.Ill. 1987) (UCFA “protects non-settling defendants by assuring that their liability will reflect only their responsibility for the clean-up costs, regardless of the amount the settling defendant tendered to the plaintiff.”); *Lyncott Corp. v. Chemical Waste Management Inc.*, 690 F. Supp. 1409, 1418-19 (E.D. Pa. 1988) (UCFA “avoids the inequity that might develop were nonsettlers forced to absorb the total cost responsibility that are not allocable to solvent responsible parties.”).

¹⁶ A number of Circuits have held that it would be unfair to allow innocent PRPs to proceed in a § 107 case and transfer all potential liability to other PRPs because there may be orphan shares of liability that should be equitably divided among the plaintiffs and other defendant PRPs. *Sun Co. v. Browning-Ferris, Inc.*, 124 F.3d 1187, 1193 n.4 (10th Cir. 1997) cert. denied, 118 S.Ct. 1045 (1998); *Morrison Enterprises v. McShares, Inc.*, 302 F.3d 1127, 1135 (10th Cir. 2002). See also, *Pinal Creek*

Group v. Newmont Mining Corp., 188 F.3d 1298, 1303 (9th Cir. 1997) (“Immunizing PRPs who have directly paid for cleanup operations from the risk of sharing the cost associated with orphan shares would undermine the ability of Courts to allocate costs between all PRPs ‘using such equitable factors as the Court determines are appropriate.’”); *Ekotek Site PRP Committee v. Self*, 1 F. Supp. 2d 1282, 1293 (D. Utah 1998) (orphan shares to be allocated among all PRPs); *United States v. Davis*, 31 F. Supp. 2d 45, 62 (D. R.I. 1998) (“Equitable allocation calls for liability to be apportioned among all responsible parties.”); *Browning-Ferris Indus. of Ill., Inc. v. Ter Maat*, 13 F. Supp. 2d 756, 773 (N.D. Il. 1998), rev’d in part, aff’d in part, *Browning-Ferris Indus. of Ill., Inc. v. Ter Maat*, 195 F. 3d 953 (7th Cir. 1999) (reversed on the issue of parent company liability but affirmed on the issue of allocation of responsibility for clean-up costs, stating “[o]rphan shares should be apportioned to the PRPs (both plaintiffs and defendants) according to their relative equitable share.”); *United States v. Kramer*, 953 F. Supp. 592, 598-99 (D. N.J. 1997) (“There is no reason in law or equity to rule out the notion that consideration may be given to equitable apportionment of the “orphan share” among all responsible parties...”); *Charter Township of Oshtemo v. American Cyanamid Co.*, 898 F. Supp. 506, 509 (W.D. Mi. 1995) (“Equity and fairness dictate that the shares that would have been attributed to parties that are now insolvent should be apportioned among all of the solvent PRPs.”).

PART XII: Vapor Intrusion

Chapter 37

VAPOR INTRUSION ATTENUATION FACTORS BASED ON LONG TERM MONITORING DATA

D.J. Folkes, E.J. Wannamaker, and J.P. Kurtz

EnviroGroup Limited, Centennial, CO; Wannamaker now with Gradient Corporation

Abstract: Screening for vapor intrusion potential is likely to be required at a large number of sites in the future, due to federal or state requirements, real estate transactions, or voluntary cleanups. At most sites, the authors expect that only groundwater data will be available in sufficient quantity to conduct initial screening (as opposed to soil vapor or indoor air data). Therefore, groundwater data will tend to drive the need for additional vapor intrusion investigations at most sites. The current EPA subsurface vapor intrusion screening guidance (EPA 2002) assumes that soil vapor concentrations immediately above the water table are at equilibrium with groundwater concentrations (based on Henry's Law Constant) and that indoor air concentrations in overlying buildings are 1000 times lower (an attenuation factor of 1/1000), due to attenuation through the soil column and building shell. According to EPA (2002), attenuation factors based on empirical groundwater and indoor air measurements are less than 1/1000 approximately 95% of the time. Unfortunately, the resultant groundwater screening levels are often at or below federal drinking water standards (MCLs). In most cases however, the empirical data used to develop this attenuation factor were based on measurements of groundwater and indoor air at one point (24 hours) in time. Groundwater and indoor air monitoring at a five houses in Colorado over the past eight years has allowed comparison of attenuation factors based on single points in time and on long-term averages (annual and multi-year), based on 1,1-DCE, which has the advantage of having few confounding indoor sources. These data indicate that single point measurements can significantly over or under estimate long term average attenuation factors. Short-term attenuation factors were observed to vary by up to one order of magnitude over time within the individual homes in this study, and ranged from 10^{-4} to 10^{-6} . Inaccuracies in groundwater concentrations and seasonal variations in ventilation likely explain short term variations in attenuation factor. Vapor intrusion screening levels based on long term mean attenuation factors and groundwater concentrations would provide less conservative screening levels for vapor intrusion.

Key words: vapor intrusion; attenuation factor; long term monitoring; indoor air tests.

1. INTRODUCTION

Vapor intrusion, or the movement of volatile chemicals from the subsurface into overlying buildings (EPA, 2002) has become a recent focus of the U.S. Environmental Protection Agency (EPA) and many state agencies (Eklund et al., 2006). As a result, investigation and mitigation of vapor intrusion may now be required at sites under RCRA, CERCLA, Brownfields, and voluntary cleanup programs (EPA, 2002). Further, the potential for vapor intrusion impacts, either due to on-site sources of contamination or off-site sources, may be pertinent to many Phase 1 environmental site

assessments (e.g., ASTM E-1527) conducted as part of real estate transactions (personal communication with Anthony Buonicore, President, Environmental Data Resources, Inc., September 2006).

1.1 Need for Vapor Intrusion Screening Process

Site specific evaluations of vapor intrusion (e.g., indoor air and sub-slab testing) can be intrusive, costly, and require months or even years to complete (EPA, 2002). Therefore, simple and inexpensive screening procedures are needed to separate sites where further evaluation is warranted from sites where no further action is necessary. The current EPA vapor intrusion guidance (EPA, 2002) provides such a screening step, in the form of generic or “Tier 2” screening tables for groundwater and soil vapor concentrations. The EPA groundwater screening levels are based on target indoor air concentrations for most common volatile chemicals and an “attenuation factor” of 1/1000.

The attenuation factor, α , is equal to the indoor air concentration divided by the soil vapor concentration at the depth of concern (Johnson and Ettinger, 1991). EPA groundwater screening levels assume that soil vapor concentrations immediately above the groundwater table due to partitioning from the groundwater to the vapor phase, will be attenuated by a factor of 1000. Therefore, a soil vapor concentration equal to the indoor air target level multiplied by 1000 (or less) should be acceptable. The acceptable soil vapor concentration is converted to a groundwater concentration or screening level by dividing by the Henry’s Law Constant for the compound (EPA, 2002).² Although EPA is currently revising its vapor intrusion guidance, it does not expect to change the attenuation factor used to calculate groundwater screening levels (1/1000) in the revised guidance (Schuver, 2006). Unfortunately, the attenuation factor of 1/1000 results in groundwater screening levels that are often below or only slightly above MCLs. As a result, the mere presence of a contaminant plume containing dissolved concentrations above the MCL (often the definition of a plume) can be enough to trigger the need for further evaluation.

EPA (2002) attempts to reduce the conservatism of the screening levels by providing a “semi-site specific” or Tier 2a screening step, in which screening levels are adjusted based on depth to groundwater and soil type. The adjustments are based on the Johnson and Ettinger model (EPA, 2004) using conservative default parameters (EPA, 2002). However, groundwater screening levels can, at most, increase by a factor of 10 and then only for the least permeable soil types and depths to groundwater exceeding 10 m. EPA has proposed including a “constrained” version of the Johnson and Ettinger model and exterior soil vapor concentrations in the revised guidance, to replace the semi-site specific step (Schuver, 2006). However, as of the time of writing, the revised guidance has not been published. Further, the model would need to be conservative if based on exterior and limited data (Schuver, 2006), questions regarding the appropriate location and depth of soil vapor samples need to be resolved (e.g., Wertz, 2006), and soil vapor data are not available at many sites for screening purposes.

Therefore, a better approach to screening of sites using limited and non-intrusive data is still required, particularly to facilitate real estate transactions that would be burdened by expensive and prolonged investigations. Because groundwater data is more likely to be available than soil vapor data at sites requiring Phase 1 environmental site assessments, a screening approach using groundwater data is particularly desirable.

1.2 Empirical Basis of EPA Attenuation Factors

The EPA (2002) groundwater screening levels are based, in part, on an attenuation factor of 1/1000. This attenuation factor is, in turn, based on empirical data from a number of sites where indoor air and groundwater concentrations are available (EPA, 2002). These data were screened for data quality and potential background (i.e., indoor or ambient sources) influences, and then the 95th

² EPA (2002) sets the groundwater screening level to the federal safe drinking water MCL if the calculated risk-based value is less than the MCL. In the authors’ experience, states using the EPA guidance may or may not default to the MCL.

percentile of the empirical attenuation factors was selected for screening purposes. In other words, approximately 95% of the real world attenuation factors were less than 1/1000 (i.e., more attenuation occurred); therefore, only approximately 5% of sites with groundwater concentrations equal to the groundwater screening level are expected to exceed the target indoor air concentration.

Subsequent evaluations of additional empirical data by EPA have continued to show that the 1/1000 attenuation factor is conservative; i.e., nearly all real world attenuation factors are lower (Hers, Dawson, and Truesdale, 2006).

1.3 Long Term Attenuation Factors

The empirical attenuation factors used by EPA to develop the 1/1000 attenuation factor for groundwater screening levels are based on indoor air concentrations and groundwater concentrations measured at one point in time; e.g., a 24 hour indoor air sample and an instantaneous groundwater sample (EPA, 2002). It is reasonable to expect that attenuation factors in any individual building will vary over time, due to various factors that affect indoor air and groundwater concentrations separately (e.g., Johnson and Ettinger, 1991; Johnson, 2005). For example, groundwater concentrations and other factors being equal, a short term change in the building air exchange rate would change the indoor air concentration of a chemical present due to vapor intrusion. Therefore, the observed attenuation factor would change, even though the groundwater concentration remained constant.

Because the empirical attenuation factors used by EPA (2002) are based on single data points in time (hereinafter referred to as “single point attenuation factors”), they represent not only the variation between individual buildings and sites, but also the variations over time at individual buildings.

Risk management decisions, such as the need for mitigation, are typically based on estimates of long term risk (e.g., EPA, 1992); therefore, it would also be reasonable to base vapor intrusion screening levels on long term average attenuation factors and groundwater concentrations. By definition, the variance of the long term average attenuation factors will be less than the variance of the underlying population of single point attenuation factors. Therefore, groundwater screening levels based on long term average attenuation factors would be lower and less conservative than the current EPA (2002) screening levels, while still having the same low level of false negatives based on long term risk.

The purpose of this study was to evaluate the variation in attenuation factor over time in homes with both long term indoor air and groundwater monitoring data.

2. METHODS

Long term indoor air and groundwater monitoring has been conducted at a vapor intrusion site in Colorado for over eight years, where 1,1-dichloroethylene (DCE) is the principle compound of concern. Monitored homes include those that were mitigated by installing sub-slab depressurization systems (Folkes and Kurz, 2002), and homes surrounding the area where mitigation was required (verification monitoring homes). Indoor air monitoring has been conducted in verification monitoring homes on a quarterly, semi-annual, or annual basis depending on the location of the home with respect to the plume and the magnitude of concentrations found in adjacent, mitigated homes. Indoor air concentrations of DCE in the verification monitoring homes have remained below the action level (at the time) of 0.49 ug/m^3 , but were often detectable because of the proximity of the homes to the plume and mitigation area. Therefore, in some cases several years of quarterly monitoring data with detectable levels of DCE due to vapor intrusion are available for evaluation.

Groundwater monitoring has also been conducted in shallow wells on a quarterly basis for the past eight years. For the purposes of this study, we selected unmitigated homes where indoor air concentrations of DCE were generally detectable over a period of several years, and where a groundwater monitoring well was located nearby. Further, we narrowed the list to five homes where the geology and plume concentrations were relatively consistent and well understood, so that the selected well was likely to be reasonably representative of conditions in the vicinity of the home.

DCE is a particularly useful compound for studying vapor intrusion because it is seldom found in residential indoor air due to background sources (Kurtz and Folkes, 2002). Therefore, background contributions are unlikely to have contributed to the indoor air concentrations measured in these five homes.

2.1 Indoor Air Sampling and Analysis Methods

Indoor air samples were collected over a nominal 24 hour period in 6 liter Summa canisters equipped with flow regulators. The canisters were placed in the lowest potential living space of each home, away from doors, windows and vents. The canisters were cleaned, tested and certified to be clean to the analytical detection limit (see below) by the laboratory, and evacuated to a near complete vacuum (nominal 30" of mercury at sea level or 0.05 torr) prior to being shipped to the site. The canister pressure was checked by the sampling technician prior to use to ensure that air had not leaked into the canister during shipment. The pressure was checked again at the end of the sampling period and upon receipt by the laboratory to ensure sample integrity during shipment.

The indoor air samples were analyzed in accordance with EPA Toxic Organic Method TO-15 and CDPHE's Guidance for Analysis of Indoor Air Samples (CDPHE, 2000) using a mass spectrometer operated in the selective ion monitoring (SIM) Mode with a reporting limit of 0.04 $\mu\text{g}/\text{m}^3$ for 1,1-DCE. QA/QC samples included trip blanks and field duplicates at the rate of one per twenty samples.

2.2 Groundwater Sampling and Analysis Methods

Groundwater samples were collected from two inch diameter Schedule 40 PVC wells with threaded joints installed in eight inch diameter boreholes advanced by hollow-stem auger drill rigs. The bottom ten feet of the wells were screened with 0.02 inch sized machined slots and graded silica sand added in the annulus of the casing to a height of one to three feet about the top of the screened interval.

The wells were installed so that the static water level at the time of drilling was within the ten foot screened interval; therefore, the upper five to ten feet of the aquifer was typically screened.

Groundwater samples were collected by decanting with minimal agitation into lab-prepared sample vials leaving zero-headspace, after purging three casing volumes. Samples were immediately cooled to 4 degrees C, shipped to the laboratory and analyzed by EPA Method 8260B. QA/QC samples included field duplicates at the rate of one per ten samples and one trip blank per sampling event.

2.3 Calculation of Attenuation Factors

The indoor air and groundwater monitoring programs were designed with different objectives in mind; therefore, indoor air and groundwater samples were not necessarily collected at the same time. Nevertheless, there is no reason to believe that a groundwater sample collected in a well at the same time as an indoor air sample in a house will be representative of the groundwater below the house at that exact time, even when the well is near the house. Therefore, we estimated groundwater concentrations for the purposes of calculating attenuation factors by determining the average groundwater concentration of all samples collected in the well within 90 days before or after indoor air testing, except in two cases where data trends indicated that a particular test result would likely be more representative. If no groundwater sample fell within this time period, the indoor air test result was not used (i.e., an attenuation factor was not calculated). The attenuation factor (at a single point in time) was then calculated by the following equation:

$$\alpha = C_{IA}/(C_{GW} * H')$$

where C_{IA} is the concentration in indoor air, C_{GW} is the concentration in groundwater (compatible units), and H' is the dimensionless Henry's Law Constant for DCE of 1.07 (EPA, 2004).

3. RESULTS

Indoor air concentrations of DCE measured in each of the five homes (H1 through H5) over time ranged from less than 0.04 $\mu\text{g}/\text{m}^3$ to 2.9 $\mu\text{g}/\text{m}^3$, and varied by a factor of approximately 5 to 10 in individual homes (Figure 1). Groundwater concentrations measured over time in nearby monitoring wells (average of all samples collected within 90 days of the indoor air sample date) ranged from 0.34 $\mu\text{g}/\text{l}$ to 480 $\mu\text{g}/\text{l}$, and varied by a factor of approximately 2 at H1 to 20 at H5 (Figure 2). For convenience, wells are identified by the associated house number. Note that the same well is associated with houses H1 and H4, although sample dates and, therefore, average groundwater concentrations vary slightly for some samples.

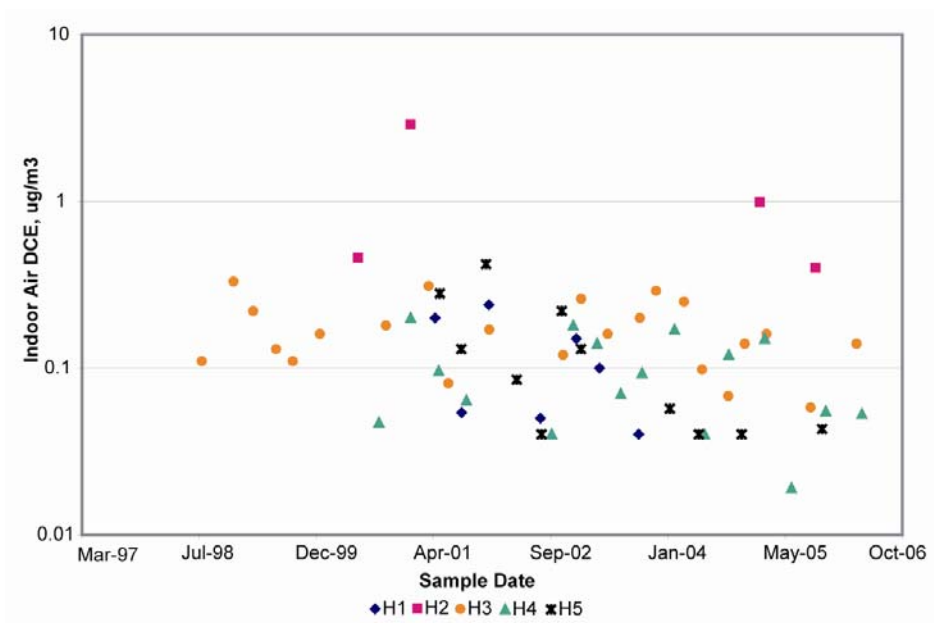

Figure 1. Indoor air concentrations of DCE

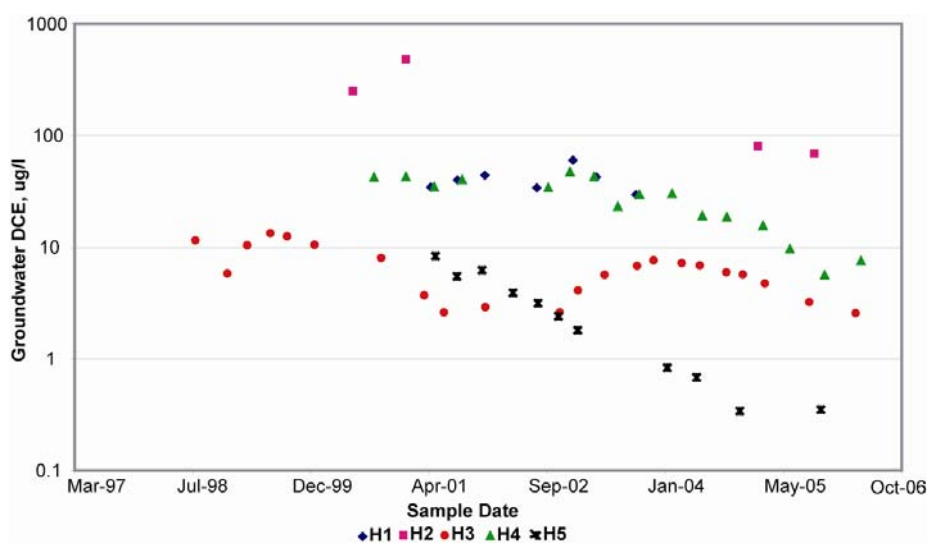

Figure 2. Groundwater concentrations of DCE

Calculated attenuation factors for all indoor air samples collected in all five homes range from approximately 10^{-6} to 10^{-4} , as shown on Figure 3. Attenuation factors are also ranked and plotted as a cumulative percentile distribution on Figure 4. The straight line distribution indicates that the single point attenuation factors are lognormally distributed. Also plotted are the average and geometric mean attenuation factors for each of the five homes.

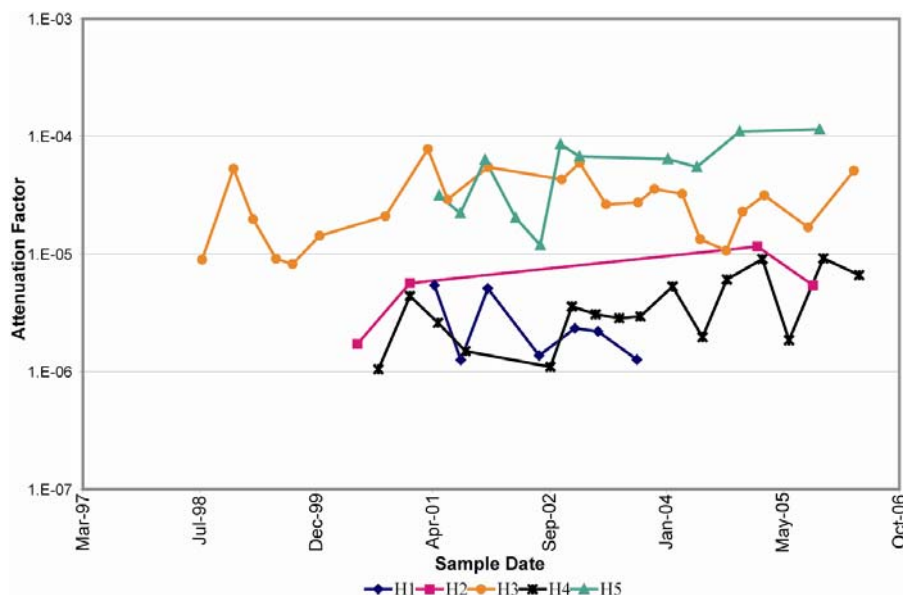

Figure 3. Single point in time attenuation factors

4. DISCUSSION

The results of long term indoor air and groundwater monitoring at the five homes evaluated during this study show that empirical attenuation factors vary over time, typically by one order of magnitude (Figure 3). Therefore, empirical attenuation factors based on single, 24 hour indoor air tests, may over or underestimate the long term average or mean attenuation factor for a given building by up to half an order of magnitude.

Further, populations of single point attenuation factors, such as the database of attenuation factors used by EPA (2002) to develop its screening levels, will exhibit more scatter and broader distributions than the associated population of long term attenuation factors for the same buildings. Using these five homes as an example (albeit small) population of attenuation factors, the single point values vary from approximately 10^{-6} to 10^{-4} (Figure 4), with a 95th percentile of about 8×10^{-5} . However, the maximum geometric mean attenuation factor for any of the five homes is 5×10^{-5} , with a 95th percentile of approximately 4×10^{-5} . Therefore, a screening level based on the 95th percentile of the long term mean attenuation factor (applied to the long term average groundwater concentration) would be less conservative by a factor of 2. A much larger population of long term mean attenuation factors, however, would be required to establish such screening levels.

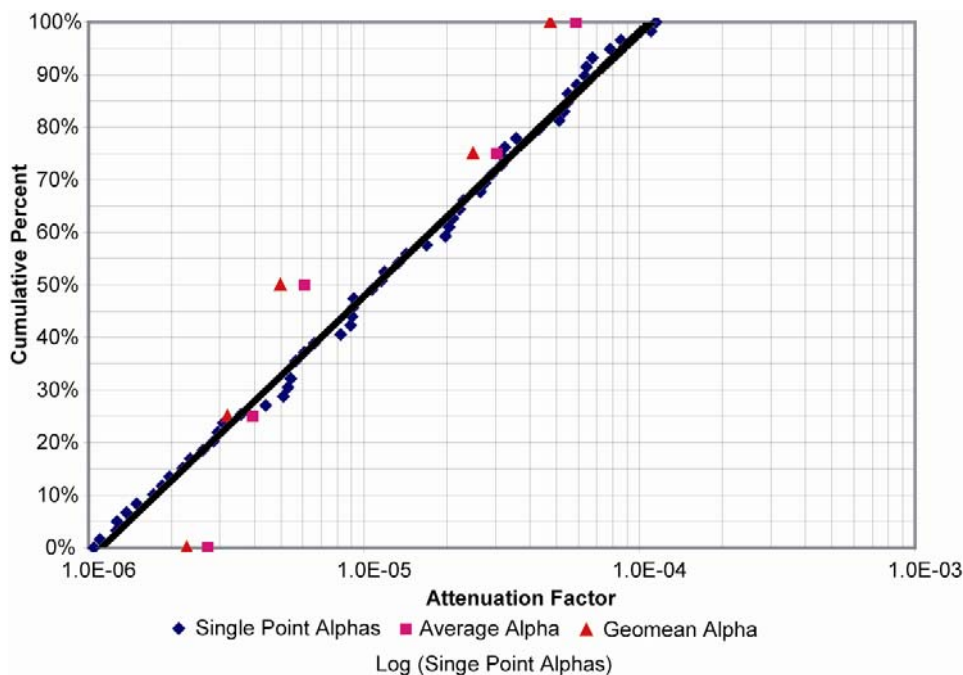

Figure 4. Single point attenuation factor distribution (5 homes)

Attenuation factors may vary over time due to variations in both subsurface and surface (or structural) conditions. For example, variations in depth to groundwater and groundwater temperatures could cause small changes in attenuation factor (EPA, 2004).

Inaccuracy in groundwater concentration estimates, however, could result in relatively large apparent variations in attenuation factor. For example, Figure 5 shows two scenarios where groundwater concentrations measured in a monitoring well upgradient of house (the same illustration would also apply for a downgradient well) vary over time. In the first scenario, the frequency of the fluctuations in concentration and the contaminant velocity result in concentrations below the house that, fortuitously, are similar at any point in time to those in the well. Therefore, the calculated attenuation factor would remain constant, assuming that the indoor air concentration varied in response to the groundwater concentration and no other factors affecting attenuation changed. In the second scenario, the concentration below the house fluctuates in the opposite direction to the concentration in the well; therefore, when the concentration is high in the well, it's low below the house, and vice versa. As a result, the calculated attenuation factor would vary simply because of the error in the groundwater concentration, all else being equal. In other words, although the indoor air concentration would rise due to the actual increase in groundwater concentration below the house, the groundwater concentration in the well would go down, resulting in a larger attenuation factor (less apparent attenuation). Conversely, when the indoor air concentration fell due to an actual decrease in groundwater concentration below the house, the corresponding higher concentration in the well would result in a smaller attenuation factor (more apparent attenuation).

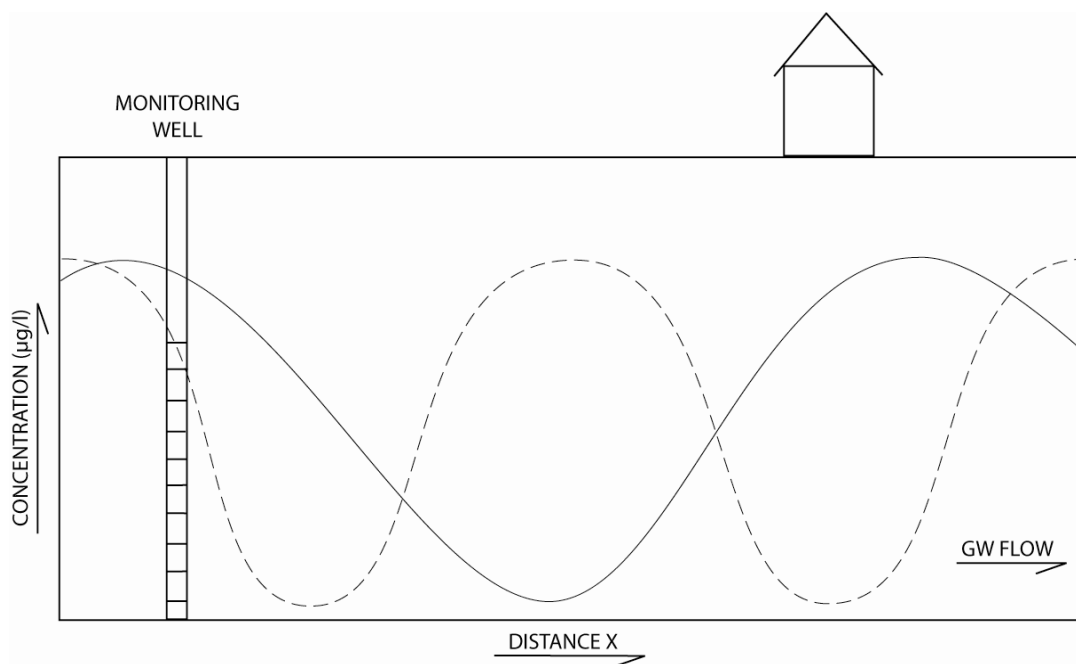

Figure 5. Concentration phase lag between well and house

Similarly, concentrations in wells might underestimate or overestimate concentrations below nearby houses due to long term rising and falling trends. For example, a well located upgradient of a house would indicate lower concentrations than below the house if plume concentrations were falling over time, and larger concentrations if the plume concentrations were rising over time. The magnitude of the error would depend on the rate of the rise in plume concentrations, the rate of plume migration, and the distance to the house.

On the other hand, short term fluctuations in groundwater concentrations might have little to no effect on vapor flux and, therefore, attenuation factor. As shown in Figure 6, short term increases or decreases in groundwater concentration below a house might cause the soil vapor concentration to increase or decrease above the water table as the chemical attempts to re-establish equilibrium concentrations above and below the interface. However, this change in vapor flux boundary conditions would not necessarily cause an immediate change in the soil vapor gradient, depending on how quickly vapors could move through the soil. In fact, for short term fluctuations in groundwater concentrations, the soil vapor gradient and flux rate would likely remain constant, based on the average boundary condition concentration (i.e., the average groundwater concentration over time). The definition of “short term”, however, would be site specific and warrants more research. Therefore, single point attenuation factors based on groundwater concentrations that fluctuate over time might imply a variation in attenuation that does not actually occur (i.e., vapor flux is relatively constant, all other factors being equal).

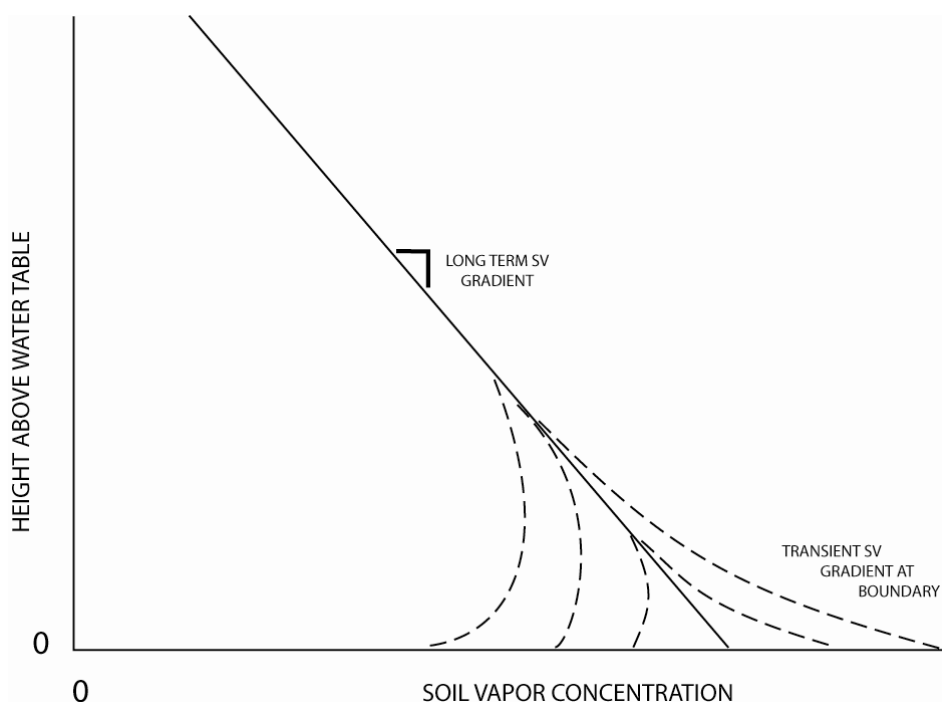

Figure 6. Affect of fluctuations in groundwater concentration on soil vapor gradient

A plot of calculated soil vapor concentrations immediately above the groundwater table, based on groundwater concentrations multiplied by the Henry's Law Constant for DCE and by 1000 to convert from $\mu\text{g}/\text{l}$ to $\mu\text{g}/\text{m}^3$, versus indoor air concentration, is shown on Figure 7 for each of the five houses. The indoor air concentrations show a general correlation with soil vapor (i.e., groundwater) concentrations, but the correlations are very weak. This indicates that a) the groundwater estimates are inaccurate, and/or b) that other factors have greater influence on variations in indoor air concentration. The first premise is likely true to some degree, and is also likely true for empirical attenuation factors at other sites included in the EPA database, unless unusual numbers of wells surrounded each of the houses for which attenuation factors are included. In fact, even if groundwater concentrations below the houses were accurately represented, the phenomenon suggested in Figure 6 may mean that using short term groundwater concentrations to calculate attenuation factors, rather than longer term average values, results in an apparent, rather than a true, attenuation factor.

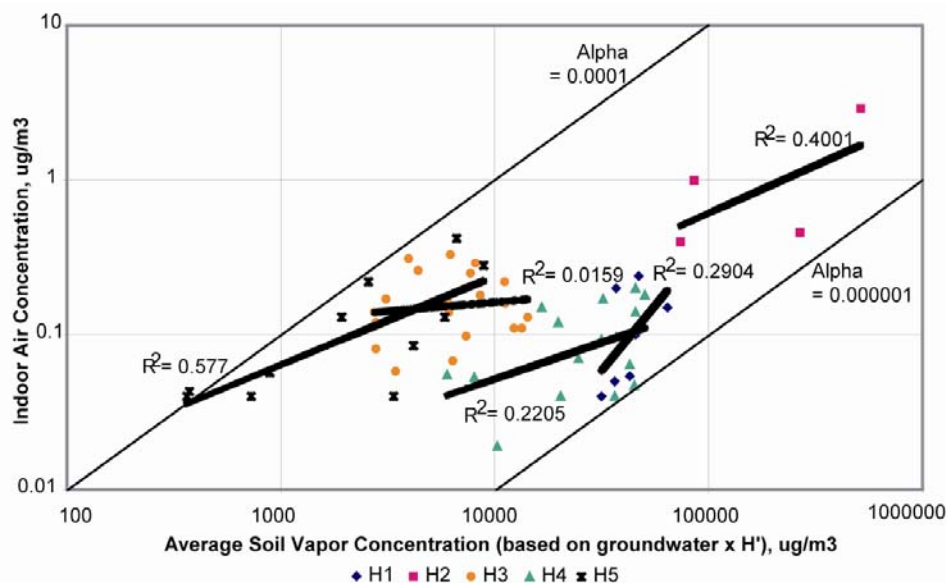

Figure 7. Correlation between indoor air and soil vapor (groundwater derived) concentrations

A plot of normalized attenuation factors (single point attenuation factors divided by the long term mean attenuation factor for each house) versus season shows that variations in attenuation factor correlate to season (Figure 8). Attenuation factors between December and March are above average nearly 90% of the time, meaning that less attenuation occurs during winter months. This behavior is likely due to less air exchange and greater depressurization due to heating in the winter, resulting in higher soil vapor fluxes into the homes and less dilution. Because diffusion is often the rate limiting factor at sites with silty and clayey vadose zone soils (Johnson, 2005), seasonal variations in air exchange rate might be the critical factor affecting variations in attenuation factor over time at these homes.

5. CONCLUSIONS & RECOMMENDATIONS

Groundwater screening levels are needed to screen out sites that do not warrant further evaluation for vapor intrusion, to avoid unnecessary investigations, particularly during real estate transactions. Unfortunately, the current EPA (2002) screening levels are near or below MCLs for many common compounds of concern, including TCE and PCE. Less conservative screening levels might be possible if screening levels were based on empirical estimates of long term attenuation factors, using long term mean estimates of groundwater concentration.

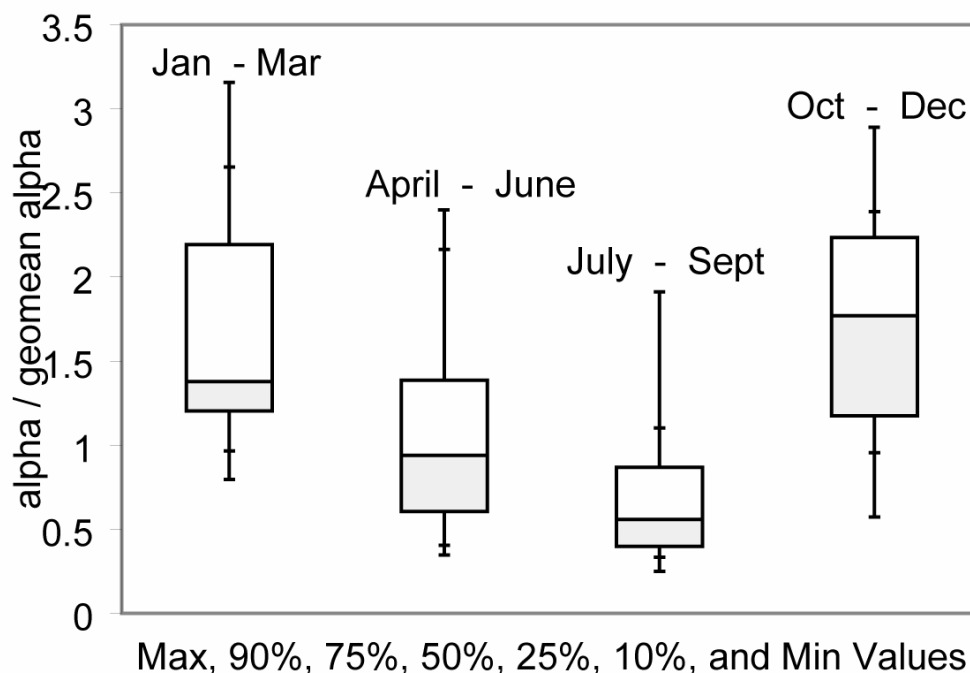

Figure 8. Seasonal variations in attenuation factor

More case history data with long term indoor air and groundwater monitoring data is required to develop an adequate database of long term attenuation factors for screening level development.

More research is required to evaluate the temporal effects of groundwater fluctuations on soil vapor flux. We might find that, in many cases, soil vapor flux is relatively insensitive to short term fluctuations, meaning that more emphasis should be placed on establishing long term mean concentrations of groundwater.

REFERENCES

- CDPHE (Colorado Department of Public Health and Environment), 2000. Guidance for Analysis of Indoor Air Samples. Hazardous Materials and Waste Management Division, Revised April 2000, available at <http://www.cdphe.state.co.us/hm/airsmpl.pdf>
- Eklund, B., Folkes, D., Kabel, J., and Locke, S. 2006. Understanding Different State Approaches to VI. Proc. Air & Waste Management Association Specialty Conference on Vapor Intrusion, Los Angeles, Sept. 13-15, 2006, 20-33.
- EPA (U.S. Environmental Protection Agency), 1992. Supplemental Guidance to RAGS: Calculating the Concentration Term. Office of Solid Waste and Emergency Response, Washington DC 20460, Publication 9285.7-081, May 1992.
- EPA (U.S. Environmental Protection Agency), 2004. User's Guide for Evaluating Subsurface Vapor Intrusion. Office of Emergency and Remedial Response, Washington, DC 20460.
- EPA (U.S. Environmental Protection Agency), 2002. Draft Guidance for Evaluating the Subsurface to Indoor Air Vapor Intrusion Pathway. Office of Solid Waste and Emergency Response, November 29, available at <http://www.epa.gov/correctiveaction/eis/vapor.htm>
- Folkes, D.J. and Kurz, D.J. 2002. Efficacy of Sub-Slab Depressurization for Mitigation of Vapor Intrusion of Chlorinated Organic Compounds. Proc. Indoor Air 2002, Monterey, CA, available at <http://www.envirogroup.com>.
- Hers, I., Dawson, H. and Truesdale, R. 2006. Status of Generic Screening Levels – Update on Empirical Vapor Attenuation Factor Analysis. Presented at EPA/AEHS Summary Workshop in the Context of EPA's VI Guidance Revisions, San Diego, March 16, 2006. Available at <http://iavi.rti.org>.
- Johnson, P.C. and Ettinger, R.A. 1991. Heuristic Model for Predicting the Intrusion Rate of Contaminant Vapors into Buildings. Environ. Sci. Technol. Vol. 25, No. 8, 1445-1452.
- Johnson, P.C., 2005. Identification of Application-Specific Critical Inputs for the 1991 Johnson and Ettinger Vapor Intrusion Algorithm. Ground Water Monitoring & Remediation 25, No. 1, 63-78.
- Kurtz, J.P. and Folkes, D.J. 2002. Background Concentrations of Selected Chlorinated Hydrocarbons in Residential Indoor Air. Proc. Indoor Air 2002, Monterey, CA, available at <http://www.envirogroup.com>.

- Schuver, H. 2006. Role of Modeling & General Status of Revisions to EPA's 2002 Vapor Intrusion Guidance. Presented at EPA/AEHS Summary Workshop in the Context of EPA's VI Guidance Revisions, San Diego, March 16, 2006. Available at <http://iavi.rti.org>.
- Wertz, W. 2006. Near-Building and Subslab Sampling at the Endicott (NY) Site, Implications for Site Screening Approaches: Parts I and II. Presented at EPA/AEHS Summary Workshop in the Context of EPA's VI Guidance Revisions, San Diego, March 16, 2006. Available at <http://iavi.rti.org>.

Chapter 38

THE USE OF TRACER GAS IN SOIL VAPOR INTRUSION STUDIES

Peter A. Reynolds

URS Corporation, 201 Willowbrook Boulevard, Wayne, N J 07470

Abstract: There has been a rapid rise in the need for soil vapor intrusion (SVI) assessments to meet environmental compliance requirements regarding brownfields development and asset improvement in both the commercial and private sectors of the marketplace. As these requirements become more pervasive throughout the country, planners and stakeholders are approaching environmental professionals for solutions.

Our approach to SVI sub-slab testing for existing structure interiors incorporates a tracer gas monitoring technique that has proven to be very cost effective. This method allows for the verification that the sample collected from beneath an impervious surface is truly isolated from the ambient air inside the building. Implementation of this method has met with the approval of New York regulators and is consistent with their Soil Vapor Intrusion Guidance, which was published in 2005.

1. INTRODUCTION

Sub slab samples are typically collected by drilling through the impervious surface, slightly into the material below the slab, installing a sample probe, sealing the probe from the area above the slab, and purging the sampling probe at low flow rates (typically at or below 200cc/min). The potential exists for unchecked leakage of ambient air into the subslab soil vapor sampling zone. Because of this condition, the need to measure the potential influence of ambient air on a discrete subslab sample was identified. Researchers recommended the use of tracer gas to detect and measure potential ambient air intrusion into the subslab sampling space:

“When collecting soil vapor samples as part of a vapor intrusion evaluation, a tracer gas serves as a quality assurance / quality control device to verify the integrity of the soil vapor probe seal. Without the use of a tracer, there is no way to verify that a soil vapor sample has not been diluted by surface air.”¹

General guidance suggest a few techniques for using tracer gas for sub slab sampling including the use of tracer gas shrouds and plastic sheeting to contain the tracer gas above the sampling point. This sampling method is intended as an application of the suggested tracer gas procedure using commonly available equipment.

2. APPLICABILITY/ASSUMPTIONS

This is considered an active vapor sample collection method. This technique pertains to the withdrawal and collection of soil gas vapors by vacuum for immediate screening and subsequent laboratory analyses. This method may be used with an assortment of ground probes as a means to

estimate the level of isolation of the subslab soil vapor sample from the ambient air to detect and control potential short circuiting from a poor annular seal.

This sampling method is principally intended to be used for the collection of Volatile Organic Contaminants (VOCs) from subslab media to SUMMA canisters for subsequent analyses by EPA TO-15. Subslab samples are considered to be taken at depths of 5 feet or less.

3. DESCRIPTION OF METHOD

An inert tracer gas is used to first blanket the surface of the slab and a gas tight seal is formed between atmosphere and the sub-slab sample targeting point, sometimes just inches below the ambient space. The sample point is isolated with a small enclosure that is then charged with the tracer gas until the gas concentration exceeds 80%. The isolated sampling point below grade is then purged and tested for the same tracer gas to measure the potential for sampling influence (or bias) from the ambient space above. Once it has been determined that the target sample is relatively free from bias (by a measured tracer gas concentration of 10% or less), sampling proceeds. The tracer gas blanket and sampling space are monitored throughout the sampling period to ensure that the potential for ambient air to migrate into the sampling zone is minimized.

Helium is used as a tracer gas due to its availability and ease of detection. The approach to using tracer gas to measure sample isolation incorporates the use of a portable enclosure equipped with a soft gasket similar to the type suggested in the guidance, with the following improvements:

- The enclosure is equipped with a replaceable rubber grommet to greatly reduce the migration of helium out of the enclosure by minimizing leakage from around the sampling line protruding from the top of the enclosure.
- The enclosure has a gas tight quick connect port located at the top for the introduction of helium.
- A gas tight quick connect port is also installed close to the base of the enclosure to act a purge valve during the exchange of ambient air with helium, and to serve as a monitoring port for direct connection to the helium detector.
- The soft gasket on the base of the enclosure is roughly ½ inches thick and seals well on rough and uneven surfaces such as brick or asphalt.

The enclosure can be rapidly set up and broken down, and eliminates the use and subsequent cleanup of wet sealers.

4. TYPICAL SAMPLING PROCEDURE

The sampling procedure used in most applications is listed below:

1. A hole is drilled or cored through the slab 3 to 6 inches into the subsurface material or void space beneath the slab.
2. A ¼-inch sampling tube attached to a stainless steel sampling screen is advanced through the hole. Sand (Morie No. 1 or No. 2) is added to surround and cover the sampling zone.
3. The sampling point is isolated from the atmosphere above by the use of modeling clay or beeswax (for small diameter holes) and grout or hydrated bentonite for larger holes.
4. The ¼-inch OD sample tube is passed through the enclosure, the enclosure is placed over the sampling point, and weights are added to the enclosure to compress the gasket between the enclosure and the slab.
5. The lower helium port is opened, and the upper port is connected via a ⅛ inch Teflon line to the helium supply.

6. Helium is introduced through the upper port and the air is allowed to escape through the lower port.
7. The concentration of helium is directly measured at the lower port until the concentration reaches at least 80 percent, then both ports are closed.
8. The helium detector is operated in ambient air to clear the unit of helium.
9. Using a portable pump, the sampling tube is purged at 200 cc/min to remove approximately three volumes of air within the sampling tube and the sampling point.
10. A Tedlar bag is connected to the exhaust port of the sampling pump, and a sample is collected to measure helium. The helium concentration inside the bag is measured. If the helium concentration is 10 percent or less, sampling is allowed to proceed. If the helium concentration is greater than 10 percent, then the seal to atmosphere is checked and/or repaired and the process is repeated.
11. The sampling tube is directly connected to a certified clean SUMMA canister provided by the laboratory, and then a sample is collected following the laboratory's Standard Operating Procedures.
12. Sampling may be interrupted to monitor the presence of tracer gas in the sample depending on the sampling duration, but for short sampling periods (1-hour or less), a minimum of a final tracer gas check should be performed. If the enclosure loses a significant amount of helium over the sampling point it may be recharged and the short circuiting check repeated.

5. RECOMMENDED EQUIPMENT

In addition to the enclosure described above, the following equipment is recommended to perform the sampling method.

5.1 Helium Tracer Gas

Technical grade helium is used as a tracer gas. Refill helium is a readily available and economical choice for this use. Typically, empty tanks are exchanged for full tanks by the helium supplier. One 20 cubic foot helium tank is roughly 20 inches tall and weighs about 10 pounds, and will cover at least four sampling locations. For sites with numerous sampling points, larger tanks may be used; however, these tanks must be secured to a tank cart when being transported around the site.

One must consider proper safety procedures for tank storage, transfer, and handling. Helium is a simple asphyxiant, as such, safety measures, such as properly protecting the cylinder valve and securing the gas cylinder must be performed. A broken valve could turn the pressurized cylinder into a dangerous projectile. The cylinder should never be transported within the passenger compartment of a vehicle without plenty of ventilation, and the cylinder should be secured by straps during transport.

The use of a gas regulator is highly recommended for the safe discharge of helium to the enclosure. Gas delivery and control are controlled by the regulator and a needle valve connected to the helium cylinder via a Compressed Gas Association (CGA) No. 580 fitting. A valve or toggle switch at the regulator outlet is easier to operate than the bottle valve alone. Pipe tape should not be needed for the connection, but is good to have on hand if fitting on your particular tank has been worn.

5.2 Helium Detector

The portable helium detector used in this application is a Radiodetection Dielectric Technologies Model HDP 9900. The instrument uses Thermo Conductivity Detection to measure helium concentrations. Used in historical gas chromatography experiments, the Thermo Conductivity Detector (TCD) consists of two matched thermistors, one exposed to the sample gas stream, the other employed as a reference current. During instrument operation, the two thermistors are compared for their difference in output, and this difference is amplified and reported as a response.

To reduce interferences caused by moisture, carbon monoxide, carbon dioxide, ozone and the potential presence of ambient VOCs, the detector is equipped with a replaceable moisture trap which contains indicating silica gel, molecular sieve, activated carbon and other filtering media. Additionally, the detector is equipped with High Efficiency Particulate Air filters to protect its internal components.

It is important to note that the typical sampling flow rates for this detector may exceed 500 cc/min. Therefore, the direct connection of the helium detector to the sampling line is not recommended. The use of a personal pump connected to a Tedlar bag for subsequent tracer gas monitoring is suggested to prevent over purging of the sampling point.

5.3 Purge Pump

For sample purging, a personal pump (SKC Model 224-PCXR4 or equivalent) commonly employed in industrial hygiene monitoring activities is used. These pumps typically run for eight hours on a single battery charge cycle and are capable of maintaining a stable 200cc/min flow rate over time. For the referenced pump, a low range is set on the pump flow regulator and fine adjusted by use of an inlet valve. Pump designs and capabilities vary, so the user should performance test any new pump system prior to sampling. Also, these pumps have a potential to fail during field activities due to a variety of conditions (obstructions, low batteries, etc.) so the use of a back up pump is recommended.

The personal pump is calibrated by use of a dry flow calibrator (BIOS DCL-ML or equivalent). The outlet port of the calibrator is connected to the inlet port on the pump, the pump is started, and the inlet needle valve is adjusted until a 200cc/min air flow is maintained. It is recommended to check the purge rate repeatedly during purging and/or sampling activities to verify that the flow has not changed significantly.

5.4 Other Equipment Considerations

Dedicated, disposable equipment should be used to prevent cross contamination between sampling points. A general equipment list is provided below:

1. Disposable Nitrile gloves.
2. Fresh Teflon tubing for each sampling point ($\frac{3}{8}$ in. ID X $\frac{1}{4}$ in. OD).
3. Tedlar Bags equipped with inlet valves (SKC 232-03 or equivalent).
4. Sealing Materials such as modeling clay, grout, beeswax and bentonite.
5. Gas Tight fittings for sample line connections (Swagelok).

Table 1. Typical Swagelok Fittings

| Description | Swagelok Part No. | Approx. Unit Cost (USD) |
|--|-------------------|-------------------------|
| $\frac{1}{4}$ in. nut (each) | SS-402-1 | 1.37 |
| $\frac{1}{4}$ in. ferrule sets (100) | SS-400-Set | 126.00 |
| $\frac{1}{4}$ in. union | SS-400-6 | 7.31 |
| $\frac{1}{4}$ in. Tee | SS-400-3 | 16.12 |
| $\frac{1}{4}$ in. Plug | SS-400-P | 3.91 |
| $\frac{1}{4}$ in. Cap | SS-400-C | 4.30 |
| $\frac{3}{8}$ in. to $\frac{1}{4}$ in reducing union | SS-600-6-4 | 13.30 |

6. QUALITY ASSURANCE CONSIDERATIONS

In addition to the use of tracer gas to determine the contribution of ambient air to the subslab sample, the following Quality Assurance (QA) measures are recommended.

6.1 Ambient (background) Air Samples

Ambient air samples collected in the area above the subslab sampling location are recommended as a means to compare sampling results with background conditions.

- For building interior subslab sampling, at least one ambient air sample should be collected from above each sub surface study area within the building.
- At least one ambient air sample should be collected from an area outside the building.

6.2 Duplicate Samples

Duplicate sampling is recommended to measure the precision of the sampling and analytical technique. Duplicate samples should be collected at a frequency of at least 5 percent. Duplicates are collected by the use of a stainless steel tee connecting two Summa Canisters to a common flow controller.

6.3 Additional QA Considerations

Additionally, the following quality control measure considerations are recommended when collecting soil vapor samples:

1. Usually the area beneath the building is comprised of open voids or loose fill. As such, the vacuum created by sample pumps would be considered to be negligible. However, sampling consolidated soils beneath the slab may produce a vacuum. Suspect sampling points should be monitored with an in-line vacuum gauge.
2. Consider the elevation of neighboring sample points and the horizontal pathway to the sampling point. Dips in the surface material could also cause short circuiting.
3. Mark out underground utilities and identify the potential for soil vapor migration. As-built drawings are very useful for this purpose.
4. Building survey forms should be completed to determine possible contribution to sample results from stored products and human activity.
5. Interior and ambient air pressures and temperatures should be recorded during the sampling period.
6. Whenever possible, sampling activities should be scheduled around work activities in an occupied building.
7. A steady state should be maintained in building interior by minimizing or eliminating door movement, exhaust fan operation, etc.
8. The groundwater elevation below the slab should be accurately determined or at least estimated when choosing the sampling depth.

7. CONTRACTOR PREPAREDNESS

Drilling through concrete and asphalt is normally accomplished with a construction grade hammer drill and masonry bit available at most equipment rental centers. However, for special applications, a drilling contractor may be required.

Drilling contractors use different methods for sample probe installation. It is important that your drilling contractor is comfortable with your scope of work and will be capable of stocking and deploying the sampling train that you specify. This could be as simple as an angle cut tube for site screening or as complex as a permanent vapor sampling well for long term studies. Allow planning time to ensure that your drilling contractor will:

1. Have a clear understanding of your work scope.
2. Use clean sampling point installation procedures.

3. Have the ability to mobilize in tight urban situations.
4. Be flexible with regard to unexpected building construction and environmental conditions, which may require additional equipment.

Drilling is preferred due to the reduced diameter of the hole and a minimum amount sealing of materials used. However, coring gives the site investigator the option of obtaining discrete soil samples at multiple depths below the floor which could be used for further site characterization. Most concrete coring activities employ water as a coring bit coolant. Care should be taken to ensure that the sampling point has not been exposed to heat and/or moisture. It is recommended that cored sampling points are kept dry and allowed to cool down. The sampling point should be installed, sealed to the atmosphere (by use of a gas tight plug) and allowed to stand prior to sampling, preferably over night.

8. SUMMARY

The use of tracer gas for the purpose of obtaining representative subslab samples has been considered and recommended by a growing number of members of the regulatory community. The use of a portable helium enclosure is a fast, effective, economical sub slab sample isolation monitoring technique that can be deployed under a variety of sampling environments. This method has been used to perform the technique rapidly while addressing the need to collect a discrete, representative sample. Tied to a technically sound scope of work, this subslab sampling method addresses the detection and control of short circuiting under a variety of field conditions.

REFERENCES

1. Guidance for Evaluating Soil Vapor Intrusion in the State of New York: Public Comment. Draft February 2005.
2. United States Department of Environmental Protection OSWER Draft Guidance for Evaluating the Vapor Intrusion Pathway from Contaminated Soils (Subsurface Vapor Intrusion Guidance). EPA530-D-02-004. November, 2002.
3. New Jersey Department of Environmental Protection Field Sampling Procedures Manual. August 1995.
4. New Jersey Department of Environmental Protection Vapor Intrusion Guidance. October 2005.
5. US EPA. Compendium Method TO-15, Determination of Volatile Organic Compounds (VOCs) in Air Collected in Specially Prepared Canisters and Analyzed by Gas Chromatography/Mass Spectrometry (GC/MS). In: Compendium of Methods for the Determination of Toxic Compounds in Ambient Air, 2nd Edition. EPA/625/R-96010b. January 1999.

Index

- 1,1-dichloroethylene 373
- acid mine drainage 1, 9-11, 18, 19
- aggregate type 219
- air/ozone sparging 301, 307, 308, 310-312
- aluminum processing plant 119, 129, 131, 134
- anaerobic 227, 228, 231, 239, 246
- anerobic biostimulation 231
- anthrazene 213
- anthropogenic 51-53, 56, 59
- antimony 149, 151, 153-158
- aquifer materials 291-295, 298
- arsenate 267-271
- arsenic 45, 51, 61-64, 67-69, 71-75, 77- 80, 82-88, 97, 267, 271, 272
- arsenic background 51
- arsenite 267-271
- asbestos 83-86, 89, 90, 97, 347
- Atsion soil 319, 321-324
- attenuation factor 371
- Bacillus* 137, 138, 142-145
- background 51-53, 56-59, 61, 77, 78, 80-82, 197, 198, 200
- bacteria 137, 146, 189, 193, 194
- bathymetry 249, 262
- benzo(a)pyrene 85, 94, 95, 97
- bioaugmentation 219
- bioavailability 319, 320, 324-326
- biodegradation 219, 228, 247, 287-290
- biodiesel 159
- biological modeling 335
- bioremediation 101, 105, 106, 219-225
- brine 163, 164, 169-173
- brownfield 83, 347, 359, 364, 365, 371, 383
- BTEX 213
- bulking agent 219
- Canada 107, 109, 116
- carcinogenic polynuclear aromatic hydrocarbons 83
- cement 273
- CERCLA 360, 361, 363, 364, 367, 369, 371
- characterization contamination 197
- chemical weathering 149-151, 154-157
- chlorinated phenolic compounds 213
- chlorinated volatile organic compounds 360
- clay 273
- conceptual site model 349, 350, 352
- contaminated soil 45, 267, 268, 271, 319, 320, 324
- contamination 205, 206, 208
- creosote 213
- CSM 349, 350, 352, 355, 357, *See* conceptual site modeling
- CVOC 349, 353, 356
- CVOCs 359, 360, 362, 367, *See* chlorinated volatile organic carbons
- Daubert* 359, 362, 363, 368
- DCE 371, 373-375, 379, *See* 1,1-dichloroethylene
- debris removal 249, 261
- decomposition kinetics 291
- dermal exposure risk 319
- dioxins 83, 85
- disposed waste 119
- downhole video camer 301
- drinking water 163
- electrochemical destruction 163
- EPA 371-374, 376, 377, 379-382
- explosive compounds 175, 177
- external exposure 206
- fish advisories 331, 333, 334
- Florida 335
- fluorine 213
- fluoropolymers 327
- Former Herbicide Blending Facility 45
- fractured bedrock 349, 350, 355
- geochemical modeling 11, 12, 14, 16, 18, 19
- geochemistry 61
- geographic distribution 331
- geophysics 349, 354, 357
- greenhouse experiment 267
- groundwater 61-64, 67, 71, 73-75, 101, 103, 104, 163, 169, 213, 215, 227, 349, 350, 355, 356
- groundwater monitoring 373, 374, 376, 381

- groundwater remediation 227
groundwater transport 201
growth kinetics 137, 145
gypsum 273-275, 277
- H₂S *See* hydrogen sulfide
Habitat Equivalency Analysis *See* HEA
Haldane type inhibition 137
HEA 335, 338, 339
heavy metals 1, 7, 83, 101, 107, 116, 119-123, 128, 134, 249, 258
helium 384-386, 388
heterogeneity 349
hexavalent chromium removal 137
HMX 175, 177-179, 181, 182
hydraulic dredging 249, 250
hydrocarbons 273, 276, 280-283, 286
hydrogen sulfide 249, 259, 260, 261
hydrothermal alteration 149-151, 155, 158
- Ichinokawa 149-158
in situ chemical oxidation 291, 299
indoor air 371-377, 379-381
indoor air tests 371, 376
indoor radon 201
industrial activities 249
ingestion of food 207
ingestion of groundwater 207
ingestion of oil 207
inhalation 206, 209, 210
initial contaminant concentration 219
innovative remedial process 301, 302
instability 159
ion-exchange 163, 171, 173
ion-exchange regenerant brines 163
iron 61, 68, 71-73
iron hydroxide 149, 152, 158
- keyport soil 319, 321, 323, 324
- laboratory 20-22, 24, 25, 29, 30, 33-35
landfill 101-106
lead 83-86, 88, 93, 94, 97, 99, 119-123, 128, 129, 131, 132
lime 273, 277, 285, 286
litigation 359
long term monitoring 371
long-term passive bioreactors 1
- magnesium sulfate 227
manganese 61, 71, 73
manufactured gas plant sites 319, 320
marine 249, 250, 259
marine hydraulic dredging 249
Massachusetts Contingency Plan 61, 63, *See* MCP
MassDEP 20-24, 26-29, 33-36
mathematical-modeling 137
matrix effects 319
MCP 61, 63, 64, 71, 75
measurements 119, 125
mercury 101-104, 106, 331-334
mercury mine 119, 120, 123, 125, 132, 135
- methyl esters 159
microbial route 137
middle distillate 159
mine tailings 107, *See* tailings
mineralogical analysis 1, 3, 4
mining industry 107, 108
monitored natural attenuation 231, 235
monitoring 11, 14, 18
MPG sites 213
MTBE 301, 302, 307, 310, 312, 316, 317
Muni well protection 301
- naphthalene 213
natural resource damage assessment 335, 344
naturally occurring arsenic. 61
New Bedford harbor 249
NRDA 335, 337, 339, *See* natural resource damage assessment
- oil spill 335, 344
organic hydrocarbons 213, 215, 216
organoclay 213-216, 218
- PAHs 83-86, 94, 95, 97, 319, 324, 326
PCBs 213, 216, 249, 250, 253, 256, 258, 259, 347
PCP 213, 215
perchlorate 163-166, 169, 171-173, 175-179, 181, 182, 184-187, 189, 191--195
perfluorooctanoic acid 327
permeable barriers 213
persulfate 291-296, 298, 299
pesticide manufacturing plant 52
pesticides 52, 213, 215, 216, 218
petroleum 159, 227, 228, 231, 239, 246, 247, 273, 301, 307, 309
petroleum hydrocarbon compounds. 273
petroleum hydrocarbons 287, 288, 289
petroleum refineries 319
PFOA *See* perfluorooctanoic acid
phenanthrene 319-325
physical fates 335
phytoextraction 267, 270
phytovolatilization 267, 268
pilot-scale 175
planned residential development 77
PNAH 213
polluted sites 119
polychlorinated biphenyls 83, 249, *See* PCBs
polycyclic aromatic hydrocarbon 319, 320
polynuclear aromatic hydrocarbons 83
Portland cement 107-109, 111, 112, 116, 117
process improvement 175
Pseudomonas 137, 138, 142-146
Pteris vittata 267
pyrene 213
- radioactive 205-207
radioactive soil 197
radioactivity 197, 205
rainfall 201, 202
RDX 175, 177, 178, 181, 182
remediate 227

- remediation 273, 285, 286, 301, 307-309, 311
- removal 163
- Republic of Slovenia 119, 122, 134, 135
- risk assessment 77
- risk-based management 83

- safety 249, 259-261
- screening level 205
- sediment 213, 215, 249-251, 256, 258-262, 264, 265
- sediment stabilization 213
- SIMAP 335-337, 339, 340, 344
- skin 319-325
- Slovak Republic 11-13, 18, 19
- soil 51, 77-80, 82, 101-104, 106, 175, 197-200, 205, 207, 209, 210, 212, 273
- soil aging 319
- soil gases 201
- soil reagent mixing 273
- soil remediation 175, 182
- soil type 319, 321
- soil vapor intrusion 383
- soil-aged 319
- solidification 273, 285, 286
- soy cooking oil 159
- soybean derived fuel 159
- Spill Impact Model Analysis Package *See* SIMAP
- SRB *See* sulfate reducing bacteria
- SRM *See* soil reagent mixing
- stabilisation 273, 285, 286
- stibnite 149-152, 157
- sub-slab testing 383
- sulfate 227, 229-232, 235, 236, 238-240, 242, 244, 246
- sulfate-reducing bacteria 1
- sulphate-reducing bacteria 10

- Superfund site 45, 249
- surfactant 287, 288
- SVI *See* soil vapor intrusion

- tailings 107-117
- tannery waste 137
- target value 205
- thermal treatment 175
- Tobe 149-155, 157, 158
- topographic site conditions 347
- total petroleum hydrocarbons 219-222, 224
- TPH 287, 289, 290, *See* Total petroleum hydrocarbons
- tracer gas 383-386, 388
- treatment 175-182, 184-187
- trends 11, 14, 15

- unconfined compression 107, 113
- uranium 119, 122, 126-128, 134
- urban fills 83
- USTs 302

- vapor intrusion 371-374, 380
- VOCs 20-22, 26, 28, 384, 386, 388
- volatile organic compounds 20-22, 276, *See* VOCs
- volatilization 267-270, 272

- watersheds 331, 332
- weathered oil 287, 288
- weathered rocks 153, 157
- wood preserving facilities 319

- zinc 119-122, 128, 131, 132